

## TABLE OF CONTENTS

1	<b>Before driving</b>	Adjusting and operating features such as door locks, mirrors, and steering column.
2	<b>When driving</b>	Driving, stopping and safe-driving information.
3	<b>Interior features</b>	Air conditioning and audio systems, as well as other interior features for a comfortable driving experience.
4	<b>Maintenance and care</b>	Cleaning and protecting your vehicle, performing do-it-yourself maintenance, and maintenance information.
5	<b>When trouble arises</b>	What to do if the vehicle needs to be towed, gets a flat tire, or is involved in an accident.
6	<b>Vehicle specifications</b>	Detailed vehicle information.
	<b>Index</b>	Alphabetical listing of information contained in this manual.

**1 Before driving**

**1-1. Key information**

Keys ..... 46

**1-2. Opening, closing and locking the doors**

Wireless remote control ..... 48

Side doors ..... 59

Tailgate ..... 63

**1-3. Adjustable components (seats, mirrors, steering wheel)**

Front seats ..... 67

Rear seats ..... 72

Head restraints ..... 75

Seat belts ..... 78

Steering wheel ..... 85

Inside rear view mirror ..... 86

Outside rear view mirrors ..... 88

**1-4. Opening and closing the windows**

Power windows ..... 91

Quarter windows (extra-cab models) ..... 94

Back window (vehicles with sliding type) ..... 95

**1-5. Refueling**

Opening the fuel tank cap .... 96

**1-6. Theft deterrent system**

Engine immobilizer system ..... 102

**1-7. Safety information**

Correct driving posture ..... 107

SRS airbags ..... 109

Child restraint systems ..... 122

Installing child restraints ..... 134

FarmaSOS.com

**2 When driving**

**2-1. Driving procedures**

Driving the vehicle ..... 146  
Engine (ignition) switch ..... 162  
Automatic transmission ..... 166  
Manual transmission ..... 170  
Turn signal lever ..... 173  
Parking brake ..... 174  
Horn ..... 175

**2-2. Instrument cluster**

Gauges and meters ..... 176  
Indicators and warning lights ..... 180  
Multi-information display ..... 185

**2-3. Operating the lights and wipers**

Headlight switch ..... 191  
Fog light switch ..... 195  
Windshield wipers and washer ..... 199  
Headlight cleaner switch .... 201

**2-4. Using other driving systems**

Cruise control ..... 202  
Rear view monitor system ..... 207  
Four-wheel drive system .... 212  
Rear differential lock system ..... 217  
Driving assist systems ..... 221  
DPF (Diesel Particulate Filter) system ..... 227

**2-5. Driving information**

Cargo and luggage ..... 232  
Winter driving tips ..... 235  
Trailer towing ..... 239



فارما سوس  
تلفن: ۰۲۱-۸۸۶۲۰۸۵  
FarmaSOS.com

**3 Interior features**

**3-1. Using the air conditioning system and defogger**

Manual air conditioning system ..... 252  
 Automatic air conditioning system ..... 258  
 Power heater ..... 265  
 Rear window defogger switch ..... 266

**3-2. Using the audio system**

Audio system types ..... 268  
 Using the radio ..... 270  
 Using the CD player ..... 275  
 Playing MP3 and WMA discs ..... 282  
 Operating an iPod ..... 290  
 Operating a USB memory ..... 300  
 Optimal use of the audio system ..... 309  
 Using the AUX port ..... 313  
 Using the steering wheel audio switches ..... 314

**3-3. Using the “touch screen”**

Touch screen ..... 317  
 Setup menu ..... 319  
 Audio system ..... 327  
 Using the radio ..... 331  
 Using the CD player ..... 336  
 Playing an audio CD and MP3/WMA discs ..... 337  
 Listening to an iPod ..... 350  
 Listening to a USB memory ..... 360  
 Using the AUX port ..... 369  
 Listening to Bluetooth® audio ..... 370  
 Using the steering wheel audio switches ..... 384  
 Hands-free system (for cellular phone) ..... 387  
 Using the Bluetooth® phone ..... 395  
 Setting the hands-free system ..... 411  
 Bluetooth® settings ..... 428

**3-4. Using the interior lights**

- Interior lights list ..... 438
- Personal lights ..... 439
- Interior light ..... 439

**3-5. Using the storage features**

- List of storage features ..... 440
- Glove box ..... 442
- Console box ..... 443
- Cup holders ..... 444
- Bottle holders ..... 446
- Auxiliary boxes ..... 447

**3-6. Other interior features**

- Sun visors ..... 449
- Vanity mirror ..... 450
- Clock ..... 451
- Ashtray ..... 452
- Cigarette lighter ..... 453
- Power outlet ..... 454
- Seat heaters ..... 455
- Floor mat ..... 457
- Compass ..... 459
- Deck hooks ..... 465

**4 Maintenance and care**

**4-1. Maintenance and care**

- Cleaning and protecting the vehicle exterior ..... 468
- Cleaning and protecting the vehicle interior ..... 472

**4-2. Maintenance**

- Maintenance requirements ..... 476

**4-3. Do-it-yourself maintenance**

- Do-it-yourself service precautions ..... 480
- Hood ..... 484
- Engine compartment ..... 486
- Tires ..... 503
- Tire inflation pressure ..... 507
- Wheels ..... 509
- Air conditioning filter ..... 511
- Wireless remote control battery ..... 513
- Checking and replacing fuses ..... 516
- Light bulbs ..... 532



**5 When trouble arises**

**5-1. Essential information**

Emergency flashers ..... 548  
 If your vehicle needs  
 to be towed ..... 549  
 If you think something is  
 wrong ..... 555  
 Fuel pump shut off  
 system ..... 556

**5-2. Steps to take in an emergency**

If a warning light turns  
 on or a warning  
 buzzer sounds ..... 557  
 If you have a flat tire ..... 565  
 If the engine will not start .... 584  
 If the shift lever cannot be  
 shifted from P ..... 585  
 If you lose your keys ..... 586  
 If the vehicle battery is  
 discharged ..... 587  
 If your vehicle overheats ..... 592  
 If you run out of fuel and  
 the engine stalls ..... 595  
 If the vehicle becomes  
 stuck ..... 596  
 If your vehicle has  
 to be stopped in  
 an emergency ..... 598

**6 Vehicle specifications**

**6-1. Specifications**

Maintenance data  
 (fuel, oil level, etc.) ..... 602  
 Fuel information ..... 623

**6-2. Initialization**

Items to initialize ..... 625

**Index**

**Abbreviation list ..... 628**  
**Alphabetical index ..... 629**  
**What to do if... ..... 639**

# امداد خودرو فارما

تلفن شبانه روزی: ۰۲۱-۸۸۸۶۲۰۸۵

[FarmaSOS.com](http://FarmaSOS.com)

1

2

3

4

5

6

**Single-cab models**

Windshield wipers P. 199

Side turn signal lights P. 173

Hood P. 484

Outside rear view mirrors P. 88

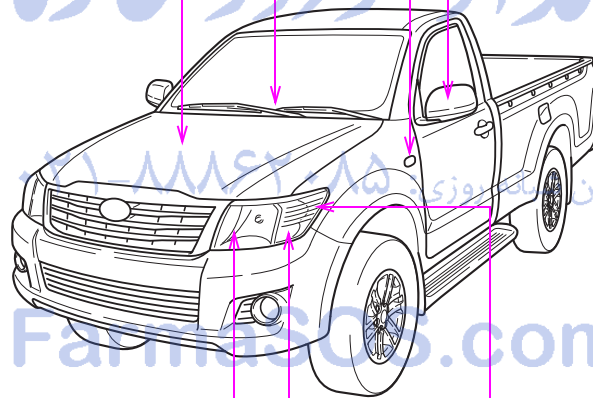

Headlights P. 191

Front turn signal lights P. 173

Front position lights P. 191



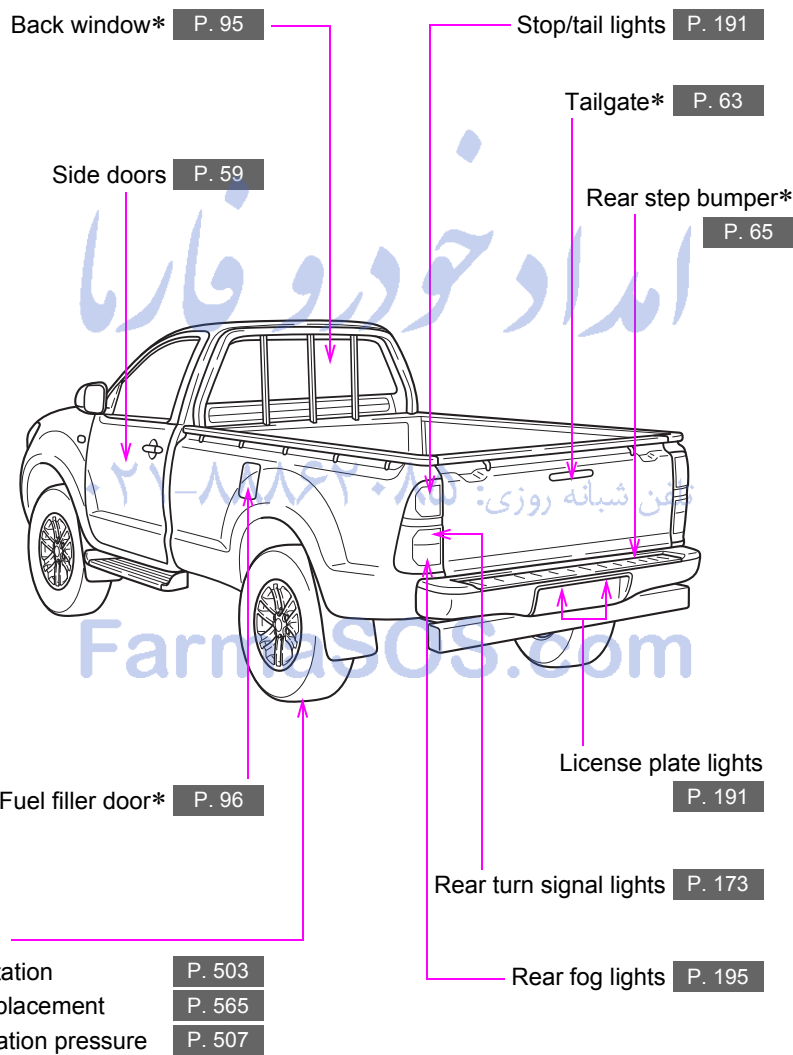

\*: If equipped

**Extra-cab models**

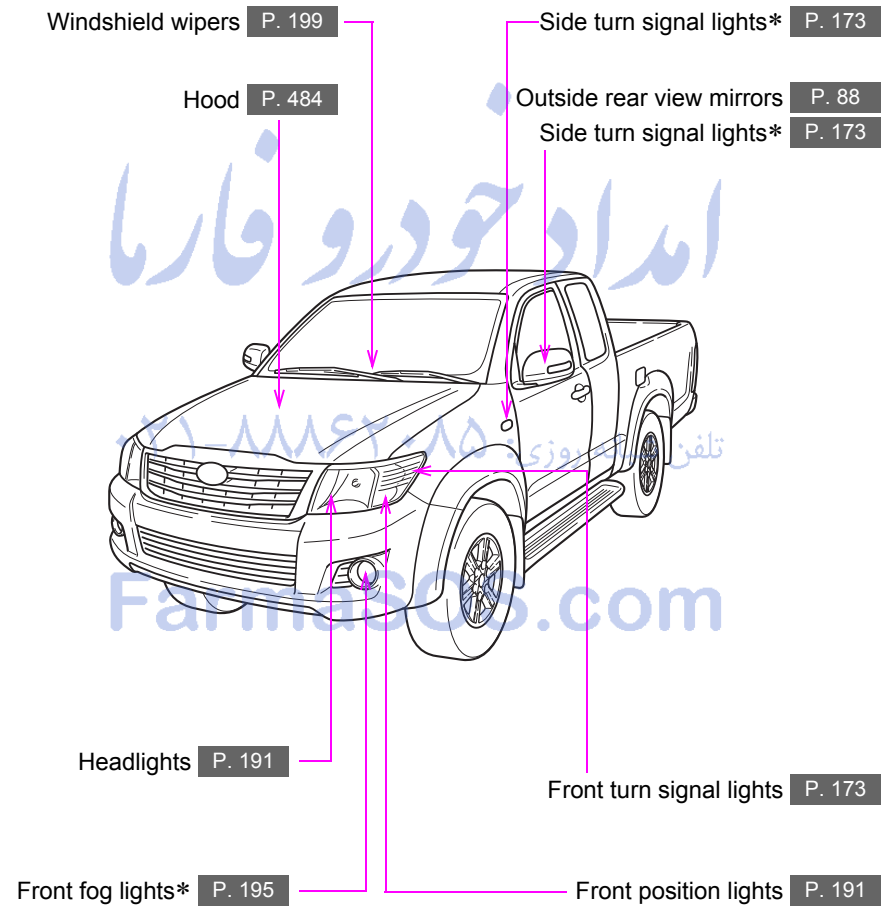

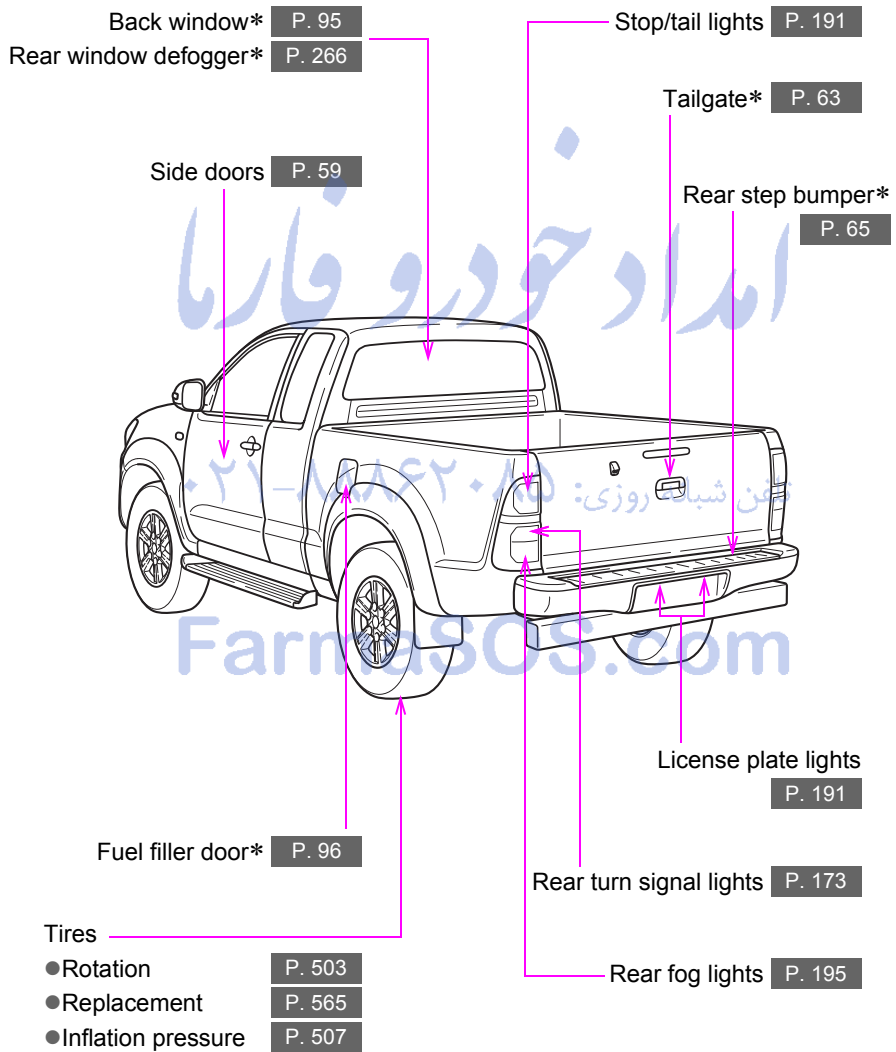

\*: If equipped

**Double-cab models**

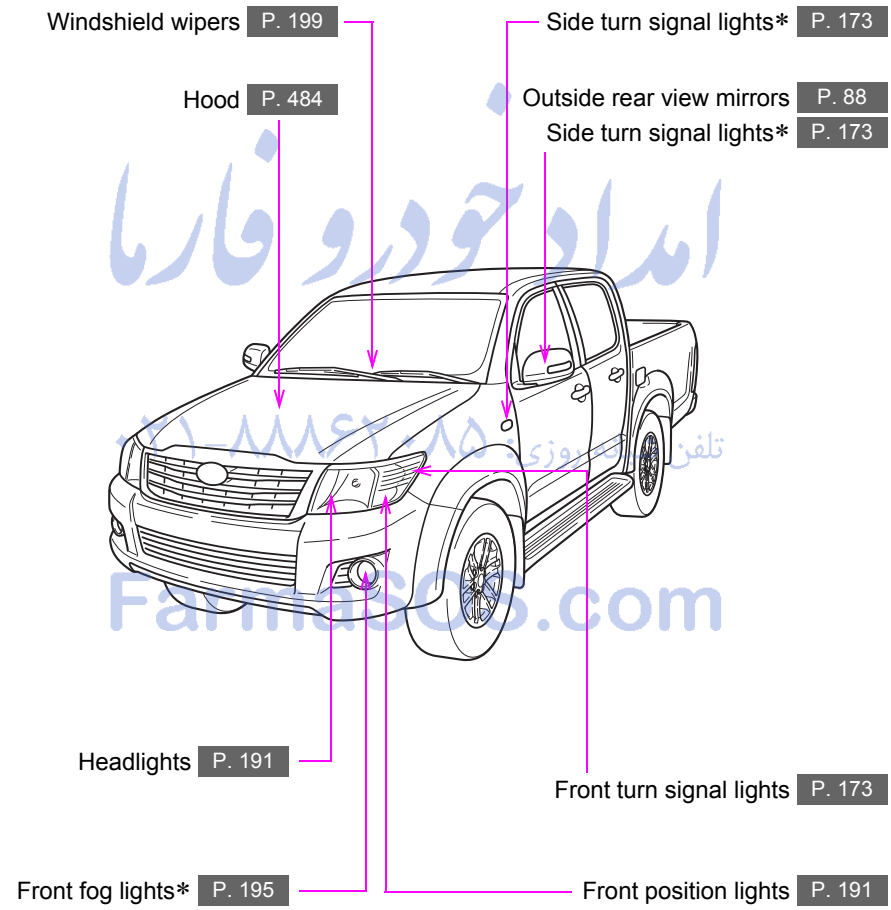

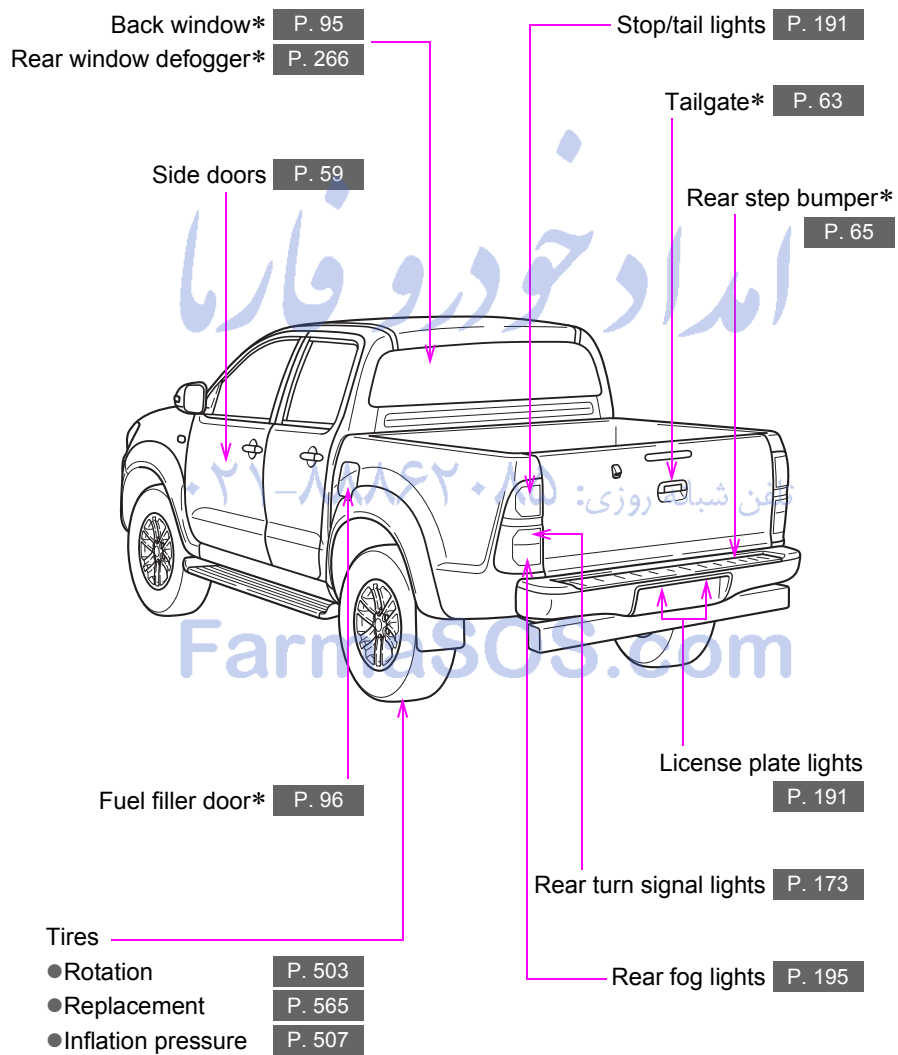

\*: If equipped

# Pictorial index

## Interior (Left-hand drive vehicles)

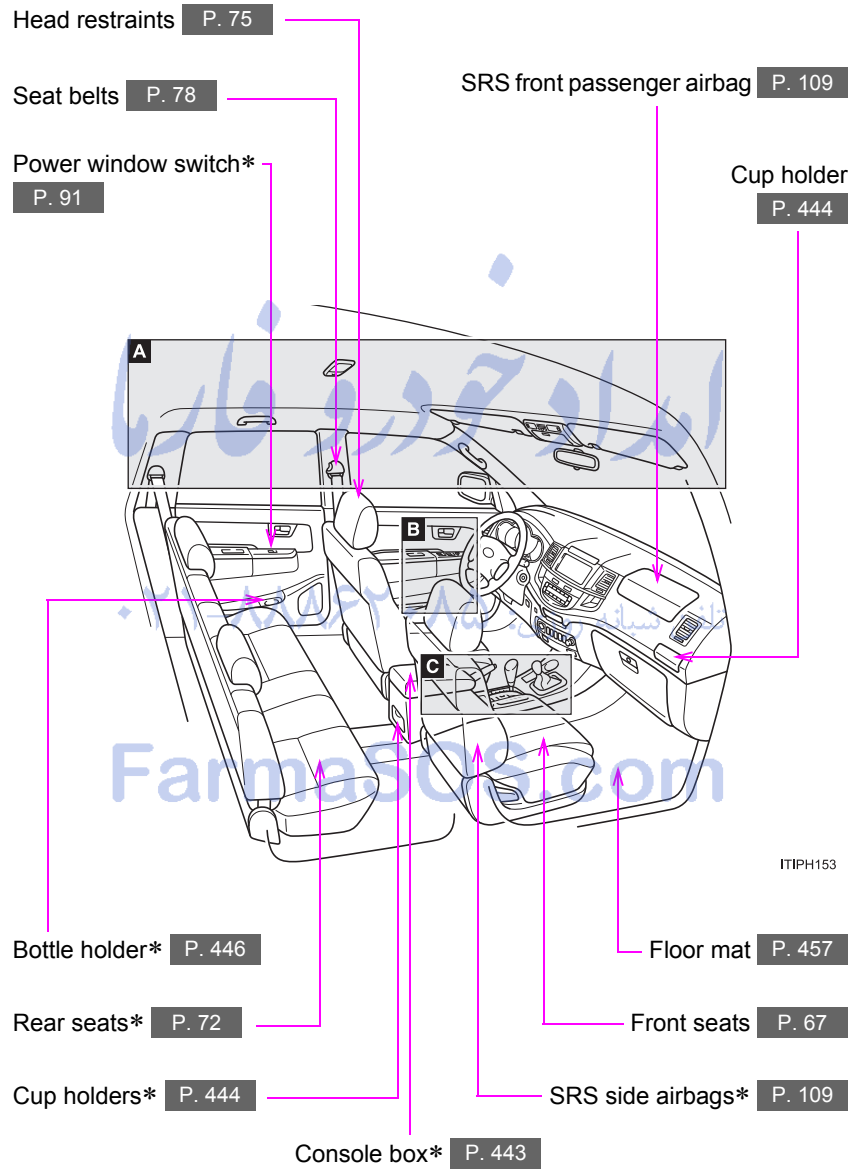

**A**

Interior light P. 439

Personal lights\* P. 439

Auxiliary box\* P. 447

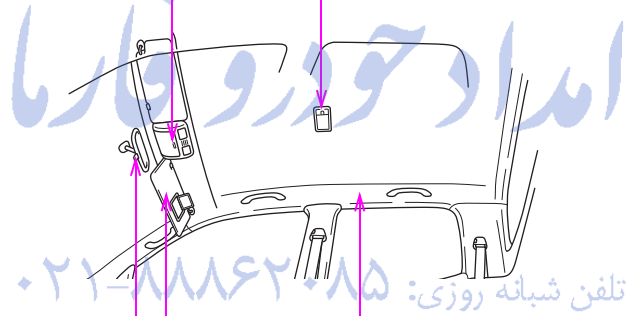

ITNPH008

SRS curtain shield airbags\* P. 109

FarmaSOS.com

Sun visors P. 449

Vanity mirrors\* P. 450

Anti-glare inside rear view mirror P. 86

\*: If equipped

**B**

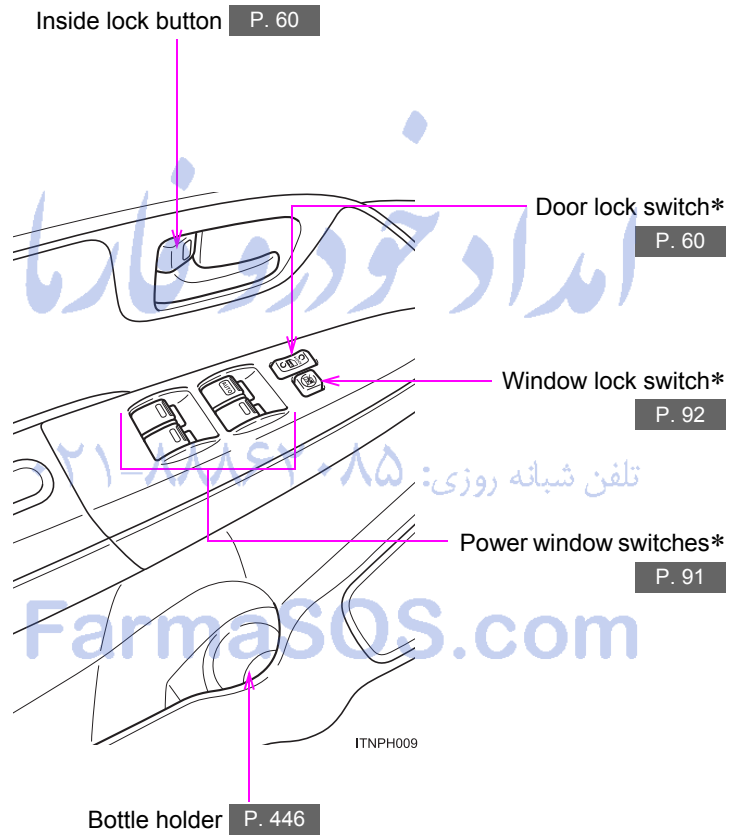



**C**

**Vehicles with automatic transmission**

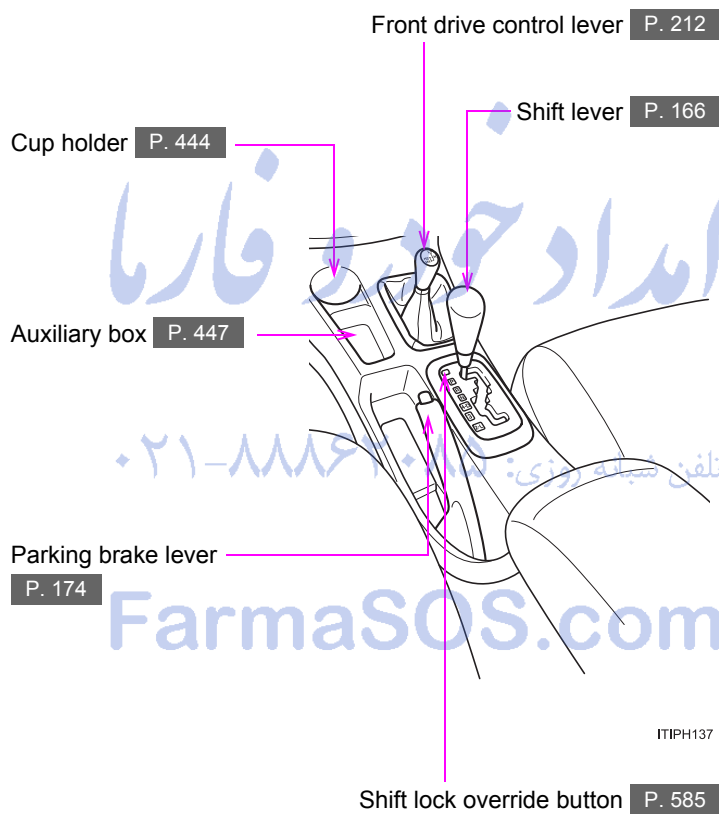

ITIPH137

\*: If equipped

**C**

**Vehicles with manual transmission**

Front drive control lever\*

P. 212

Auxiliary box P. 447

Shift lever P. 170

Parking brake lever

P. 174

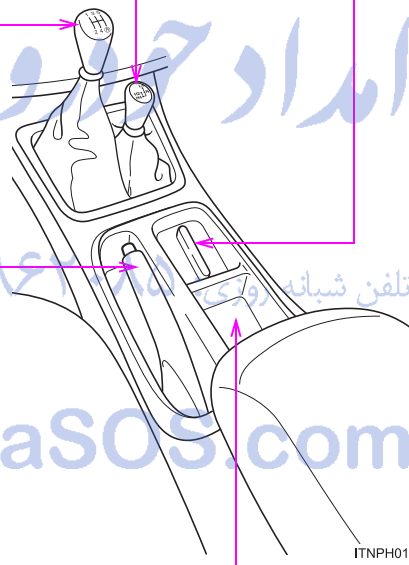

Cup holder P. 444

## Pictorial index

## Instrument panel (Left-hand drive vehicles)

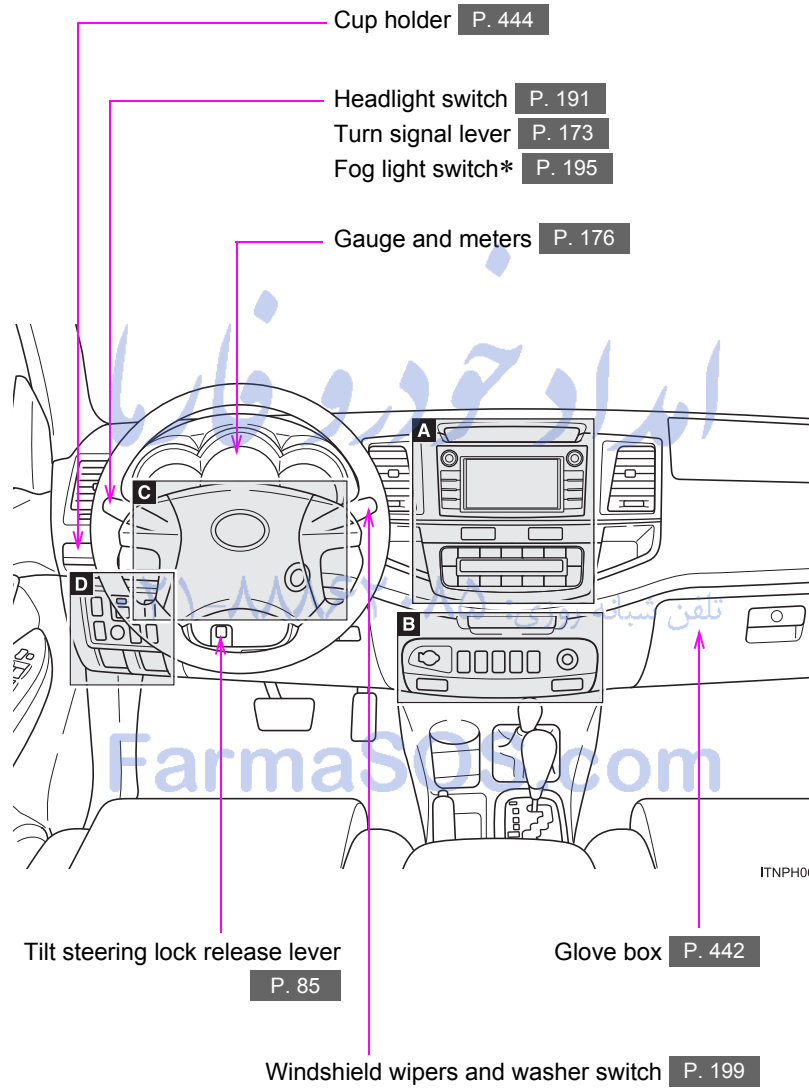

\*: If equipped

**A**

**Vehicles without automatic air conditioning system**

Audio system\*

P. 268, 327

Rear view monitor system\* P. 207

Front passenger's seat belt reminder light P. 561

Multi-information display\* P. 185

Clock P. 451

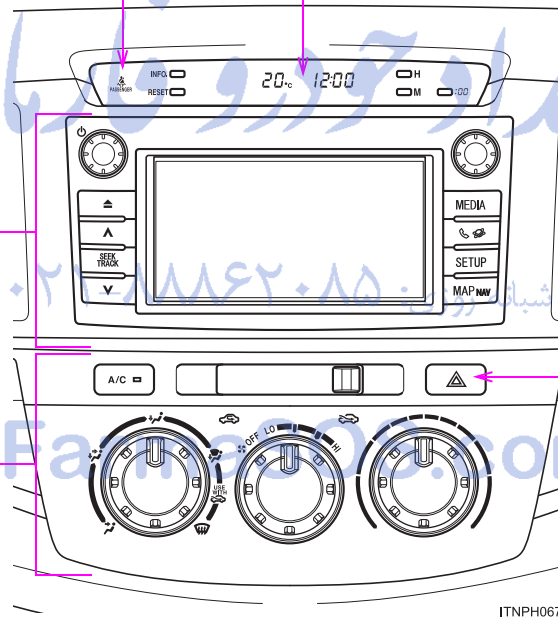

Air conditioning system P. 252

Emergency flasher switch P. 548

**A**

**Vehicles with automatic air conditioning system**

Audio system\*

P. 327

Rear view monitor system\* P. 207

Front passenger's seat belt reminder light P. 561

Multi-information display\* P. 185

Clock P. 451

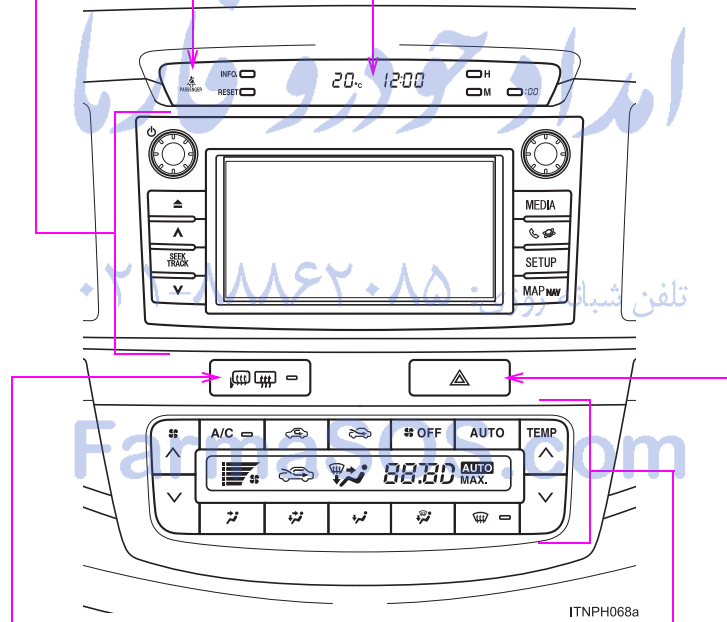

ITNPH068a

Rear window defogger switch\* P. 266

Air conditioning system P. 258

Emergency flasher switch P. 548

\*: If equipped

## Pictorial index

## Instrument panel (Left-hand drive vehicles)

**B**

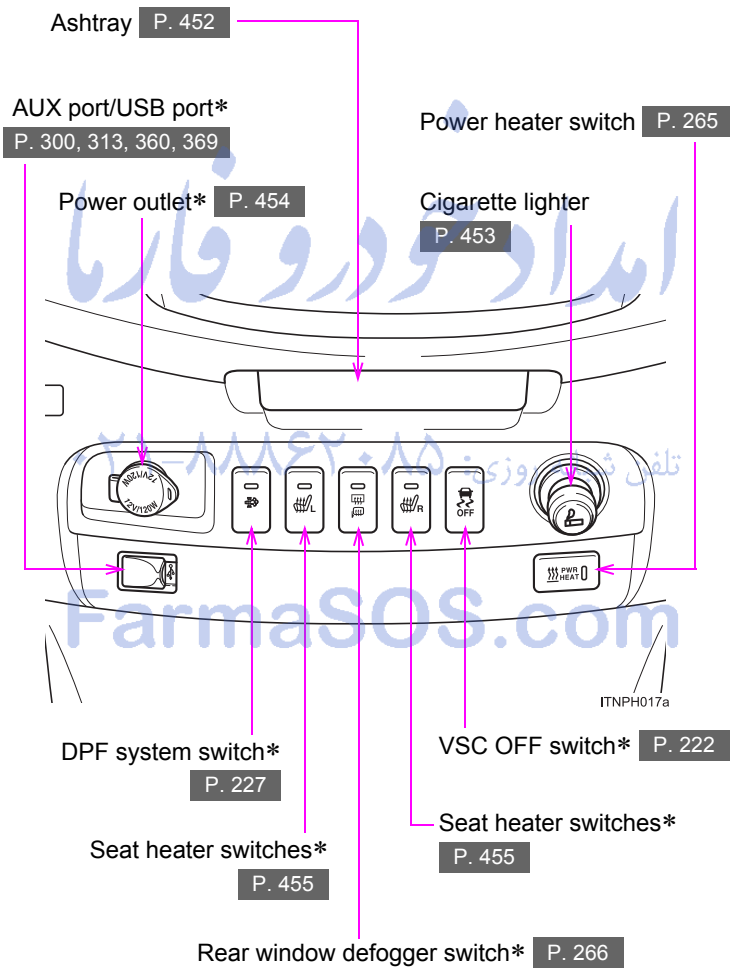

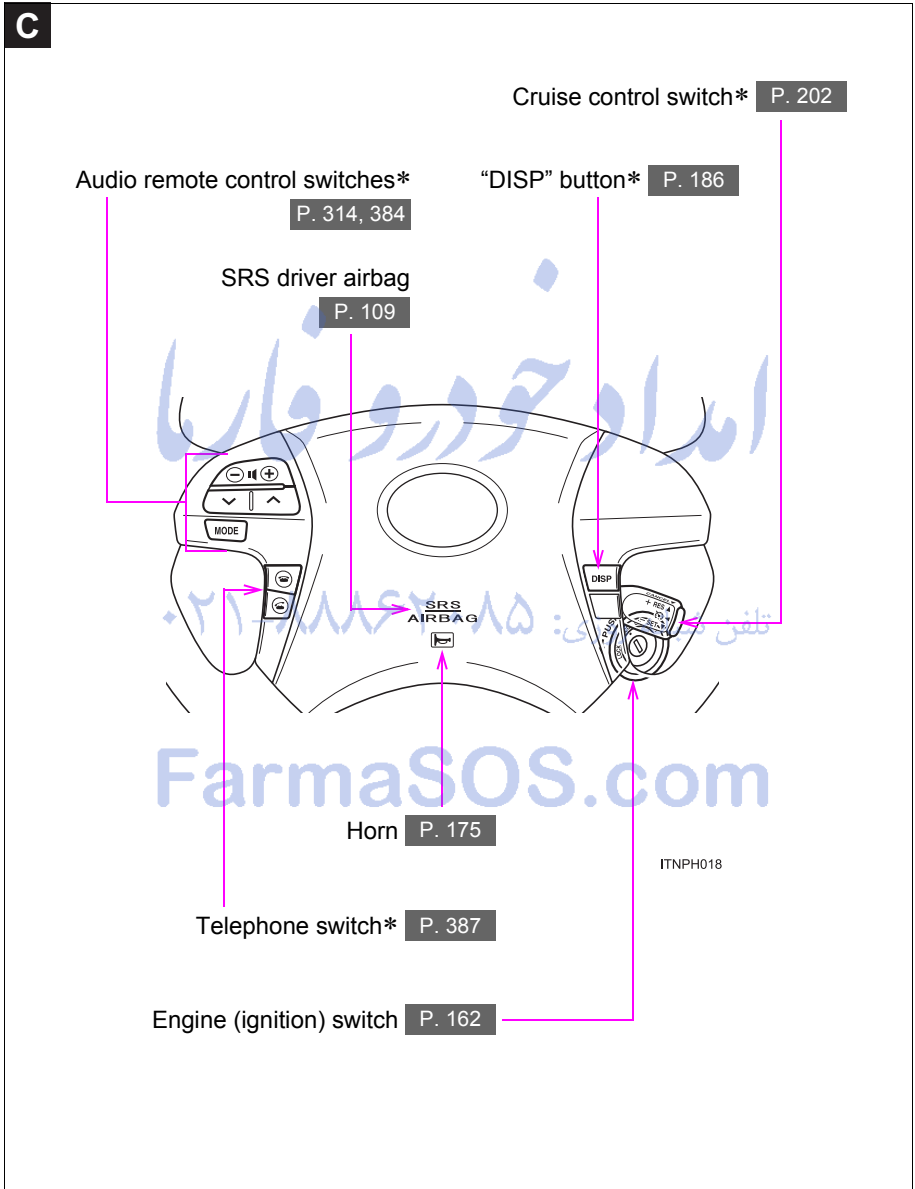

\*: If equipped

**D**

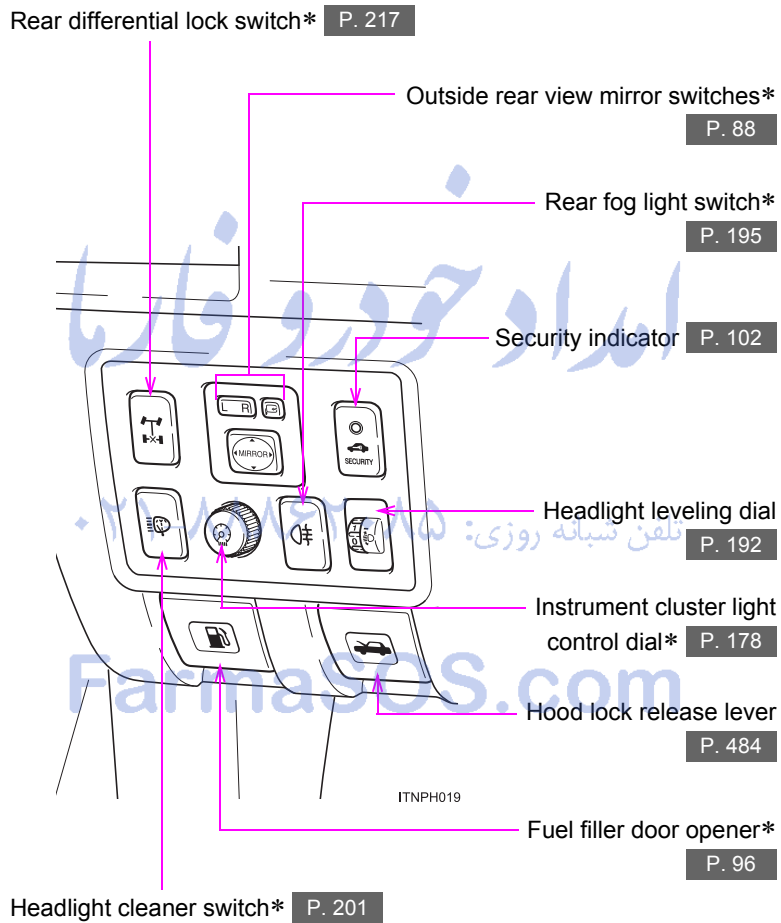



# Pictorial index

## Interior (Right-hand drive vehicles)

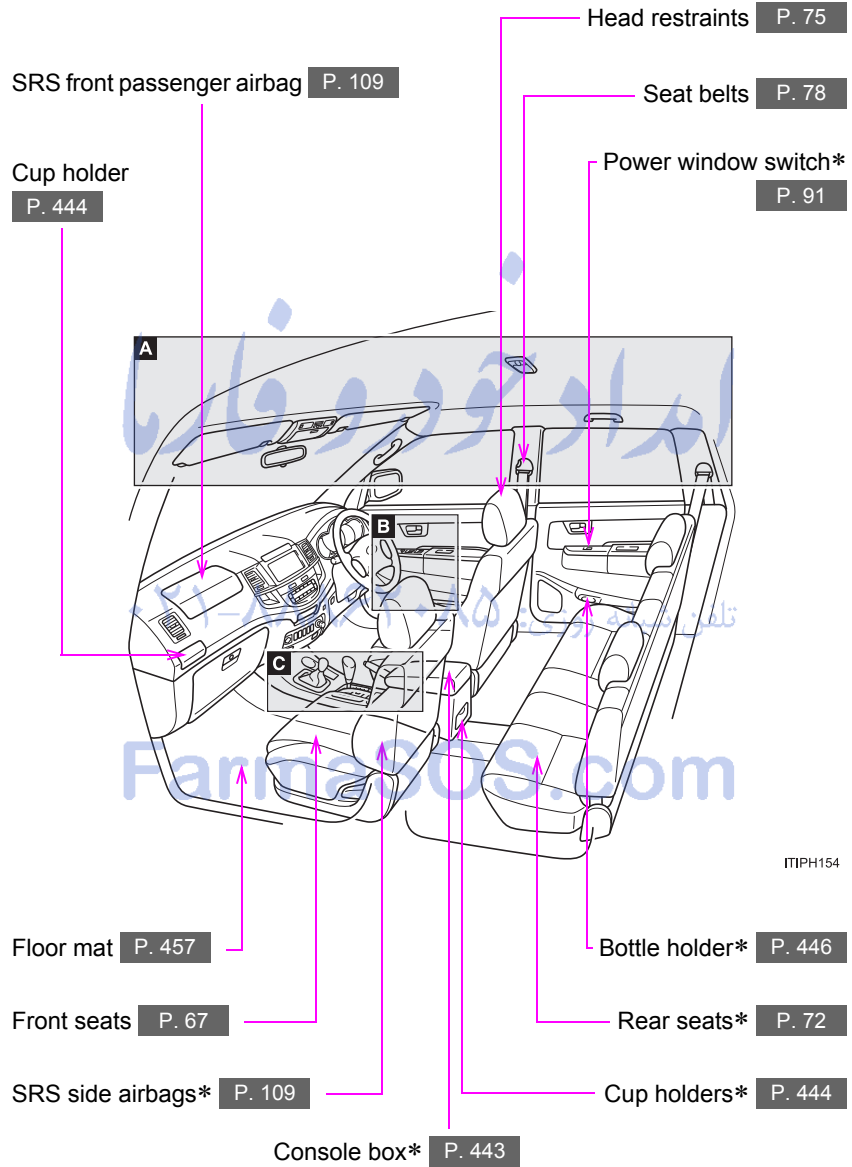

ITPH154

\*: If equipped

**A**

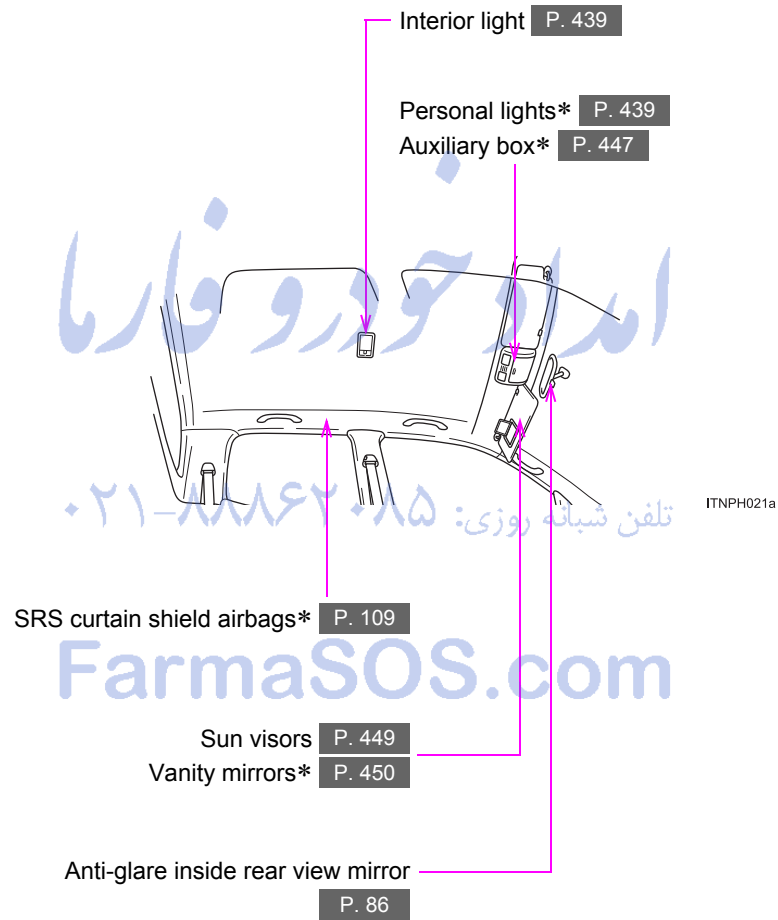

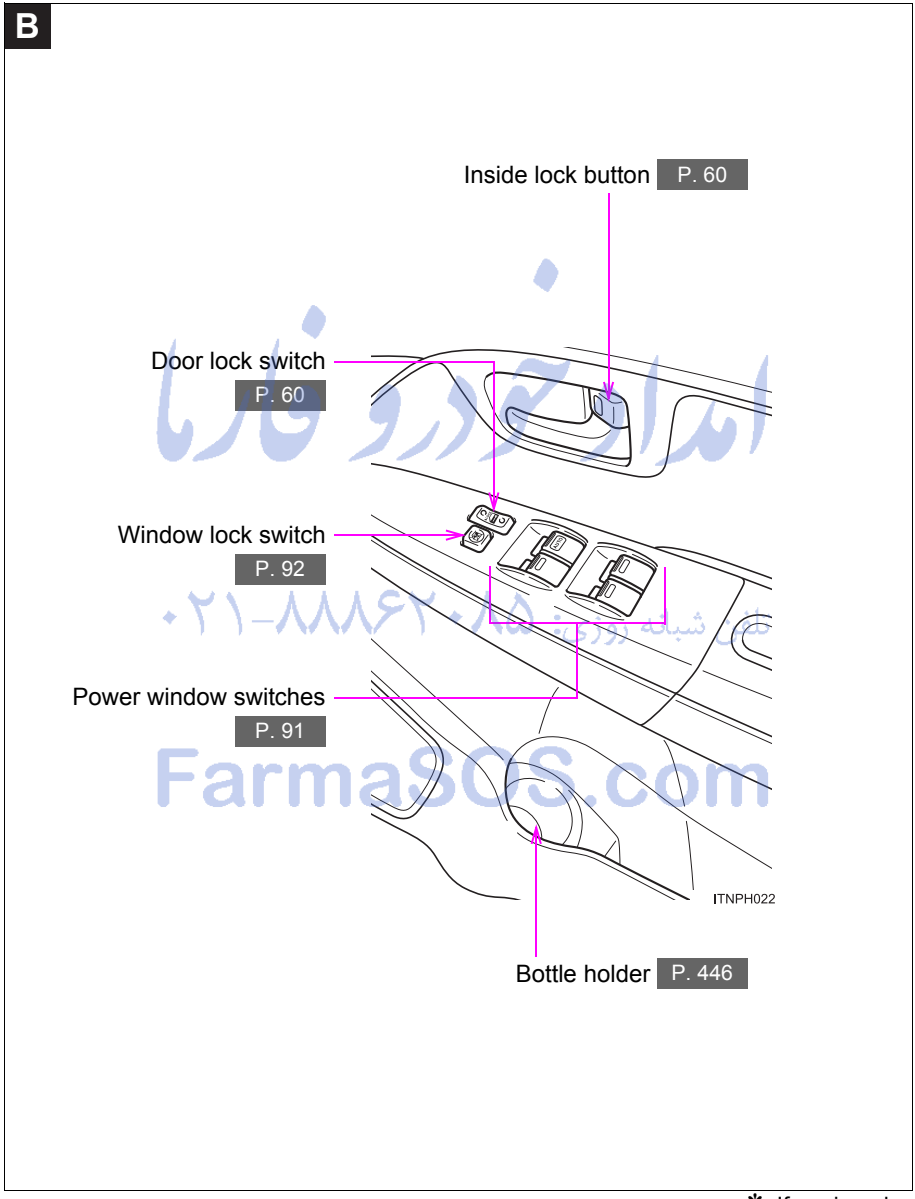

\*: If equipped

**C**

**Vehicles with automatic transmission**

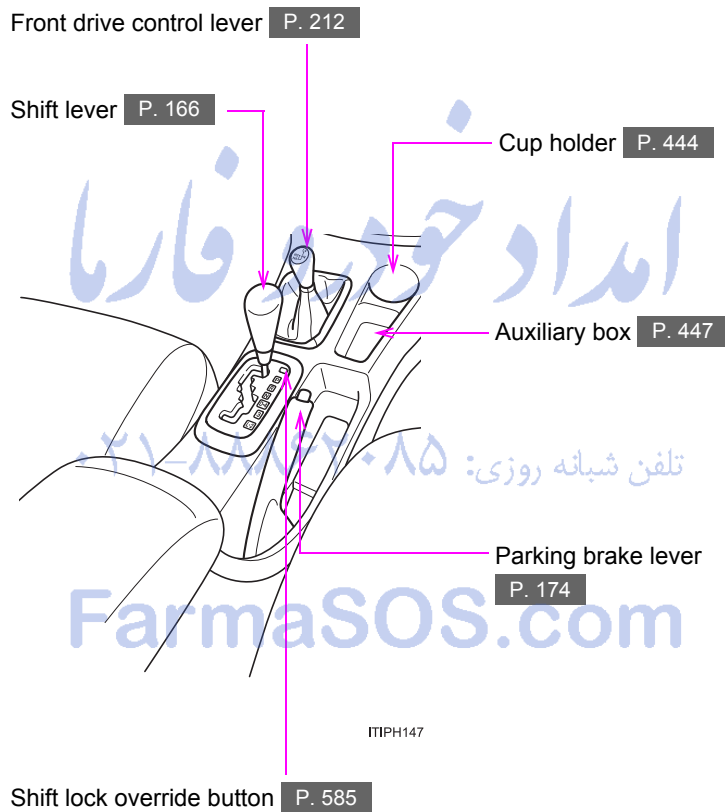

**C**

**Vehicles with manual transmission**

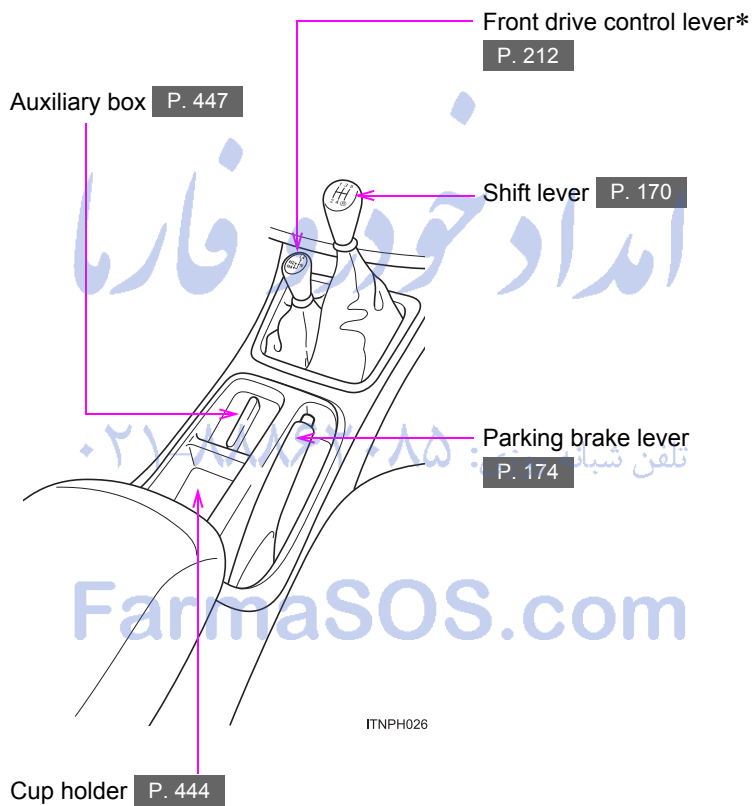

\*: If equipped

## Pictorial index

## Instrument panel (Right-hand drive vehicles)

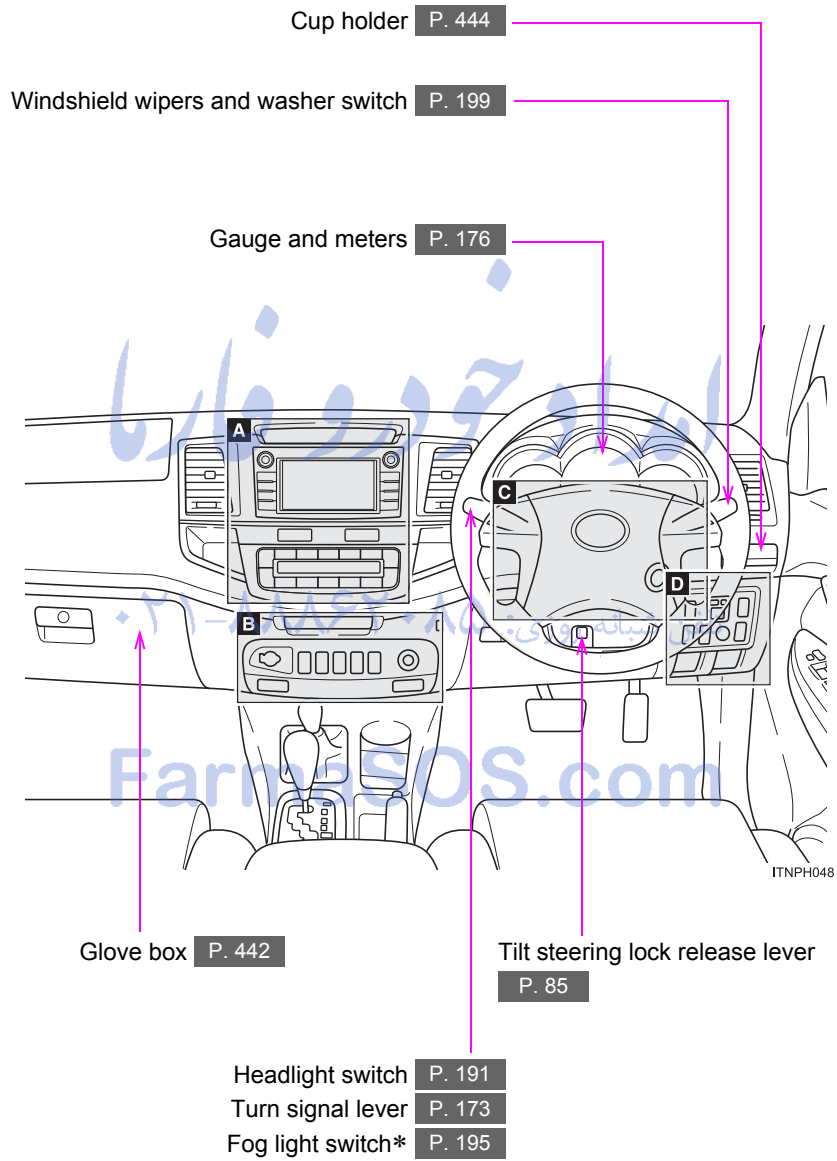

**A**

**Vehicles without automatic air conditioning system**

Audio system\* P. 327      Front passenger's seat belt reminder light P. 561

Rear view monitor system\* P. 207      Multi-information display\* P. 185  
Clock P. 451

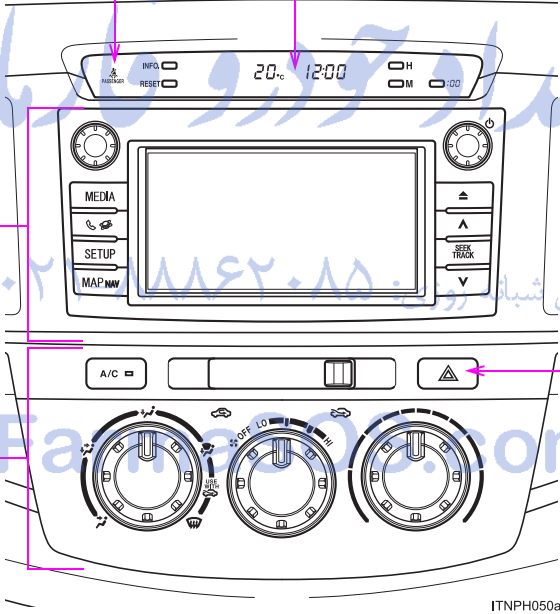

Air conditioning system P. 252      Emergency flasher switch P. 548

\*: If equipped

**A**

**Vehicles with automatic air conditioning system**

Audio system\*

P. 327

Rear view monitor system\* P. 207

Front passenger's seat belt reminder light P. 561

Multi-information display\* P. 185

Clock P. 451

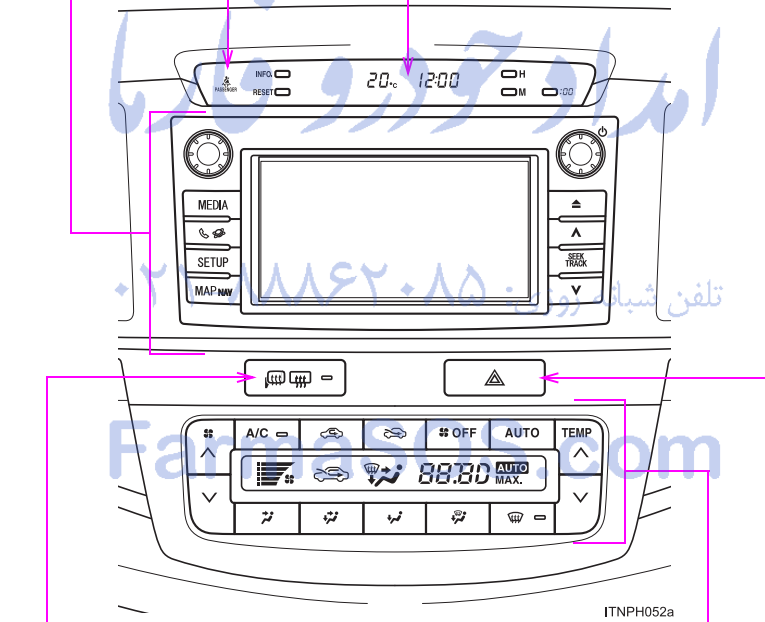

Rear window defogger switch\* P. 266

Air conditioning system P. 258

Emergency flasher switch P. 548

ITNPH052a



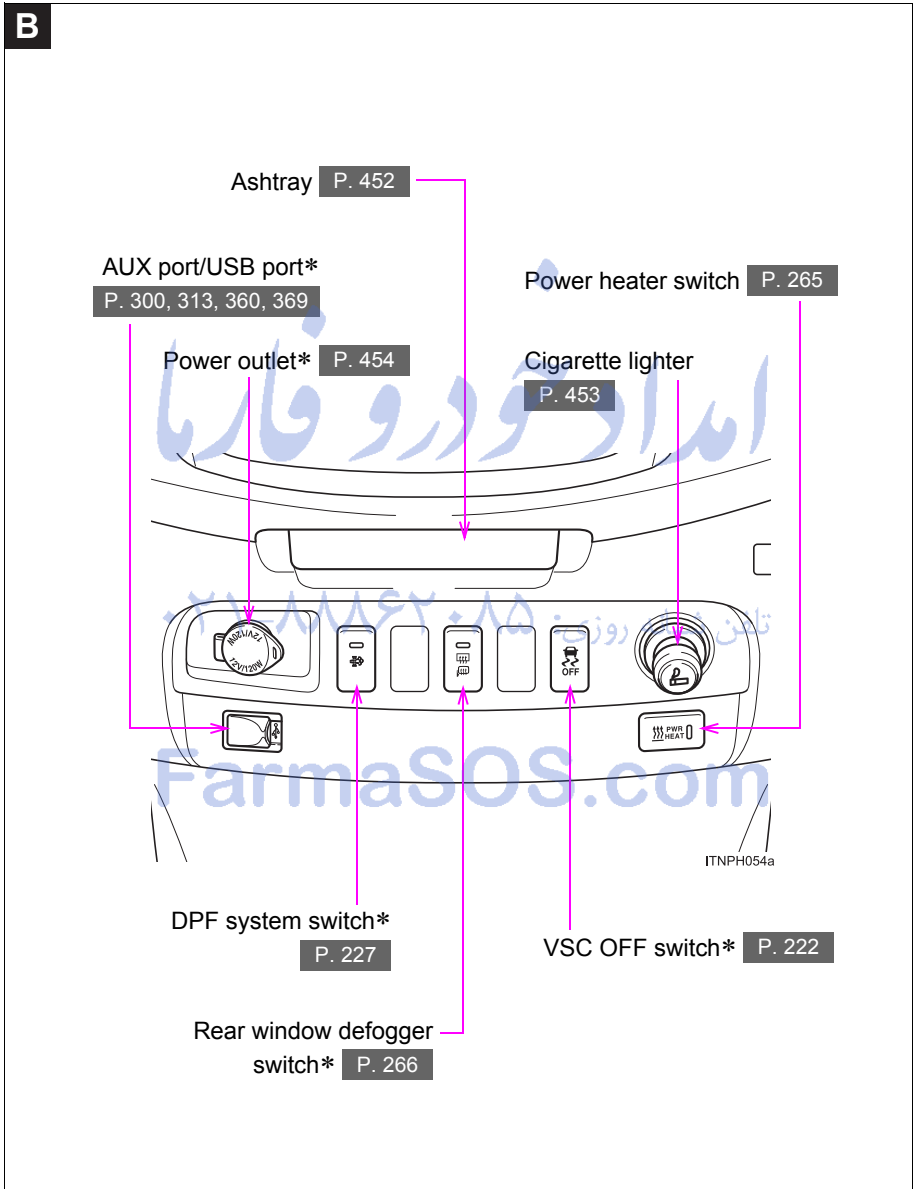

\*: If equipped

**C**

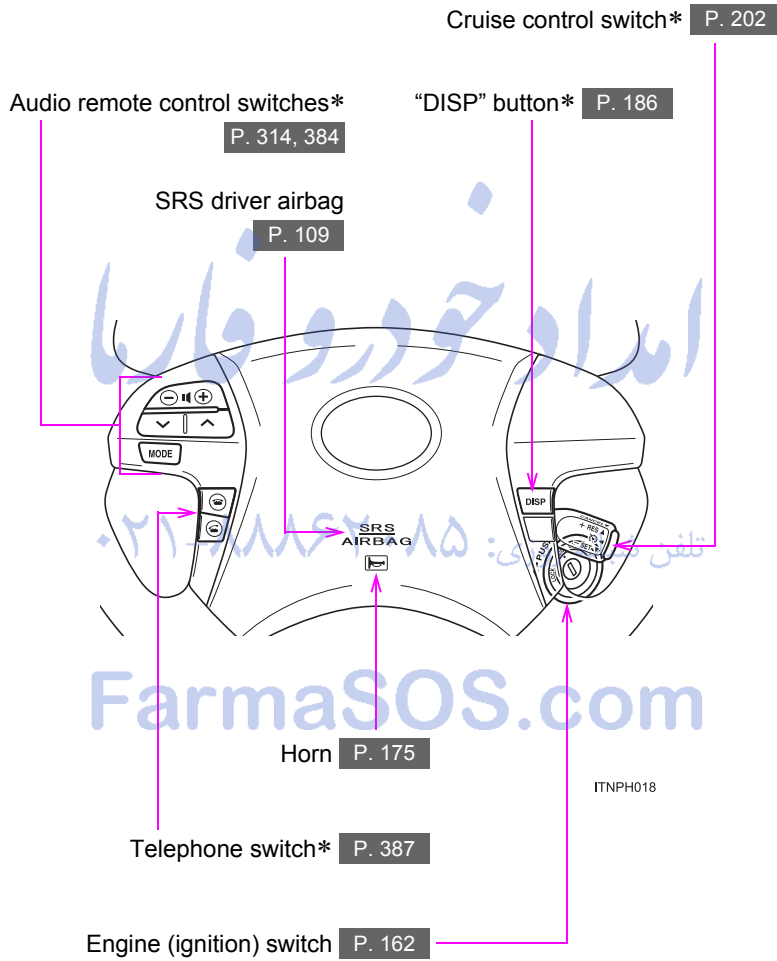

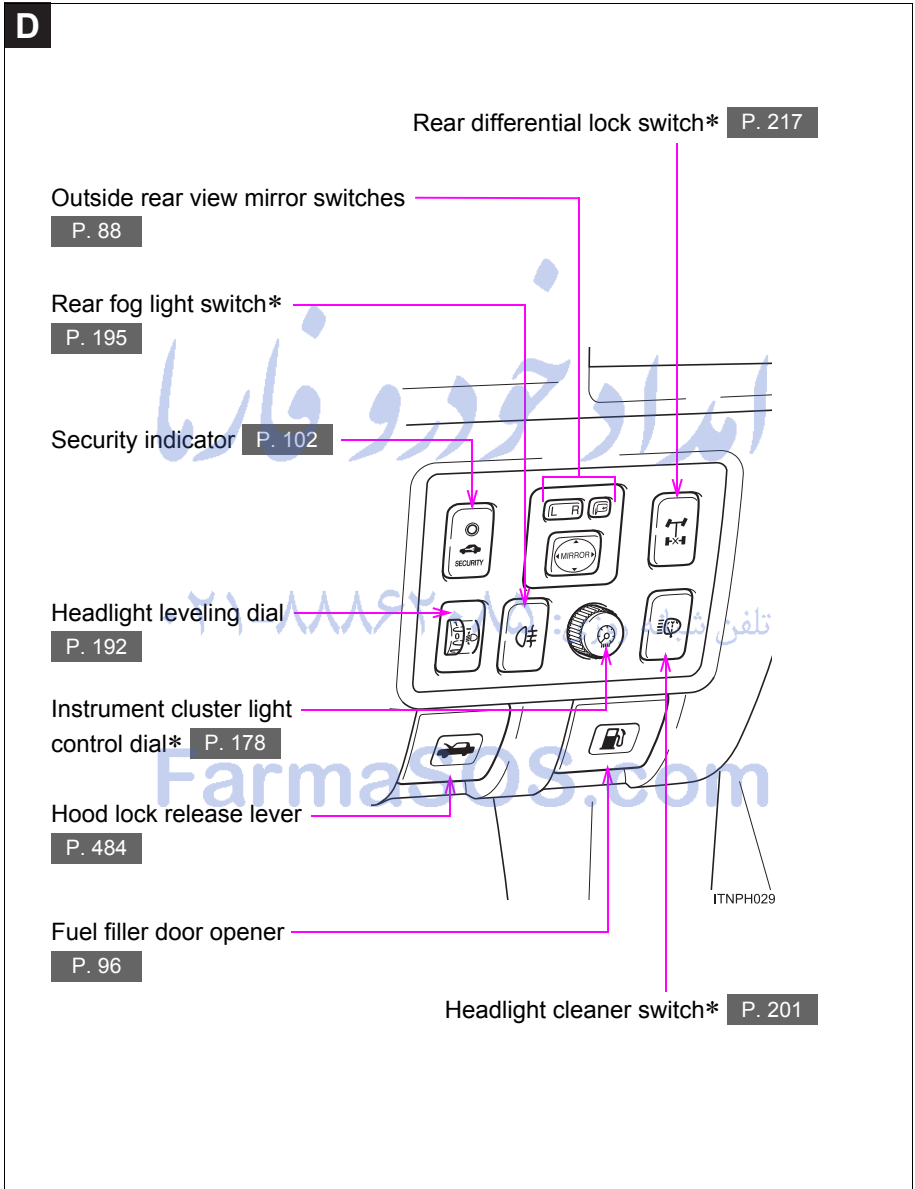

\*: If equipped

## For your information

### **Main Owner's Manual**

Please note that this manual applies to all models and all equipment, including options. Therefore, you may find some explanations for equipment not installed on your vehicle.

All specifications provided in this manual are current at the time of printing. However, because of the Toyota policy of continual product improvement, we reserve the right to make changes at any time without notice.

Depending on specifications, the vehicle shown in the illustrations may differ from your vehicle in terms of equipment.

### **Accessories, spare parts and modification of your Toyota**

Both genuine Toyota and a wide variety of other spare parts and accessories for Toyota vehicles are currently available on the market. Should it be determined that any of the genuine Toyota parts or accessories supplied with the vehicle need to be replaced, Toyota recommends that genuine Toyota parts or accessories, be used to replace them. Other parts or accessories of matching quality can also be used. Toyota cannot accept any liability or guarantee spare parts and accessories which are not genuine Toyota products, nor for replacement or installation involving such parts. In addition, damage or performance problems resulting from the use of non-genuine Toyota spare parts or accessories may not be covered under warranty.

### Installation of an RF-transmitter system

The installation of an RF-transmitter system in your vehicle could affect electronic systems such as:

- Multiport fuel injection system/sequential multi-port fuel injection system
- Cruise control system
- Anti-lock brake system
- SRS airbag system
- Seat belt pretensioner system

Be sure to check with any authorized Toyota dealer or repairer, or another duly qualified and equipped professional for precautionary measures or special instructions regarding installation of an RF-transmitter system.

Further information regarding frequency bands, power levels, antenna positions and installation provisions for the installation of RF-transmitters, is available on request at any authorized Toyota dealer or repairer, or another duly qualified and equipped professional.

تلفن شبانه روزی: ۰۲۱-۸۸۶۲۰۸۵

FarmaSOS.com

## Vehicle data recordings

Your Toyota is equipped with several sophisticated computers that will record certain data, such as:

- Engine speed
- Accelerator status
- Brake status
- Vehicle speed
- Shift position (except manual transmission)

The recorded data varies according to the vehicle grade level and options with which it is equipped. Furthermore, these computers do not record conversations, sounds or pictures.

- Data usage

Toyota may use the data recorded in these computers to diagnose malfunctions, conduct research and development, and improve quality.

Toyota will not disclose the recorded data to a third party except:

- With the consent of the vehicle owner or with the consent of the lessee if the vehicle is leased
- In response to an official request by the police, a court of law or a government agency
- For use by Toyota in a lawsuit
- For research purposes where the data is not tied to a specific vehicle or vehicle owner

## Scrapping of your Toyota

The SRS airbag and seat belt pretensioner devices in your Toyota contain explosive chemicals. If the vehicle is scrapped with the airbags and seat belt pretensioners left as they are, this may cause an accident such as fire. Be sure to have the systems of the SRS airbag and seat belt pretensioner removed and disposed of by a qualified service shop or by any authorized Toyota dealer or repairer, or another duly qualified and equipped professional, before you scrap your vehicle.



Your vehicle contains batteries and/or accumulators. Do not discard them into the environment but cooperate with separate collection (Directive 2006/66/EC).

**⚠ CAUTION**

■ **General precautions while driving**

**Driving under the influence:** Never drive your vehicle when under the influence of alcohol or drugs that have impaired your ability to operate your vehicle. Alcohol and certain drugs delay reaction time, impair judgment and reduce coordination, which could lead to an accident that could result in death or serious injury.

**Defensive driving:** Always drive defensively. Anticipate mistakes that other drivers or pedestrians might make and be ready to avoid accidents.

**Driver distraction:** Always give your full attention to driving. Anything that distracts the driver, such as adjusting controls, talking on a cellular phone or reading can result in a collision with resulting death or serious injury to you, your occupants or others.

 CAUTION

■ **General precaution regarding children's safety**

Never leave children unattended in the vehicle, and never allow children to have or use the key.

Children may be able to start the vehicle or shift the vehicle into neutral. There is also a danger that children may injure themselves by playing with the cigarette lighter, the windows, or other features of the vehicle. In addition, heat build-up or extremely cold temperatures inside the vehicle can be fatal to children.

امداد خودرو فارما

تلفن شبانه روزی: ۰۲۱-۸۸۸۶۲۰۸۵

FarmaSOS.com



## Checking your vehicle's model

Check the model code to see what type of model your vehicle is.

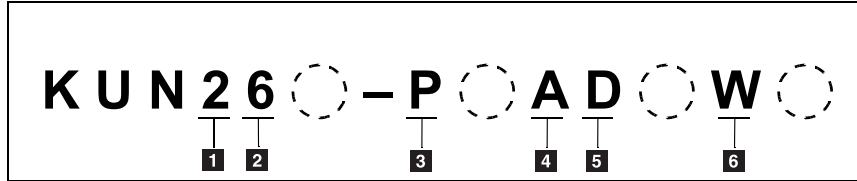

### 1 Driving system

- 2: 4WD models
- 3: Pre Runner

### 2 Basic code

- 6: Models with 1KD-FTV engine
- 5: Models with 2KD-FTV engine

### 3 Cab type and Producing country

- T: Single-cab made in South Africa
- B: Single-cab made in Thailand
- C: Extra-cab made in Thailand
- P: Double-cab made in South Africa
- D: Double-cab made in Thailand

### 4 Transmission type

- A: Automatic transmission
- M: Manual transmission

### 5 Grade

- D: DLX
- S: SR

### 6 Destination

- W: Models for European countries
- H: Models only for Finland

The model code appears on the manufacturer's label with the heading "MODEL".

The label or plate is placed as shown in the following illustrations.

**Type A**

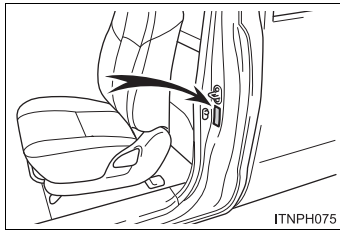

The manufacturer's label is located on the left pillar.

**Type B**

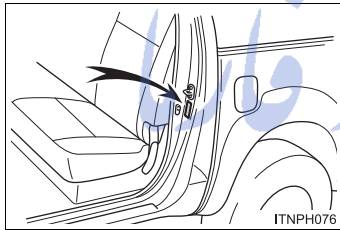

The manufacturer's label is located on the left pillar.

**Type C**

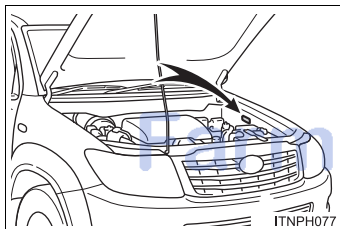

The manufacturer's plate is located beside the engine compartment.

## Symbols used throughout this manual

### Cautions & Notices

#### CAUTION

This is a warning against something which, if ignored, may cause death or serious injury to people. You are informed about what you must or must not do in order to reduce the risk of death or serious injury to yourself and others.

#### NOTICE

This is a warning against something which, if ignored, may cause damage to the vehicle or its equipment. You are informed about what you must or must not do in order to avoid or reduce the risk of damage to your Toyota and its equipment.

### Symbols used in illustrations



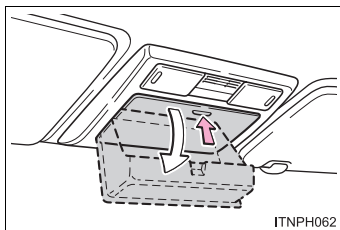

#### Safety symbol

The symbol of a circle with a slash through it means “Do not”, “Do not do this”, or “Do not let this happen”.



#### Arrows indicating operations

 Indicates the action (pushing, turning, etc.) used to operate switches and other devices.

 Indicates the outcome of an operation (e.g. a lid opens).

# امداد خودرو فارما

تلفن شبانه روزی: ۰۲۱-۸۸۸۶۲۰۸۵

**FarmaSOS.com**

## Before driving

# 1

<b>1-1. Key information</b>		<b>1-4. Opening and closing the windows</b>	
Keys.....	46	Power windows.....	91
<b>1-2. Opening, closing and locking the doors</b>		Quarter windows (extra-cab models).....	94
Wireless remote control.....	48	Back window (vehicles with sliding type).....	95
Side doors.....	59	<b>1-5. Refueling</b>	
Tailgate.....	63	Opening the fuel tank cap.....	96
<b>1-3. Adjustable components (seats, mirrors, steering wheel)</b>		<b>1-6. Theft deterrent system</b>	
Front seats.....	67	Engine immobilizer system.....	102
Rear seats.....	72	<b>1-7. Safety information</b>	
Head restraints.....	75	Correct driving posture.....	107
Seat belts.....	78	SRS airbags.....	109
Steering wheel.....	85	Child restraint systems.....	122
Inside rear view mirror.....	86	Installing child restraints ...	134
Outside rear view mirrors.....	88		

## 1-1. Key information

### Keys

The following keys are provided with the vehicle.

#### Type A

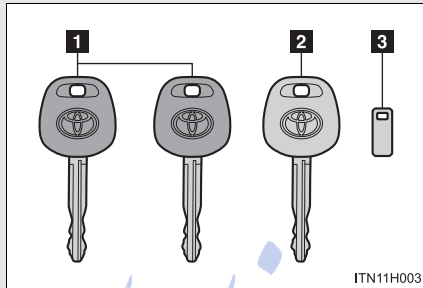

- 1 Master keys
- 2 Valet key
- 3 Key number plate

#### Type B

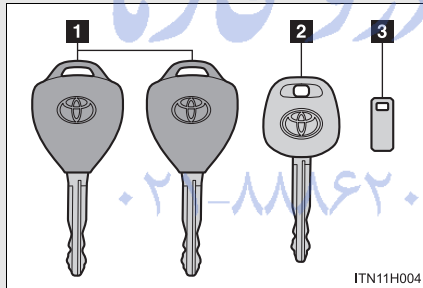

- 1 Master keys (with wireless remote control function)  
Operating the wireless remote control function (→P. 48)
- 2 Valet key
- 3 Key number plate

FarmaSOS.com

■ **When required to leave the vehicle's key with a parking attendant**

Lock the glove box as circumstances demand. (→P. 442)

Carry the master key for your own use and provide the attendant with the valet key.

■ **Key number plate**

Keep the plate in a safe place such as your wallet, not in the vehicle. In the event that a key is lost, a new key can be made by any authorized Toyota dealer or repairer, or another duly qualified and equipped professional, using the key number plate. (→P. 586)

■ **When riding in an aircraft (type B)**

When bringing a key with wireless remote control function onto an aircraft, make sure you do not press any buttons on the key while inside the aircraft cabin. If you are carrying the key in your bag etc., ensure that the buttons are not likely to be pressed accidentally. Pressing a button may cause the key to emit radio waves that could interfere with the operation of the aircraft.

 **NOTICE**

■ **To prevent key damage**

Observe the following:

- Do not subject the keys to strong shocks, expose them to high temperatures by placing them in direct sunlight, or get them wet.
- Do not expose the keys to electromagnetic materials or attach any material that blocks electromagnetic waves to the key surface.
- Do not disassemble the keys.

## 1-2. Opening, closing and locking the doors Wireless remote control\*

The wireless remote control can be used to lock and unlock the vehicle.

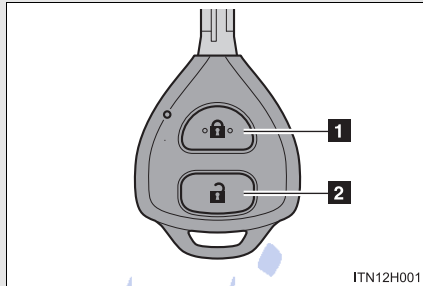

- 1** Locks all the doors
- 2** Unlocks all the doors

امداد خودرو فارما

تلفن شبانه روزی: ۰۲۱-۸۸۸۶۲۰۸۵

FarmaSOS.com

\*: If equipped



---

■ **Operation signals**

The emergency flashers flash to indicate that the doors have been locked/unlocked. (Locked: once; Unlocked: twice)

■ **Security feature**

If a door is not opened within approximately 30 seconds after the vehicle is unlocked, the security feature automatically locks the vehicle again.

■ **Conditions affecting operation**

The wireless remote control function may not operate normally in the following situations:

- Near a TV tower, radio station, electric power plant, airport or other facility that generates strong radio waves
- When carrying a portable radio, cellular phone or other wireless communication devices
- When multiple wireless keys are in the vicinity
- When the wireless key is in contact with, or is covered by a metallic object
- When a wireless key (that emits radio waves) is being used nearby
- When the wireless key has been left near an electrical appliance such as a personal computer

■ **Key battery depletion**

If the wireless remote control function does not operate, the battery may be depleted. Replace the battery when necessary. (→P. 513)

## 1-2. Opening, closing and locking the doors

### ■ Certification for wireless remote control

Hereby, Tokai Rika Co., Ltd., declares that this B41TA is in compliance with the essential requirements and other relevant provisions of Directive 1999/5/EC.

**TOKAI RIKA**

### R&TTE Declaration of Conformity

We,

Manufacturer's Name: Tokai Rika Co., Ltd.  
Manufacturer's Address: 260, Toyota 3-chome, Oguchi-cho, Niwa-gun, Aichi-ken,  
480-0195, Japan

hereby declare under our sole responsibility that the product:

Product Name: RKE Transmitter  
Product Model: B41TA

to which this declaration relates is in conformity with the essential requirements and other relevant requirements of the R&TTE Directive (1999/5/EC). The product is compliant with the following standards and/or other normative documents:

Safety: EN60950-1  
EMC: EN301 489-1 & -3  
Spectrum: EN300 220-3

Supplementary information:

* Technical File kept by	TRB Limited 1 TRB Drive, St. Asaph Business Park, St. Asaph, Denbighshire, LL17 OJB, The United Kingdom
* CE mark	
* Member states intended for use	EU and EFTA
* Member states with restrictive use	None

Date: April 21, 2004

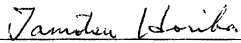
Signature:   
Tamotsu Horiba

Position of the signatory: General Manager,  
Electronics Engineering Div.

## 1-2. Opening, closing and locking the doors

Hereby, Tokai Rika Co., Ltd., declares that this B41TA is in compliance with the essential requirements and other relevant provisions of Directive 1999/5/EC.
Tokai Rika Co., Ltd. vakuuttaa täten että B41TA tyyppinen laite on direktiivin 1999/5/EY oleellisten vaatimusten ja sitä koskevien direktiivin muiden ehtojen mukainen.
Hierbij verklaart Tokai Rika Co., Ltd. dat het toestel B41TA in overeenstemming is met de essentiële eisen en de andere relevante bepalingen van richtlijn 1999/5/EG.
Par la présente Tokai Rika Co., Ltd. déclare que l'appareil B41TA est conforme aux exigences essentielles et aux autres dispositions pertinentes de la directive 1999/5/CE.
Härmed intygar Tokai Rika Co., Ltd. att denna B41TA står i överensstämmelse med de väsentliga egenskapskrav och övriga relevanta bestämmelser som framgår av direktiv 1999/5/EG.
Undertegnede Tokai Rika Co., Ltd. erklærer herved, at følgende udstyr B41TA overholder de væsentlige krav og øvrige relevante krav i direktiv 1999/5/EF.
Hiermit erklärt Tokai Rika Co., Ltd., dass sich das Gerät B41TA in Übereinstimmung mit den grundlegenden Anforderungen und den übrigen einschlägigen Bestimmungen der Richtlinie 1999/5/EG befindet.
ΜΕ ΤΗΝ ΠΑΡΟΥΣΑ Tokai Rika Co., Ltd. ΔΗΛΩΝΕΙ ΟΤΙ Β41ΤΑ ΣΥΜΜΟΡΦΩΝΕΤΑΙ ΠΡΟΣ ΤΙΣ ΟΥΣΙΩΔΕΙΣ ΑΠΑΙΤΗΣΕΙΣ ΚΑΙ ΤΙΣ ΛΟΙΠΕΣ ΣΧΕΤΙΚΕΣ ΔΙΑΤΑΞΕΙΣ ΤΗΣ ΟΔΗΓΙΑΣ 1999/5/ΕΚ.
Con la presente Tokai Rika Co., Ltd. dichiara che questo B41TA è conforme ai requisiti essenziali ed alle altre disposizioni pertinenti stabilite dalla direttiva 1999/5/CE.
Por medio de la presente Tokai Rika Co., Ltd. declara que el B41TA cumple con los requisitos esenciales y cualesquiera otras disposiciones aplicables o exigibles de la Directiva 1999/5/CE.
Tokai Rika Co., Ltd. declara que este B41TA está conforme com os requisitos essenciais e outras disposições da Directiva 1999/5/CE.
Hawnhekk, Tokai Rika Co., Ltd., jiddikjara li dan B41TA jikkonforma mal-htigijiet essenzjali u ma provvedimenti oħrajn relevanti li hemm fid-Dirrettiva 1999/5/EC.

1

Before driving

## 1-2. Opening, closing and locking the doors

Käesolevaga kinnitab Tokai Rika Co., Ltd. seadme B41TA vastavust direktiivi 1999/5/EÜ põhinõuetele ja nimetatud direktiivist tulenevatele teistele asjakohastele sätetele.
Alulírott, Tokai Rika Co., Ltd. nyilatkozom, hogy a B41TA megfelel a vonatkozó alapvető követelményeknek és az 1999/5/EC irányelv egyéb előírásainak.
Tokai Rika Co., Ltd. týmto vyhlasuje, že B41TA spĺňa základné požiadavky a všetky príslušné ustanovenia Smernice 1999/5/ES.
Tokai Rika Co., Ltd. tímto prohlašuje, že tento B41TA je ve shodě se základními požadavky a dalšími příslušnými ustanoveními směrnice 1999/5/ES.
Tokai Rika Co., Ltd. izjavlja, da je ta B41TA v skladu z bistvenimi zahtevami in ostalimi relevantnimi določili direktive 1999/5/ES.
Šiuo Tokai Rika Co., Ltd. deklaruoja, kad šis B41TA atitinka esminius reikalavimus ir kitas 1999/5/EB Direktyvos nuostatas.
Ar šo Tokai Rika Co., Ltd. deklarē, ka B41TA atbilst Direktīvas 1999/5/EK būtiskajām prasībām un citiem ar to saistītajiem noteikumiem.
Niniejszym Tokai Rika Co., Ltd. oświadcza, że B41TA jest zgodny z zasadniczymi wymogami oraz pozostałymi stosownymi postanowieniami Dyrektywy 1999/5/EC.
Hér með lýsir Tokai Rika Co., Ltd. yfir því að B41TA er í samræmi við grunnkröfur og aðrar kröfur, sem gerðar eru í tilskipun 1999/5/EC.
Tokai Rika Co., Ltd. erklærer herved at utsyret B41TA er i samsvar med de grunnleggende krav og øvrige relevante krav i direktiv 1999/5/EF.
С настоящето, Tokai Rika Co., Ltd., декларира, че B41TA е в съответствие със съществените изисквания и другите приложими разпоредби на Директива 1999/5/EC.
Prin prezenta, Tokai Rika Co., Ltd., declară că aparatul B41TA este în conformitate cu cerințele esențiale și cu alte prevederi pertinente ale Directivei 1999/5/CE.
Ovim, Tokai Rika Co., Ltd., izjavljuje da ovaj B41TA je usklađen sa bitnim zahtjevima i drugim relevantnim odredbama Direktive 1999/5/EC.

Hereby, Tokai Rika Co., Ltd., declares that this B42TA is in compliance with the essential requirements and other relevant provisions of Directive 1999/5/EC.

**TOKAI RIKA**

1

Before driving

### R&TTE Declaration of Conformity

We,

Manufacturer's Name: Tokai Rika Co., Ltd.  
 Manufacturer's Address: 260, Toyota 3-chome, Oguchi-cho, Niwa-gun, Aichi-ken,  
 480-0195, Japan

hereby declare under our sole responsibility that the product:

Product Name: RKE Transmitter  
 Product Model: B42TA

to which this declaration relates is in conformity with the essential requirements and other relevant requirements of the R&TTE Directive (1999/5/EC). The product is compliant with the following standards and/or other normative documents:

Safety: EN60950-1  
 EMC: EN301 489-1 & -3  
 Spectrum: EN300 220-3

Supplementary information:

* Technical File kept by	TRB Limited 1 TRB Drive, St. Asaph Business Park, St. Asaph, Denbighshire, LL17 0JB, The United Kingdom
* CE mark	
* Member states intended for use	EU and EFTA
* Member states with restrictive use	None

**Date:** February 17, 2004

**Signature:** Tamotsu Horiba

**Position of the signatory:** General Manager,  
 Electronics Engineering Div.

## 1-2. Opening, closing and locking the doors

Hereby, Tokai Rika Co., Ltd., declares that this B42TA is in compliance with the essential requirements and other relevant provisions of Directive 1999/5/EC.
Tokai Rika Co., Ltd. vakuuttaa täten että B42TA tyyppinen laite on direktiivin 1999/5/EY oleellisten vaatimusten ja sitä koskevien direktiivin muiden ehtojen mukainen.
Hierbij verklaart Tokai Rika Co., Ltd. dat het toestel B42TA in overeenstemming is met de essentiële eisen en de andere relevante bepalingen van richtlijn 1999/5/EG.
Par la présente Tokai Rika Co., Ltd. déclare que l'appareil B42TA est conforme aux exigences essentielles et aux autres dispositions pertinentes de la directive 1999/5/CE.
Härmed intygar Tokai Rika Co., Ltd. att denna B42TA står i överensstämmelse med de väsentliga egenskapskrav och övriga relevanta bestämmelser som framgår av direktiv 1999/5/EG.
Undertegnede Tokai Rika Co., Ltd. erklærer herved, at følgende udstyr B42TA overholder de væsentlige krav og øvrige relevante krav i direktiv 1999/5/EF.
Hiermit erklärt Tokai Rika Co., Ltd., dass sich das Gerät B42TA in Übereinstimmung mit den grundlegenden Anforderungen und den übrigen einschlägigen Bestimmungen der Richtlinie 1999/5/EG befindet.
ΜΕ ΤΗΝ ΠΑΡΟΥΣΑ Tokai Rika Co., Ltd. ΔΗΛΩΝΕΙ ΟΤΙ Β42ΤΑ ΣΥΜΜΟΡΦΩΝΕΤΑΙ ΠΡΟΣ ΤΙΣ ΟΥΣΙΩΔΕΙΣ ΑΠΑΙΤΗΣΕΙΣ ΚΑΙ ΤΙΣ ΛΟΙΠΕΣ ΣΧΕΤΙΚΕΣ ΔΙΑΤΑΞΕΙΣ ΤΗΣ ΟΔΗΓΙΑΣ 1999/5/ΕΚ.
Con la presente Tokai Rika Co., Ltd. dichiara che questo B42TA è conforme ai requisiti essenziali ed alle altre disposizioni pertinenti stabilite dalla direttiva 1999/5/CE.
Por medio de la presente Tokai Rika Co., Ltd. declara que el B42TA cumple con los requisitos esenciales y cualesquiera otras disposiciones aplicables o exigibles de la Directiva 1999/5/CE.
Tokai Rika Co., Ltd. declara que este B42TA está conforme com os requisitos essenciais e outras disposições da Directiva 1999/5/CE.
Hawnhekk, Tokai Rika Co., Ltd., jiddikjara li dan B42TA jikkonforma mal-htigijiet essenzjali u ma provvedimenti oħrajn relevanti li hemm fid-Dirrettiva 1999/5/EC.

## 1-2. Opening, closing and locking the doors

Käesolevaga kinnitab Tokai Rika Co., Ltd. seadme B42TA vastavust direktiivi 1999/5/EÜ põhinõuetele ja nimetatud direktiivist tulenevatele teistele asjakohastele sätetele.
Alulírott, Tokai Rika Co., Ltd. nyilatkozom, hogy a B42TA megfelel a vonatkozó alapvető követelményeknek és az 1999/5/EC irányelv egyéb előírásainak.
Tokai Rika Co., Ltd. týmto vyhlasuje, že B42TA splňa základné požiadavky a všetky príslušné ustanovenia Smernice 1999/5/ES.
Tokai Rika Co., Ltd. tímto prohlašuje, že tento B42TA je ve shodě se základními požadavky a dalšími příslušnými ustanoveními směrnice 1999/5/ES.
Tokai Rika Co., Ltd. izjavlja, da je ta B42TA v skladu z bistvenimi zahtevami in ostalimi relevantnimi določili direktive 1999/5/ES.
Šiuo Tokai Rika Co., Ltd. deklaruoja, kad šis B42TA atitinka esminius reikalavimus ir kitas 1999/5/EB Direktyvos nuostatas.
Ar šo Tokai Rika Co., Ltd. deklarē, ka B42TA atbilst Direktīvas 1999/5/EK būtiskajām prasībām un citiem ar to saistītajiem noteikumiem.
Niniejszym Tokai Rika Co., Ltd. oświadcza, że B42TA jest zgodny z zasadniczymi wymogami oraz pozostałymi stosownymi postanowieniami Dyrektywy 1999/5/EC.
Hér með lýsir Tokai Rika Co., Ltd. yfir því að B42TA er í samræmi við grunnkröfur og aðrar kröfur, sem gerðar eru í tilskipun 1999/5/EC.
Tokai Rika Co., Ltd. erklærer herved at utsyret B42TA er i samsvar med de grunnleggende krav og øvrige relevante krav i direktiv 1999/5/EF.
С настоящето, Tokai Rika Co., Ltd., декларира, че B42TA е в съответствие със съществените изисквания и другите приложими разпоредби на Директива 1999/5/EC.
Prin prezenta, Tokai Rika Co., Ltd., declară că aparatul B42TA este în conformitate cu cerințele esențiale și cu alte prevederi pertinente ale Directivei 1999/5/CE.
Ovim, Tokai Rika Co., Ltd., izjavljuje da ovaj B42TA je usklađen sa bitnim zahtjevima i drugim relevantnim odredbama Direktive 1999/5/EC.

1

Before driving

1-2. Opening, closing and locking the doors

Hereby, Tokai Rika Co., Ltd., declares that this B25RA is in compliance with the essential requirements and other relevant provisions of Directive 1999/5/EC.

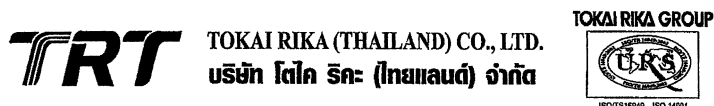

### R&TTE Declaration of Conformity

We,

Manufacturer's Name: TOKAI RIKA (THAILAND) CO., LTD.  
Manufacturer's Address: Amata City Industrial Estate 7/ 114 M.4 T. Mabyangporn A.  
Pluakdeang Rayoung 21140, Thailand

hereby declare under our sole responsibility that the product:

Product Name: Receiver  
Product Model: B25RA

to which this declaration relates is in conformity with the essential requirements and other relevant requirements of the R&TTE Directive (1999/5/EC). The product is compliant with the following standards and/or other normative documents:

Safety: EN60950-1  
EMC: EN301 489-1 & -3  
Spectrum: EN300 220-2

Supplementary information:

* CE mark	
* Member states intended for use	EU and EFTA
* Member states with restrictive use	None

Date:

7 November 2007

Signature:

Position of the signatory:

Toshihiro Matsui  
Vice President



## 1-2. Opening, closing and locking the doors

<p>Hereby, Tokai Rika Co., Ltd., declares that this B25RA is in compliance with the essential requirements and other relevant provisions of Directive 1999/5/EC.</p>
<p>Tokai Rika Co., Ltd. vakuuttaa täten että B25RA tyyppinen laite on direktiivin 1999/5/EY oleellisten vaatimusten ja sitä koskevien direktiivin muiden ehtojen mukainen.</p>
<p>Hierbij verklaart Tokai Rika Co., Ltd. dat het toestel B25RA in overeenstemming is met de essentiële eisen en de andere relevante bepalingen van richtlijn 1999/5/EG.</p>
<p>Par la présente Tokai Rika Co., Ltd. déclare que l'appareil B25RA est conforme aux exigences essentielles et aux autres dispositions pertinentes de la directive 1999/5/CE.</p>
<p>Härmed intygar Tokai Rika Co., Ltd. att denna B25RA står i överensstämmelse med de väsentliga egenskapskrav och övriga relevanta bestämmelser som framgår av direktiv 1999/5/EG.</p>
<p>Undertegnede Tokai Rika Co., Ltd. erklærer herved, at følgende udstyr B25RA overholder de væsentlige krav og øvrige relevante krav i direktiv 1999/5/EF.</p>
<p>Hiermit erklärt Tokai Rika Co., Ltd., dass sich das Gerät B25RA in Übereinstimmung mit den grundlegenden Anforderungen und den übrigen einschlägigen Bestimmungen der Richtlinie 1999/5/EG befindet.</p>
<p>ΜΕ ΤΗΝ ΠΑΡΟΥΣΑ Tokai Rika Co., Ltd. ΔΗΛΩΝΕΙ ΟΤΙ Β25RA ΣΥΜΜΟΡΦΟΝΕΤΑΙ ΠΡΟΣ ΤΙΣ ΟΥΣΙΩΔΕΙΣ ΑΠΑΙΤΗΣΕΙΣ ΚΑΙ ΤΙΣ ΛΟΙΠΕΣ ΣΧΕΤΙΚΕΣ ΔΙΑΤΑΞΕΙΣ ΤΗΣ ΟΔΗΓΙΑΣ 1999/5/ΕΚ.</p>
<p>Con la presente Tokai Rika Co., Ltd. dichiara che questo B25RA è conforme ai requisiti essenziali ed alle altre disposizioni pertinenti stabilite dalla direttiva 1999/5/CE.</p>
<p>Por medio de la presente Tokai Rika Co., Ltd. declara que el B25RA cumple con los requisitos esenciales y cualesquiera otras disposiciones aplicables o exigibles de la Directiva 1999/5/CE.</p>
<p>Tokai Rika Co., Ltd. declara que este B25RA está conforme com os requisitos essenciais e outras disposições da Directiva 1999/5/CE.</p>
<p>Hawnhekk, Tokai Rika Co., Ltd., jiddikjara li dan B25RA jikkonforma mal-htigijiet essenzjali u ma provvedimenti oħrajn rilevanti li hemm fid-Dirrettiva 1999/5/EC.</p>

1

Before driving

## 1-2. Opening, closing and locking the doors

<p>Käesolevaga kinnitab Tokai Rika Co., Ltd. seadme B25RA vastavust direktiivi 1999/5/EÜ põhinõuetele ja nimetatud direktiivist tulenevatele teistele asjakohastele sätetele.</p>
<p>Alulírott, Tokai Rika Co., Ltd. nyilatkozom, hogy a B25RA megfelel a vonatkozó alapvető követelményeknek és az 1999/5/EC irányelv egyéb előírásainak.</p>
<p>Tokai Rika Co., Ltd. týmto vyhlasuje, že B25RA splňa základné požiadavky a všetky príslušné ustanovenia Smernice 1999/5/ES.</p>
<p>Tokai Rika Co., Ltd. tímto prohlašuje, že tento B25RA je ve shodě se základními požadavky a dalšími příslušnými ustanoveními směrnice 1999/5/ES.</p>
<p>Tokai Rika Co., Ltd. izjavlja, da je ta B25RA v skladu z bistvenimi zahtevami in ostalimi relevantnimi določili direktive 1999/5/ES.</p>
<p>Šiuo Tokai Rika Co., Ltd. deklaruoja, kad šis B25RA atitinka esminius reikalavimus ir kitas 1999/5/EB Direktyvos nuostatas.</p>
<p>Ar šo Tokai Rika Co., Ltd. deklarē, ka B25RA atbilst Direktīvas 1999/5/EK būtiskajām prasībām un citiem ar to saistītajiem noteikumiem.</p>
<p>Niniejszym Tokai Rika Co., Ltd. oświadcza, że B25RA jest zgodny z zasadniczymi wymogami oraz pozostałymi stosownymi postanowieniami Dyrektywy 1999/5/EC.</p>
<p>Hér með lýsir Tokai Rika Co., Ltd. yfir því að B25RA er í samræmi við grunnkröfur og aðrar kröfur, sem gerðar eru í tilskipun 1999/5/EC.</p>
<p>Tokai Rika Co., Ltd. erklærer herved at udsyret B25RA er i samsvar med de grundlæggende krav og øvrige relevante krav i direktiv 1999/5/EF.</p>
<p>С настоящето, Tokai Rika Co., Ltd., декларира, че B25RA е в съответствие със съществените изисквания и другите приложими разпоредби на Директива 1999/5/EC.</p>
<p>Prin prezenta, Tokai Rika Co., Ltd., declară că aparatul B25RA este în conformitate cu cerințele esențiale și cu alte prevederi pertinente ale Directivei 1999/5/CE.</p>
<p>Ovim, Tokai Rika Co., Ltd., izjavljuje da ovaj B25RA je usklađen sa bitnim zahtjevima i drugim relevantnim odredbama Direktive 1999/5/EC.</p>

## 1-2. Opening, closing and locking the doors

### Side doors

The vehicle can be locked and unlocked using the wireless remote control, key or door lock switch.

- **Wireless remote control (if equipped)**

→P. 48

- **Key**

Turning the key operates the doors as follows:

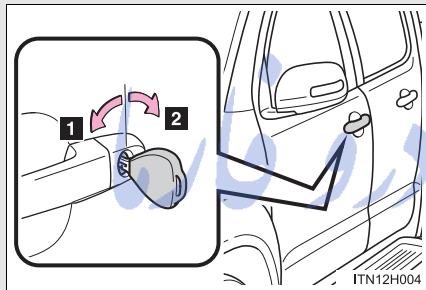

**1** Locks all the doors

**2** Unlocks all the doors

1

Before driving

تلفن شبانه روزی: ۰۲۱-۸۸۶۲۰۸۵

FarmaSOS.com

## 1-2. Opening, closing and locking the doors

### ■ Door lock switch (if equipped)

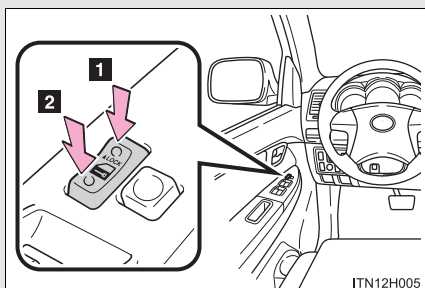

- 1 Locks all the doors
- 2 Unlocks all the doors

### ■ Inside lock buttons

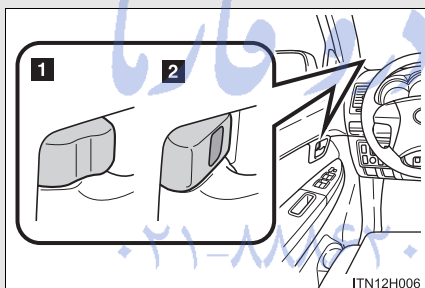

- 1 Locks the door
- 2 Unlocks the door

The driver's door can be opened by pulling the inside handle even if the lock button is in the lock position.

FarmaSOS.com

**Locking the front doors from the outside without a key**

- STEP 1** Move the inside lock button to the lock position.
- STEP 2** Close the door while pulling the door handle.

**Rear door child-protector lock (double-cab models only)**

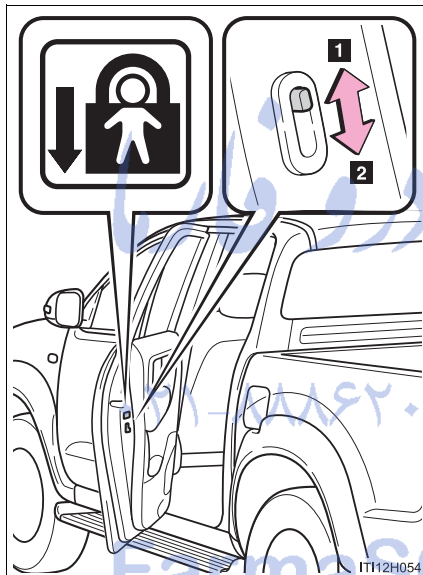

The door cannot be opened from inside the vehicle when the lock is set.

- 1** Unlock
- 2** Lock

These locks can be set to prevent children from opening the rear doors. Push down on each rear door switch to lock both rear doors.

1

Before driving

## 1-2. Opening, closing and locking the doors

### CAUTION

#### ■ To prevent an accident

Observe the following precautions while driving the vehicle.  
Failure to do so may result in a door opening and an occupant falling out, resulting in death or serious injury.

- Always use a seat belt.
- Ensure that all doors are properly closed.
- Do not pull the inside handle of the doors while driving.  
The door may be opened and the passengers are thrown out of the vehicle and it may result in serious injury or death.  
Be especially careful for the driver's door, as the door may be opened even if the inside lock button is in locked position.
- Set the rear door child-protector locks when children are seated in the rear seats.

تلفن شبانه روزی: ۰۲۱-۸۸۶۲۰۸۵

FarmaSOS.com

## 1-2. Opening, closing and locking the doors

### Tailgate\*

The tailgate can be locked/unlocked and opened by the following procedures.

#### ■ Locking and unlocking the tailgate

##### Key (vehicles with key hole)

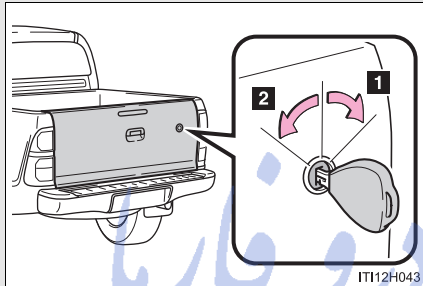

- 1 Locks the tailgate
- 2 Unlocks the tailgate

#### ■ Opening the tailgate

##### Type A

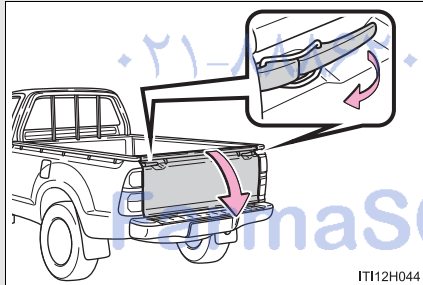

Unlock the latches and open the tailgate slowly.

The support cables will hold the tailgate horizontal.

After closing the tailgate, try pulling it toward you to make sure it is securely locked.

1

Before driving

\*: If equipped

## 1-2. Opening, closing and locking the doors

### Type B

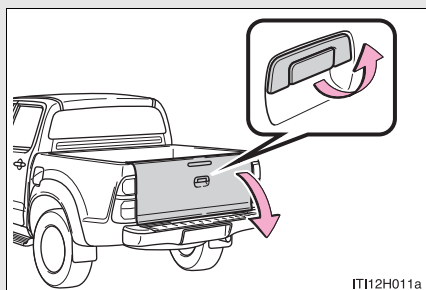

Pull the handle and open the tailgate slowly.

The support cables will hold the tailgate horizontal.

After closing the tailgate, try pulling it toward you to make sure it is securely locked.

### Lowering the tailgate

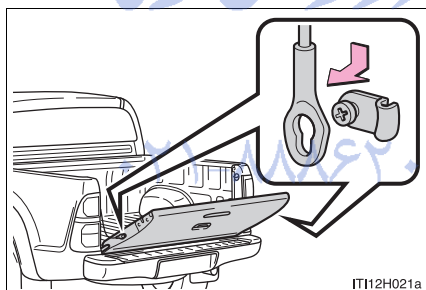

Release the brackets on the support cables from the lugs on both sides as shown in the illustration.



**Rear step bumper (if equipped)**

**Type A**

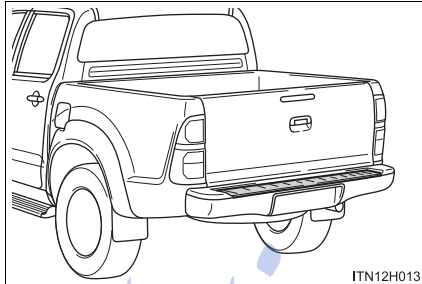

The rear step bumper is for rear end protection and easier step-up loading.

**Type B**

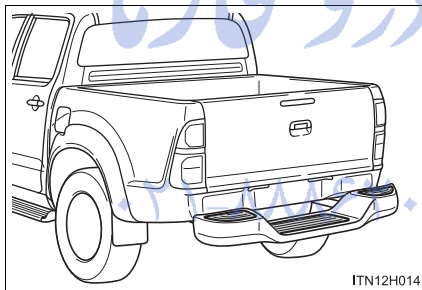

1

Before driving

**⚠ CAUTION**

**■ Caution while driving**

Observe the following precautions.  
Failure to do so may result in death or serious injury.

- Do not drive with the tailgate open.
- Do not get on the rear step bumper.

1-2. Opening, closing and locking the doors

 NOTICE

■ **After closing the tailgate**

Try pulling it toward you to make sure it is securely locked.

■ **To prevent damage to the rear step bumper**

Do not allow more than one person to get on the rear step bumper at a time.

امداد خودرو فارما

تلفن شبانه روزی: ۰۲۱-۸۸۸۶۲۰۸۵

FarmaSOS.com

## 1-3. Adjustable components (seats, mirrors, steering wheel) Front seats

### Manual seat (separated type)

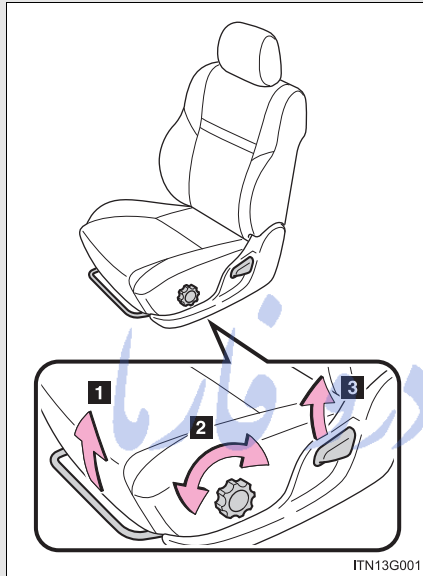

- 1 Seat position adjustment lever
- 2 Vertical height adjustment dial (driver's side only) (if equipped)
- 3 Seatback angle adjustment lever

1

Before driving

امداد خود فاریبا  
تلفن شبانه روزی: ۰۲۱-۸۸۸۶۲۰۸۵  
FarmaSOS.com

1-3. Adjustable components (seats, mirrors, steering wheel)

**Manual seat (bench type)**

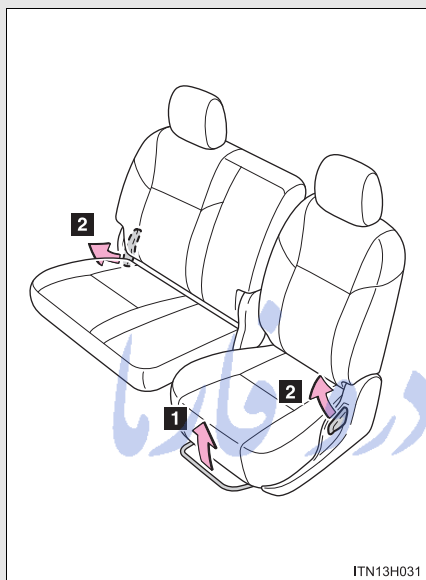

- 1** Seat position adjustment lever (driver's side only)
- 2** Seatback angle adjustment lever

تلفن شبانه روزی: ۰۲۱-۸۸۸۶۲۰۸۵

FarmaSOS.com

1-3. Adjustable components (seats, mirrors, steering wheel)

**Power seat (driver's side only)**

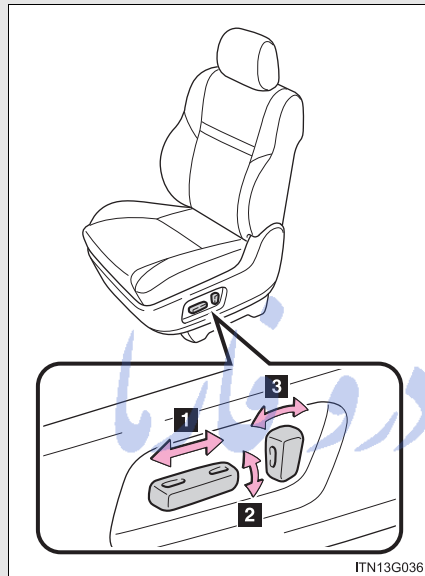

- 1** Seat position adjustment switch
- 2** Vertical height adjustment switch
- 3** Seatback angle adjustment switch

1

Before driving

تلفن شبانه روزی: ۰۲۱-۸۸۸۶۲۰۸۵

FarmaSOS.com

**Moving a front passenger's seat for rear seat access (extra-cab models only)**

■ **Getting in the vehicle**

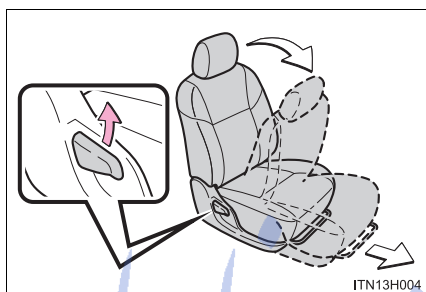

Pull the seatback angle adjustment lever and fold down the seatback. The seat will slide forward.

Move the seat to the front-most position

■ **Getting out of the vehicle**

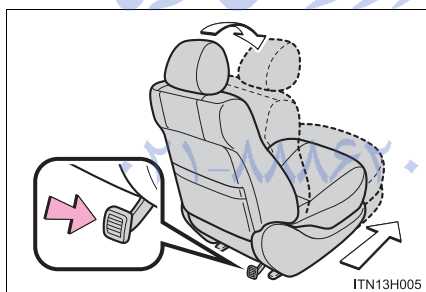

Depress the release pedal and fold down the seatback. The seat will slide forward.

Move the seat to the front-most position

Make sure that no passenger is seated on the front passenger seat before depressing the release pedal.

■ **After passengers have entered/exited the vehicle**

Lift up the seatback and slide the seat backward until it locks.

 CAUTION

■ **Seat adjustment**

- To reduce the risk of sliding under the lap belt during a collision, do not recline the seat more than necessary.

If the seat is too reclined, the lap belt may slide past the hips and apply restraint forces directly to the abdomen, or your neck may contact the shoulder belt, increasing the risk of death or serious injury in the event of an accident.

Adjustments should not be made while driving as the seat may unexpectedly move and cause the driver to lose control of the vehicle.

- Manual seat: After adjusting the seat, make sure that the seat is locked in position.

■ **Caution while driving**

Extra-cab models only: Do not rest your foot on the release pedal behind the passenger seat.

1

Before driving

تلفن شبانه روزی: ۰۲۱-۸۸۶۲۰۸۵

FarmaSOS.com

## 1-3. Adjustable components (seats, mirrors, steering wheel) Rear seats\*

### Extra-cab models

#### ■ Removing the rear seat cushions (if equipped)

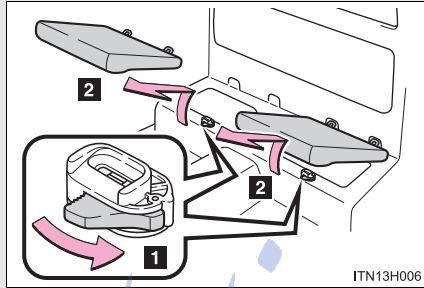

**1** Unhook the lock release lever.

**2** Pull the seat cushions up and then pull toward the front of vehicle.

The seat cushions can be removed separately.

تلفن شبانه روزی: ۰۲۱-۸۸۸۶۲۰۸۵

FarmaSOS.com

\*: If equipped



### Double-cab models

#### ■ Raising the bottom cushion

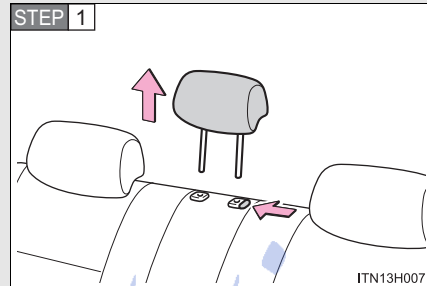

Remove the center head restraint.

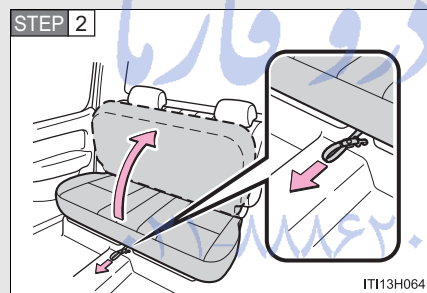

Pull the strap and raise the bottom cushion.

The latch under the bottom cushion will release allowing the bottom cushion to be raised.

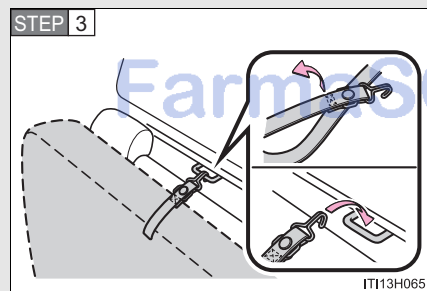

Anchor the strap to the bracket behind the rear seat.

1

Before driving

### 1-3. Adjustable components (seats, mirrors, steering wheel)

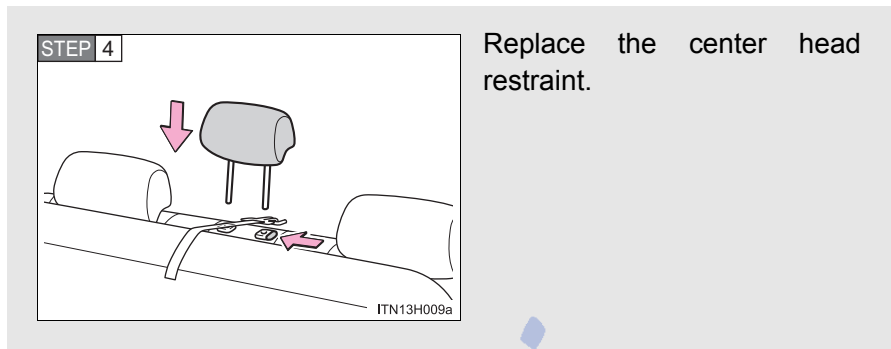

#### ⚠ CAUTION

##### ■ When removing the rear seat cushions (if equipped)

Observe the following precautions. Failure to do so may result in death or serious injury.

- Do not remove the rear seat cushions while driving.
- Be careful not to hit the removed rear seat cushions against a person or drop it on yourself.

##### ■ When reinstalling, returning the rear seat cushions, bottom cushion to their original position

Observe the following precautions. Failure to do so may result in death or serious injury.

- Be careful not to get your hands or feet pinched in the seat.
- Make sure there are no obstacles under the seat which would prevent the seat from properly locking into place.
- Make sure the rear seat cushions, bottom cushion securely locked by pushing it upward and downward.
- Check that the seat belts are not twisted or caught in the seatback.

## 1-3. Adjustable components (seats, mirrors, steering wheel) Head restraints

### Front seats

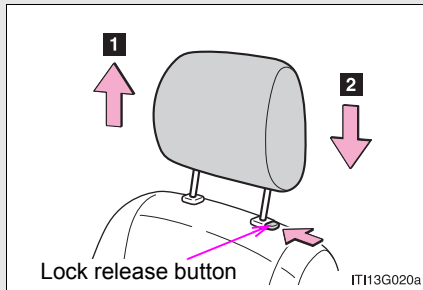

#### 1 Up

Pull the head restraints up.

#### 2 Down

Push the head restraint down while pressing the lock release button.

### Rear seats (double-cab models only)

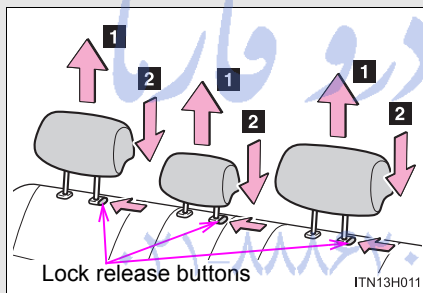

#### 1 Up

Pull the head restraints up.

#### 2 Down

Push the head restraint down while pressing the lock release button.

1

Before driving

FarmaSOS.com

■ **Removing the head restraints**

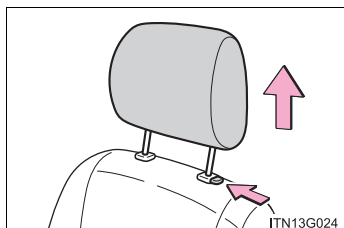

Pull the head restraint up while pressing the lock release button.

■ **Installing the head restraints**

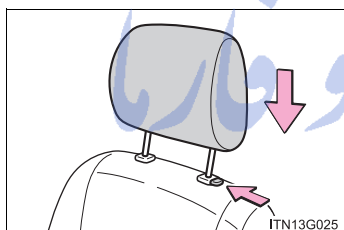

Align the head restraint with the installation holes and push it down to the lock position.

Press and hold the lock release button when lowering the head restraint.

■ **Adjusting the height of the head restraints**

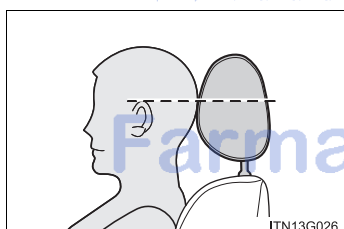

Make sure that the head restraints are adjusted so that the center of the head restraint is closest to the top of your ears.

■ **Adjusting the rear seat head restraint (double-cab models only)**

Always raise the head restraint one level from the stowed position when using.

 CAUTION

■ **Head restraint precautions**

Observe the following precautions regarding the head restraints. Failure to do so may result in death or serious injury.

- Use the head restraints designed for each respective seat.
- Adjust the head restraints to the correct position at all times.
- After adjusting the head restraints, push down on them and make sure they are locked in position.
- Do not drive with the head restraints removed.

1

Before driving

امداد خودرو فارما

تلفن شبانه روزی: ۰۸۵-۸۸۸۶۲-۰۲۱

FarmaSOS.com

## 1-3. Adjustable components (seats, mirrors, steering wheel) Seat belts

Make sure that all occupants are wearing their seat belts before driving the vehicle.

### ■ Correct use of the seat belts

#### 3-point type

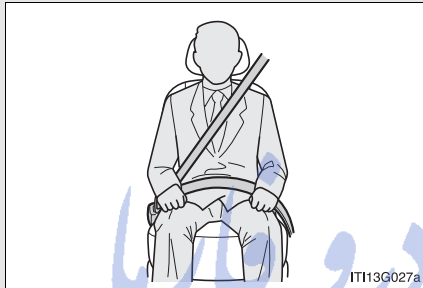

- Extend the shoulder belt so that it comes fully over the shoulder, but does not come into contact with the neck or slide off the shoulder.
- Position the lap belt as low as possible over the hips.
- Adjust the position of the seatback. Sit up straight and well back in the seat.
- Do not twist the seat belt

FarmaSOS.com

### 2-point type (if equipped)

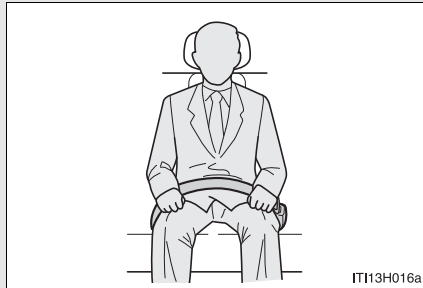

- Position the lap belt as low as possible over the hips.
- Adjust the position of the seatback. Sit up straight and well back in the seat.
- Do not twist the seat belt.

### ■ Fastening and releasing the seat belt

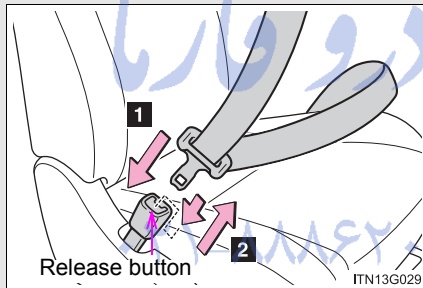

- 1** To fasten the seat belt, push the plate into the buckle until a click sound is heard.
- 2** To release the seat belt, press the release button.

1

Before driving

FarmaSOS.com

■ **Adjusting the seat belt shoulder anchor height (front seats) (if equipped)**

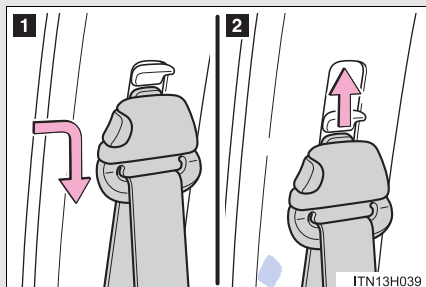

**1** Push the seat belt shoulder anchor down while pressing the release button.

**2** Push the seat belt shoulder anchor up.

Move the height adjuster up and down as needed until you hear a click.

■ **Adjusting the length of the belt (2-point type seat belt) (if equipped)**

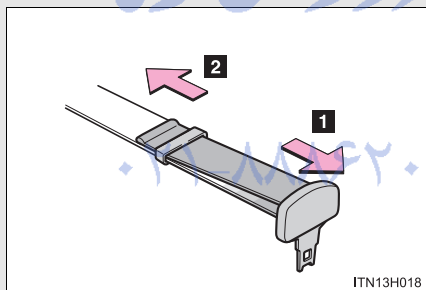

**1** Lengthen

**2** Shorten



### Seat belt pretensioners (front seats)

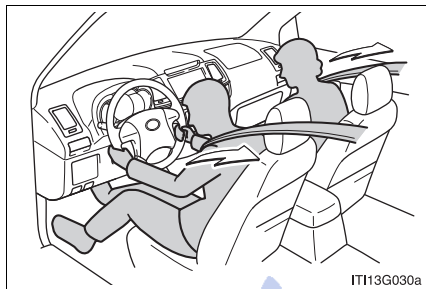

The pretensioner helps the seat belt to quickly restrain the occupant by retracting the seat belt when the vehicle is subjected to certain types of severe frontal collision or side collision (vehicles with SRS side airbags and curtain shield airbags).

The pretensioner may not activate in the event of a minor frontal or side impact, or a rear impact.

1

Before driving

#### ■ Emergency locking retractor (ELR) (3-point type seat belt)

The retractor will lock the belt during a sudden stop or on impact. It may also lock if you lean forward too quickly. A slow, easy motion will allow the belt to extend so that you can move around fully.

FarmaSOS.com

### ■ Pregnant women

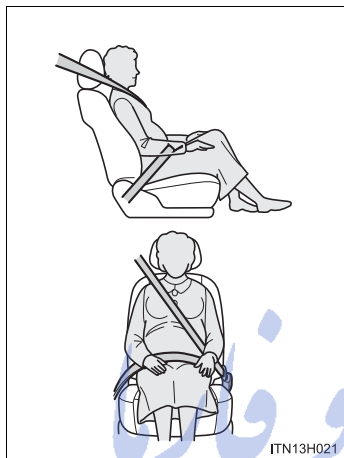

Obtain medical advice and wear the seat belt in the proper way. (→P. 78)

Women who are pregnant should position the lap belt as low as possible over the hips in the same manner as other occupants. Extend the shoulder belt completely over the shoulder and position the belt across the chest. Avoid belt contact over the rounding of the abdominal area.

If the seat belt is not worn properly, not only the pregnant woman, but also the fetus could suffer death or serious injury as a result of sudden braking or a collision.

### ■ People suffering illness

Obtain medical advice and wear the seat belt in the proper way. (→P. 78)

### ■ Child seat belt usage

The seat belts of your vehicle were principally designed for persons of adult size.

- Use a child restraint system appropriate for the child, until the child becomes large enough to properly wear the vehicle's seat belt. (→P. 122)
- When the child becomes large enough to properly wear the vehicle's seat belt, follow the instructions on P. 78 regarding seat belt usage.

### ■ Replacing the belt after the pretensioner has been activated

If the vehicle is involved in multiple collisions, the pretensioner will activate for the first collision, but will not activate for the second or subsequent collisions.

### ■ Seat belt regulations

If seat belt regulations exist in the country where you reside, please contact any authorized Toyota dealer or repairer, or another duly qualified and equipped professional, for seat belt replacement or installation.

 CAUTION

Observe the following precautions to reduce the risk of injury in the event of sudden braking, sudden swerving or an accident.  
Failure to do so may cause death or serious injury.

■ **Wearing a seat belt**

- Ensure that all passengers wear a seat belt.
- Always wear a seat belt properly.
- Each seat belt should be used by one person only. Do not use a seat belt for more than one person at once, including children.
- Toyota recommends that children be seated in the rear seat and always use a seat belt and/or an appropriate child restraint system.
- To achieve a proper seating position, do not recline the seat more than necessary. The seat belt is most effective when the occupants are sitting up straight and well back in the seats.
- Do not wear the shoulder belt under your arm.
- Always wear your seat belt low and snug across your hips.

■ **When children are in the vehicle**

Do not allow children to play with the seat belt. If the seat belt becomes twisted around a child's neck, it may lead to choking or other serious injuries that could result in death.

If this occurs and the buckle cannot be unfastened, scissors should be used to cut the belt.

■ **Seat belt pretensioners**

If the pretensioner has activated, the SRS warning light will come on. In that case, the seat belt cannot be used again and must be replaced at any authorized Toyota dealer or repairer, or another duly qualified and equipped professional.

 CAUTION

■ **Seat belt damage and wear**

- Do not damage the seat belts by allowing the belt, plate, or buckle to be jammed in the door.
- Inspect the seat belt system periodically. Check for cuts, fraying, and loose parts. Do not use a damaged seat belt until it is replaced. Damaged seat belts cannot protect an occupant from death or serious injury.
- Ensure that the belt and plate are locked and the belt is not twisted. If the seat belt does not function correctly, immediately contact any authorized Toyota dealer or repairer, or another duly qualified and equipped professional.
- Replace the seat assembly, including the belts, if your vehicle has been involved in a serious accident, even if there is no obvious damage.
- Do not attempt to install, remove, modify, disassemble or dispose of the seat belts. Have any necessary repairs carried out by any authorized Toyota dealer or repairer, or another duly qualified and equipped professional. Inappropriate handling of the pretensioner may prevent it from operating properly, resulting in death or serious injury.

FarmaSOS.com

### 1-3. Adjustable components (seats, mirrors, steering wheel) Steering wheel

The steering wheel can be adjusted to a comfortable position.

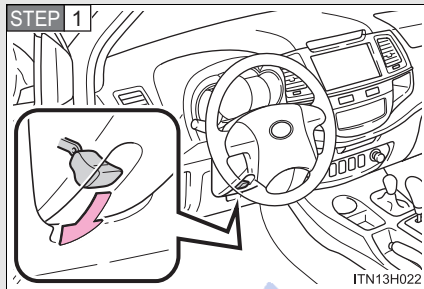

Hold the steering wheel and push the lever down.

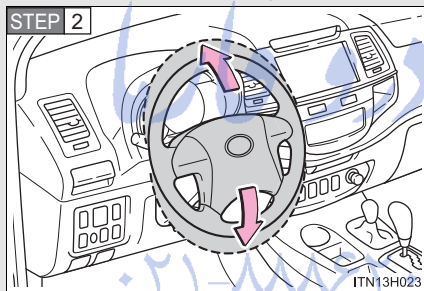

Adjust to the ideal position by moving the steering wheel.

After adjustment, pull the lever up to secure the steering wheel.

1

Before driving

#### ⚠ CAUTION

##### ■ Caution while driving

Do not adjust the steering wheel while driving. Doing so may cause the driver to mishandle the vehicle and cause an accident, resulting in death or serious injury.

##### ■ After adjusting the steering wheel

Make sure that the steering wheel is securely locked. Otherwise, the steering wheel may move suddenly, possibly causing an accident, and resulting in death or serious injury.

### 1-3. Adjustable components (seats, mirrors, steering wheel) Inside rear view mirror

Glare from the headlights of vehicles behind can be reduced by using the following functions:

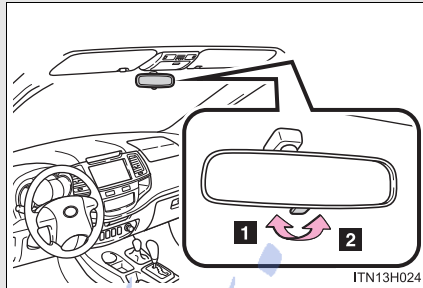

- 1 Normal position
- 2 Anti-glare position

#### Adjusting the height of rear view mirror

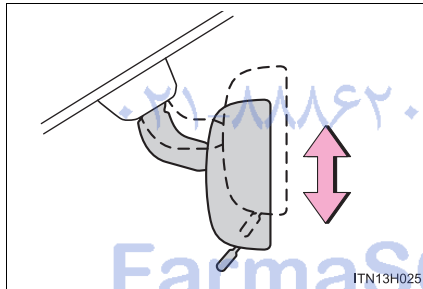

Adjust the height of the rear view mirror by moving it up and down.

1-3. Adjustable components (seats, mirrors, steering wheel)

 CAUTION

■ **Caution while driving**

Do not adjust the position of the mirror while driving.  
Doing so may lead to mishandling of the vehicle and cause an accident,  
resulting in death or serious injury.

1

Before driving

امداد خودرو فارما

تلفن شبانه روزی: ۰۲۱-۸۸۸۶۲۰۸۵

FarmaSOS.com

## 1-3. Adjustable components (seats, mirrors, steering wheel) Outside rear view mirrors

Mirror angle can be adjusted.

### Manual adjustable type

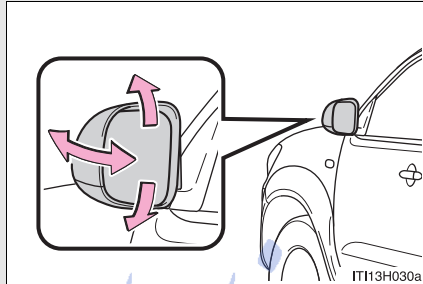

Adjust a mirror.

### Power adjustable type

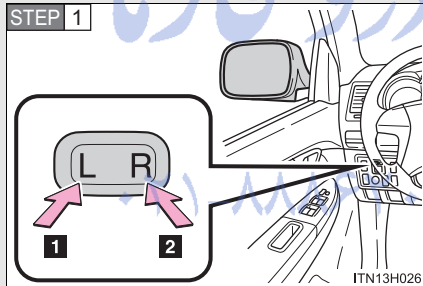

To select a mirror to adjust, press the switch.

- 1** Left
- 2** Right

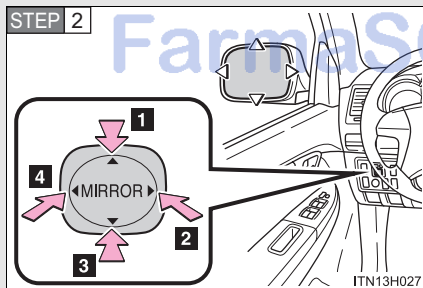

To adjust the mirror, press the switch.

- 1** Up
- 2** Right
- 3** Down
- 4** Left



### Folding the mirrors

#### Manual folding type

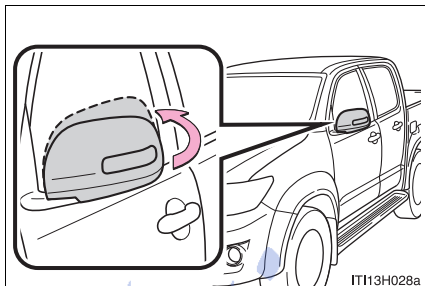

Push the mirror back in the direction of the vehicle's rear.

#### Auto folding type

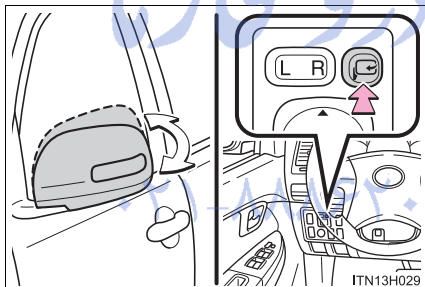

Press the switch to fold the mirrors.

Press it again to extend them to the original position.

1

Before driving

FarmaSOS.com

■ **Mirror angle can be adjusted when (power adjustable type)**

The engine switch is in the “ACC” or “ON” position.

■ **When the mirrors are fogged up**

Turn on the mirror defoggers to defog the mirrors. (→P. 266)

 **CAUTION**

■ **When driving the vehicle**

Observe the following precautions while driving.  
Failure to do so may result in loss of control of the vehicle and cause an accident, resulting in death or serious injury.

- Do not adjust the mirrors while driving.
- Do not drive with the mirrors folded.
- Both the driver and passenger side mirrors must be extended and properly adjusted before driving.

■ **When a mirror is moving (power adjustable type)**

To avoid personal injury and mirror malfunction, be careful not to get your hand caught by the moving mirror.

■ **When the mirror defoggers are operating**

Do not touch the rear view mirror surfaces, as they can become very hot and burn you.

 **NOTICE**

■ **If ice should jam the mirror**

Do not operate the control or scrape the mirror face. Use a spray de-icer to free the mirror.

## 1-4. Opening and closing the windows Power windows\*

The power windows can be opened and closed using the switches.

Operating the switch moves the windows as follows:

### Type A

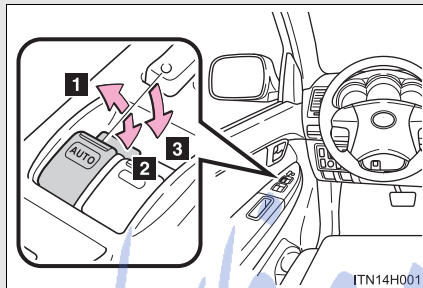

- 1 Closing
- 2 Opening
- 3 One-touch opening\*  
(driver's window only)

\*: Pushing the switch in the opposite direction will stop window travel partway.

### Type B

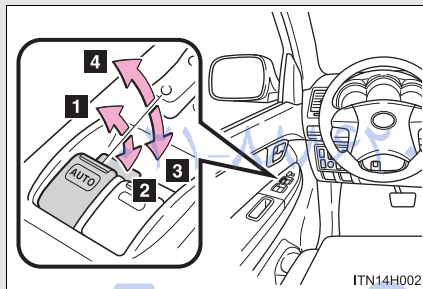

- 1 Closing
- 2 Opening
- 3 One-touch opening\*  
(driver's window only)
- 4 One-touch closing\*  
(driver's window only)

\*: Pushing the switch in the opposite direction will stop window travel partway.

1

Before driving

\*: If equipped

## 1-4. Opening and closing the windows

### Window lock switch

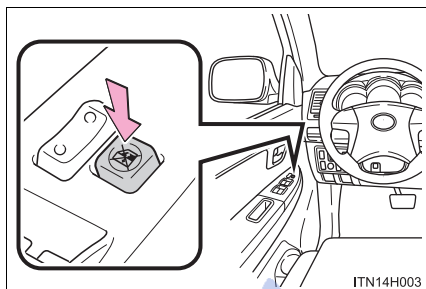

Press the switch down to lock the passenger window switches.

Use this switch to prevent children from accidentally opening or closing a passenger window.

- **The power windows can be operated when**

The engine switch is in the “ON” position.

- **Jam protection function (type B)**

If an object becomes caught between the window and the window frame, window travel is stopped and the window is opened slightly.

- **If the battery is disconnected (driver's window only) (type B)**

The power windows must be initialized in order to ensure proper operation.

**STEP 1** Open the window halfway.

**STEP 2** Fully close the window by pulling the switch up and continue holding the switch for 1 second.

The indicator on the switch changes from a flashing pattern to being on when initial settings are complete.

 CAUTION

■ **Closing the windows**

Observe the following precautions.

Failure to do so may result in death or serious injury.

- Check to make sure that all passengers do not have any part of their body in a position where it could be caught when a window is being operated.
- Do not allow children to operate the power windows.  
Closing a power window on someone can cause serious injury, and in some instances, even death.

■ **Jam protection function (type B)**

- Never use any part of your body to intentionally activate the jam protection function.
- The jam protection function may not work if something gets caught just before the window fully closes.

1

Before driving

تلفن شبانه روزی: ۰۲۱-۸۸۶۲۰۸۵

FarmaSOS.com

## 1-4. Opening and closing the windows Quarter windows (extra-cab models)

The quarter windows can be opened and closed using the latch handle.

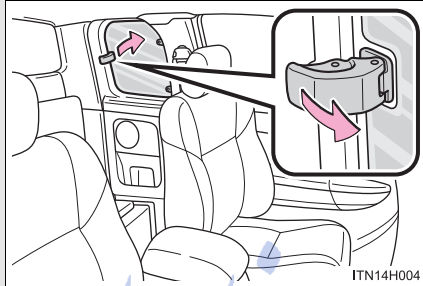

To open the quarter windows, pull the latch handle toward you and swing it fully out.

### ■ Closing the quarter windows

Make sure that the quarter windows are securely closed after closing them.

### ⚠ CAUTION

#### ■ Opening or closing the quarter windows

Observe the following precautions.

Failure to do so may result in death or serious injury.

- Check to make sure that all passengers do not have any part of their body in a position where it could be caught when a window is being operated.
- Do not allow children to operate the quarter windows.  
Closing a quarter window on someone can cause serious injury, and in some instances, even death.

## 1-4. Opening and closing the windows Back window (vehicles with sliding type)

The back window can be opened and closed using the lock release lever.

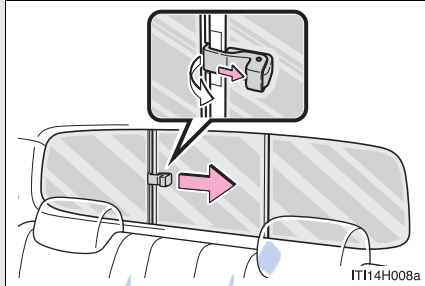

To open the back window, push the lock release lever and slide the back window.

1

Before driving

### ■ Closing the back window

Make sure that the back window is securely closed after closing it.

### ⚠ CAUTION

#### ■ Opening or closing the back window

Observe the following precautions.

Failure to do so may result in death or serious injury.

- Check to make sure that all passengers do not have any part of their body in a position where it could be caught when the window is being operated.
- Do not allow children to operate the back window.  
Closing the back window on someone can cause serious injury, and in some instances, even death.

## 1-5. Refueling

### Opening the fuel tank cap

Perform the following steps to open the fuel tank cap:

#### ■ Before refueling the vehicle

Turn the engine switch off and ensure that all the doors and windows are closed.

#### ■ Opening the fuel tank cap

##### Type A

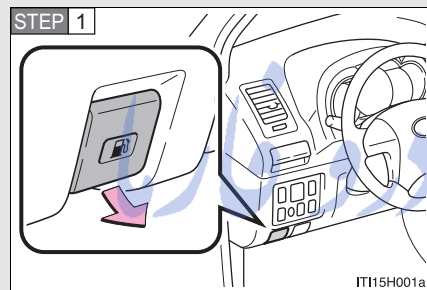

Pull up the opener to open the fuel filler door.

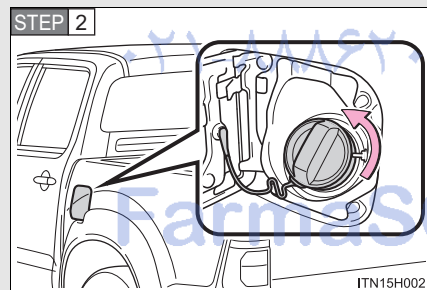

Turn the fuel tank cap slowly to open.

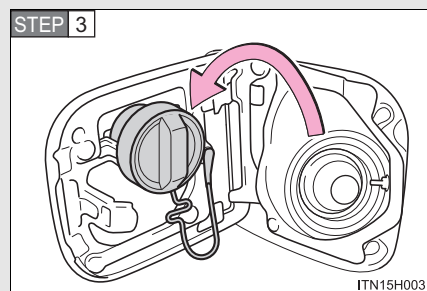

Hang the fuel tank cap on the back of the fuel filler door.



**Type B**

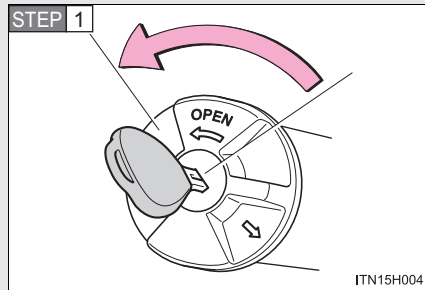

To unlock the fuel tank cap, insert the key and turn it counterclockwise.

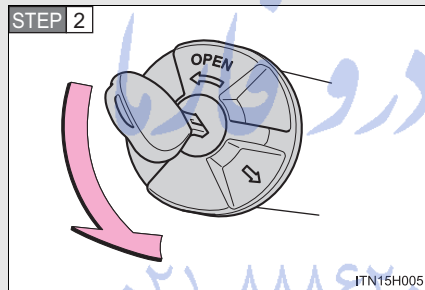

Turn the fuel tank cap slowly to open.

1

Before driving

FarmaSOS.com

### Closing the fuel tank cap

#### Type A

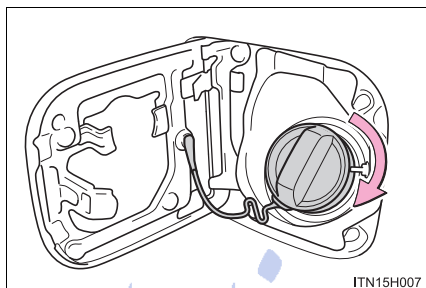

After refueling, turn the fuel tank cap until you hear a click. Once the cap is released, it will turn slightly in the opposite direction.

#### Type B

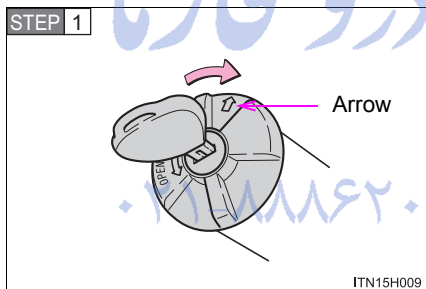

Close the fuel tank cap

Make sure to put the fuel tank cap with the arrow upward and turn it slowly to close.

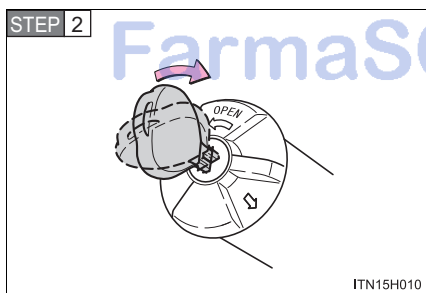

Lock the fuel cap

Turning the fuel cap key clockwise.

■ **Fuel types**

**EU area:**

Diesel fuel conforming to European standard EN590

**Except EU area (except Russia):**

Diesel fuel that contains 50 ppm or less of sulfur and has a cetane number of 48 or higher

**Except EU area (Russia):**

Diesel fuel, Cetane number 48 or higher

Your vehicle must use only diesel fuel conforming to GOST R52368-2005 (Sulfur max 50 ppm).

■ **Fuel tank capacity**

Approximately 80 L (21.1 gal., 17.6 Imp.gal.)

1

Before driving

تلفن شبانه روزی: ۰۲۱-۸۸۸۶۲۰۸۵

FarmaSOS.com

 CAUTION

■ **When refueling the vehicle**

Observe the following precautions while refueling the vehicle. Failure to do so may result in death or serious injury.

- After exiting the vehicle and before opening the fuel door, touch an unpainted metal surface to discharge any static electricity. It is important to discharge static electricity before refueling because sparks resulting from static electricity can cause fuel vapors to ignite while refueling.
- Type A only: Always hold the grips on the fuel tank cap and turn it slowly to remove it.  
A whooshing sound may be heard when the fuel tank cap is loosened. Wait until the sound cannot be heard before fully removing the cap. In hot weather, pressurized fuel may spray out the filler neck and cause injury.
- Do not allow anyone that has not discharged static electricity from their body to come close to an open fuel tank.
- Do not inhale vaporized fuel.  
Fuel contains substances that are harmful if inhaled.
- Do not smoke while refueling the vehicle.  
Doing so may cause the fuel to ignite and cause a fire.
- Do not return to the vehicle or touch any person or object that is statically charged.  
This may cause static electricity to build up, resulting in a possible ignition hazard.

■ **When refueling**

Securely insert the fuel nozzle into the fuel filler neck. If fuel is added with the nozzle slightly lifted away from the fuel filler neck, the automatic shut off function may not operate, resulting in fuel overflowing from the tank.

■ **When replacing the fuel cap**

Do not use anything but a genuine Toyota fuel tank cap designed for your vehicle. Doing so may cause a fire or other incident which may result in death or serious injury.

 NOTICE

■ Refueling

Do not spill fuel during refueling.  
Doing so may damage the vehicle, such as causing the emission control system to operate abnormally or damaging fuel system components or the vehicle's painted surface.

1

Before driving

امداد خودرو فارما

تلفن شبانه روزی: ۰۲۱-۸۸۸۶۲۰۸۵

FarmaSOS.com

## 1-6. Theft deterrent system Engine immobilizer system

The vehicle's keys have built-in transponder chips that prevent the engine from starting if a key has not been previously registered in the vehicle's on-board computer.

Never leave the keys inside the vehicle when you leave the vehicle.

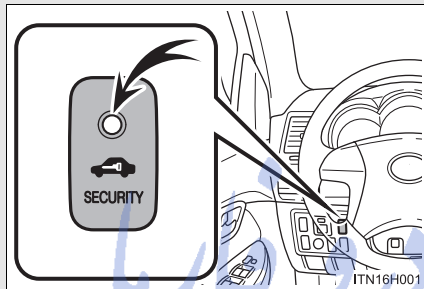

The indicator light flashes after the key has been removed from the engine switch to indicate that the system is operating.

The indicator light stops flashing after the registered key has been inserted into the engine switch to indicate that the system has been canceled.

تلفن شبانه روزی: ۰۲۱-۸۸۶۲۰۸۵

### ■ System maintenance

The vehicle has a maintenance-free type engine immobilizer system.

### ■ Conditions that may cause the system to malfunction

- If the grip portion of the key is in contact with a metallic object
- If the key is in close proximity to or touching a key to the security system (key with a built-in transponder chip) of another vehicle

■ **Certification for the engine immobilizer system**

Hereby, Tokai Rika Co., Ltd., declares that this RI-33BTY is in compliance with the essential requirements and other relevant provisions of Directive 1999/5/EC.

**TOKAI RIKA**

1

Before driving

**R&TTE Declaration of Conformity**

We,

Manufacturer's Name: Tokai Rika Co., Ltd.  
 Manufacturer's Address: 260, Toyota 3-chome, Oguchi-cho, Niwa-gun, Aichi-ken,  
 480-0195, Japan

hereby declare under our sole responsibility that the product:

Product Name: Immobilizer  
 Product Model: RI-33BTY

to which this declaration relates is in conformity with the essential requirements and other relevant requirements of the R&TTE Directive (1999/5/EC). The product is compliant with the following standards and/or other normative documents:

Safety: EN60950-1  
 EMC: EN301 489-1 & -3  
 Spectrum: EN300 330-2

Supplementary information:

* CE mark	
* Member states intended for use	EU and EFTA
* Member states with restrictive use	None

Date: 6 February 2008

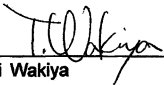
Signature: 

Position of the signatory: Tadashi Wakiya  
 General Manager,  
 Electronics Engineering Div.

## 1-6. Theft deterrent system

<p>Hereby, Tokai Rika Co., Ltd., declares that this RI-33BTY is in compliance with the essential requirements and other relevant provisions of Directive 1999/5/EC.</p>
<p>Tokai Rika Co., Ltd. vakuuttaa täten että RI-33BTY tyyppinen laite on direktiivin 1999/5/EY oleellisten vaatimusten ja sitä koskevien direktiivin muiden ehtojen mukainen.</p>
<p>Hierbij verklaart Tokai Rika Co., Ltd. dat het toestel RI-33BTY in overeenstemming is met de essentiële eisen en de andere relevante bepalingen van richtlijn 1999/5/EG.</p>
<p>Par la présente Tokai Rika Co., Ltd. déclare que l'appareil RI-33BTY est conforme aux exigences essentielles et aux autres dispositions pertinentes de la directive 1999/5/CE.</p>
<p>Härmed intygar Tokai Rika Co., Ltd. att denna RI-33BTY står i överensstämmelse med de väsentliga egenskapskrav och övriga relevanta bestämmelser som framgår av direktiv 1999/5/EG.</p>
<p>Undertegnede Tokai Rika Co., Ltd. erklærer herved, at følgende udstyr RI-33BTY overholder de væsentlige krav og øvrige relevante krav i direktiv 1999/5/EF.</p>
<p>Hiermit erklärt Tokai Rika Co., Ltd., dass sich das Gerät RI-33BTY in Übereinstimmung mit den grundlegenden Anforderungen und den übrigen einschlägigen Bestimmungen der Richtlinie 1999/5/EG befindet.</p>
<p>ΜΕ ΤΗΝ ΠΑΡΟΥΣΑ Tokai Rika Co., Ltd. ΔΗΛΩΝΕΙ ΟΤΙ RI-33BTY ΣΥΜΜΟΡΦΩΝΕΤΑΙ ΠΡΟΣ ΤΙΣ ΟΥΣΙΩΔΕΙΣ ΑΠΑΙΤΗΣΕΙΣ ΚΑΙ ΤΙΣ ΛΟΙΠΕΣ ΣΧΕΤΙΚΕΣ ΔΙΑΤΑΞΕΙΣ ΤΗΣ ΟΔΗΓΙΑΣ 1999/5/ΕΚ.</p>
<p>Con la presente Tokai Rika Co., Ltd. dichiara che questo RI-33BTY è conforme ai requisiti essenziali ed alle altre disposizioni pertinenti stabilite dalla direttiva 1999/5/CE.</p>
<p>Por medio de la presente Tokai Rika Co., Ltd. declara que el RI-33BTY cumple con los requisitos esenciales y cualesquiera otras disposiciones aplicables o exigibles de la Directiva 1999/5/CE.</p>
<p>Tokai Rika Co., Ltd. declara que este RI-33BTY está conforme com os requisitos essenciais e outras disposições da Directiva 1999/5/CE.</p>
<p>Hawnhekk, Tokai Rika Co., Ltd., jiddikjara li dan RI-33BTY jikkonforma mal-htigijiet essenzjali u ma provvedimenti oħrajn relevanti li hemm fid-Dirrettiva 1999/5/EC.</p>



Käesolevaga kinnitab Tokai Rika Co., Ltd. seadme RI-33BTY vastavust direktiivi 1999/5/EÜ põhinõuetele ja nimetatud direktiivist tulenevatele teistele asjakohastele sätetele.
Alulírott, Tokai Rika Co., Ltd. nyilatkozom, hogy a RI-33BTY megfelel a vonatkozó alapvető követelményeknek és az 1999/5/EC irányelv egyéb előírásainak.
Tokai Rika Co., Ltd. týmto vyhlasuje, že RI-33BTY spĺňa základné požiadavky a všetky príslušné ustanovenia Smernice 1999/5/ES.
Tokai Rika Co., Ltd. tímto prohlašuje, že tento RI-33BTY je ve shodě se základními požadavky a dalšími příslušnými ustanoveními směrnice 1999/5/ES.
Tokai Rika Co., Ltd. izjavlja, da je ta RI-33BTY v skladu z bistvenimi zahtevami in ostalimi relevantnimi določili direktive 1999/5/ES.
Šiuo Tokai Rika Co., Ltd. deklaruoja, kad šis RI-33BTY atitinka esminius reikalavimus ir kitas 1999/5/EB Direktyvos nuostatas.
Ar šo Tokai Rika Co., Ltd. deklarē, ka RI-33BTY atbilst Direktīvas 1999/5/EK būtiskajām prasībām un citiem ar to saistītajiem noteikumiem.
Niniejszym Tokai Rika Co., Ltd. oświadcza, że RI-33BTY jest zgodny z zasadniczymi wymogami oraz pozostałymi stosownymi postanowieniami Dyrektywy 1999/5/EC.
Hér með lýsir Tokai Rika Co., Ltd. yfir því að RI-33BTY er í samræmi við grunnkröfur og aðrar kröfur, sem gerðar eru í tilskipun 1999/5/EC.
Tokai Rika Co., Ltd. erklærer herved at udsyret RI-33BTY er i samsvar med de grundlæggende krav og øvrige relevante krav i direktiv 1999/5/EF.
С настоящето, Tokai Rika Co., Ltd., декларира, че RI-33BTY е в съответствие със съществените изисквания и другите приложими разпоредби на Директива 1999/5/EC.
Prin prezenta, Tokai Rika Co., Ltd., declară că aparatul RI-33BTY este în conformitate cu cerințele esențiale și cu alte prevederi pertinente ale Directivei 1999/5/CE.
Ovim, Tokai Rika Co., Ltd., izjavljuje da ovaj RI-33BTY je usklađen sa bitnim zahtjevima i drugim relevantnim odredbama Direktive 1999/5/EC.

1

Before driving

## 1-6. Theft deterrent system

### NOTICE

#### ■ To ensure the system operates correctly

Do not modify or remove the system. If modified or removed, the proper operation of the system cannot be guaranteed.

امداد خودرو فارما

تلفن شبانه روزی: ۰۲۱-۸۸۸۶۲۰۸۵

FarmaSOS.com

## 1-7. Safety information

### Correct driving posture

Drive with a good posture as follows:

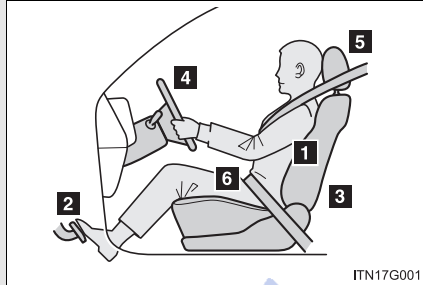

- 1 Sit upright and well back in the seat. (→P. 67)
- 2 Adjust the position of the seat forward or backward to ensure the pedals can be reached and easily depressed to the extent required. (→P. 67)
- 3 Adjust the seatback so that the controls are easily operable. (→P. 67)
- 4 Adjust the tilt position of the steering wheel downward so the airbag is facing your chest. (→P. 85)
- 5 Lock the head restraint in place with the center of the head restraint closest to the top of your ears. (→P. 75)
- 6 Wear the seat belt correctly. (→P. 78)

1

Before driving

 CAUTION

■ **While driving**

- Do not adjust the position of the driver's seat.  
Doing so could cause the driver to lose control of the vehicle.
- Do not place a cushion between the driver or passenger and the seatback.  
A cushion may prevent correct posture from being achieved, and reduce the effectiveness of the seat belt and head restraint, increasing the risk of death or serious injury to the driver or passenger.
- Do not place anything under the front seats.  
Objects placed under the front seats may become jammed in the seat tracks and stop the seat from locking in place. This may lead to an accident, resulting in death or serious injury. The adjustment mechanism may also be damaged.

■ **Adjusting the seat position**

- Take care when adjusting the seat position to ensure that other passengers are not injured by the moving seat.
- Do not put your hands under the seat or near the moving parts to avoid injury.  
Fingers or hands may become jammed in the seat mechanism.

FarmaSOS.com

## 1-7. Safety information

### SRS airbags

The SRS airbags inflate when the vehicle is subjected to certain types of severe impacts that may cause significant injury to the occupants. They work together with the seat belts to help reduce the risk of death or serious injury.

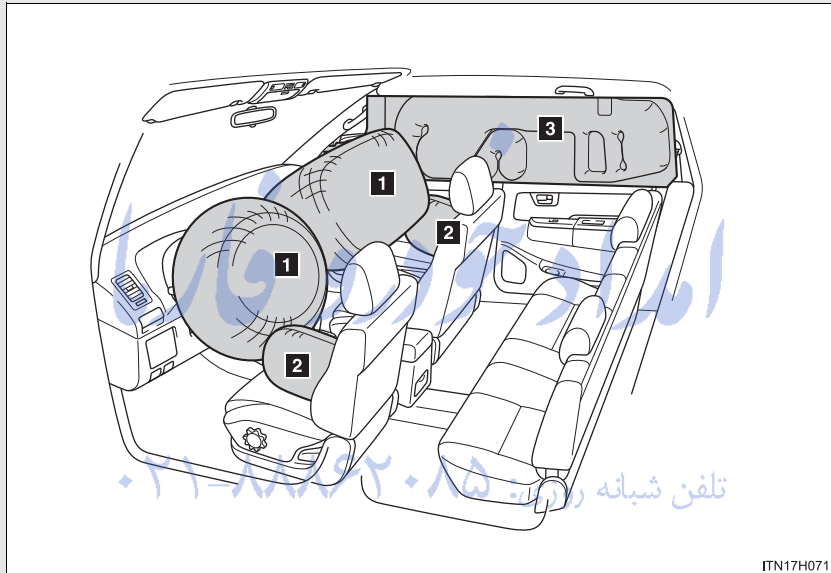

#### SRS front airbags

**1** SRS driver airbag/front passenger airbag

Can help protect the head and chest of the driver and front passenger from impact with interior components

1

Before driving

### SRS side and curtain shield airbags

- 2** SRS side airbags (if equipped)  
Can help protect the torso of the front seat occupants
- 3** SRS curtain shield airbags (if equipped)  
Can help protect primarily the head of occupants in the outer seats

### SRS airbag system components

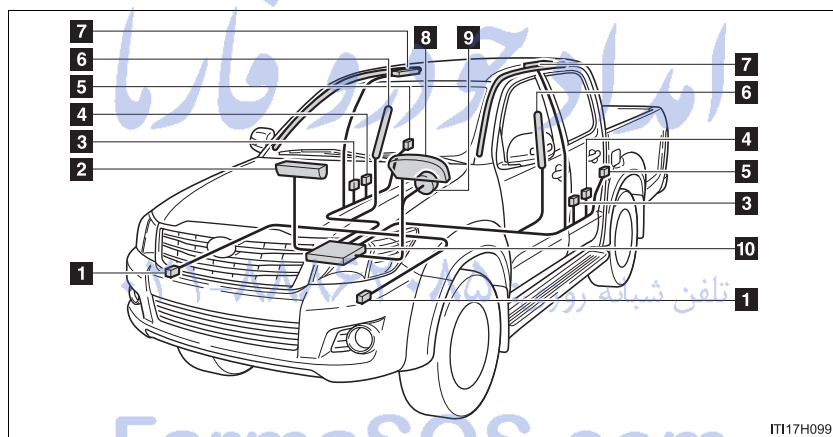

- 1** Front airbag sensors
- 2** Front passenger airbag
- 3** Side and curtain shield airbag sensors (if equipped)
- 4** Seat belt pretensioners and force limiters
- 5** Curtain shield airbag sensors (if equipped)
- 6** Side airbags (if equipped)
- 7** Curtain shield airbags (if equipped)
- 8** SRS warning light
- 9** Driver airbag
- 10** Airbag sensor assembly

The main SRS airbag system components are shown above. The SRS airbag system is controlled by the airbag sensor assembly. As the airbags deploy, a chemical reaction in the inflators quickly fills the airbags with non-toxic gas to help restrain the motion of the occupants.

Bench type front seat: The SRS airbags are designed to protect the driver and front outside passenger, and they are not designed to protect an occupant in the front center seating position.

1

Before driving

امداد خودرو فارما

تلفن شبانه روزی: ۰۲۱-۸۸۸۶۲۰۸۵

FarmaSOS.com

---

■ **If the SRS airbags deploy (inflate)**

- Bruising and slight abrasions may result from contact with a deploying (inflating) SRS airbag.
- A loud noise and white powder will be emitted.
- Vehicles without SRS curtain shield airbags: Parts of the airbag module (steering wheel hub, airbag cover and inflator) as well as the seats may be hot for several minutes. The airbag itself may also be hot.
- Vehicles with SRS curtain shield airbags: Parts of the airbag module (steering wheel hub, airbag cover and inflator) as well as the seats, parts of the front and rear pillars, and roof side rails, may be hot for several minutes. The airbag itself may also be hot.
- The windshield may crack.

■ **SRS airbag deployment conditions (SRS front airbags)**

- The SRS front airbags will deploy in the event of an impact that exceeds the set threshold level (the level of force corresponding to an approximately 20 - 30 km/h [12 - 18 mph] frontal collision with a fixed wall that does not move or deform).

However, this threshold velocity will be considerably higher if the vehicle strikes an object, such as a parked vehicle and sign pole, which can move or deform on impact, or if the vehicle is involved in an underride collision (e.g. a collision in which the front of the vehicle “underrides”, or goes under, the bed of a truck etc.).

- Depending on the type of collision, it is possible that only the seat belt pretensioners will activate.

■ **SRS airbag deployment conditions (SRS side airbags and curtain shield airbags)**

The SRS side airbags and curtain shield airbags will deploy in the event of an impact that exceeds the set threshold level (the level of force corresponding to the impact force produced by an approximately 1500 kg [3300 lb.] vehicle colliding with the vehicle cabin from a direction perpendicular to the vehicle orientation at an approximate speed of 20 - 30 km/h [12 - 18 mph]).



■ **Conditions under which the SRS airbags may deploy (inflate), other than a collision (SRS front airbags)**

The SRS front airbags may also deploy if a serious impact occurs to the underside of your vehicle. Some examples are shown in the illustration.

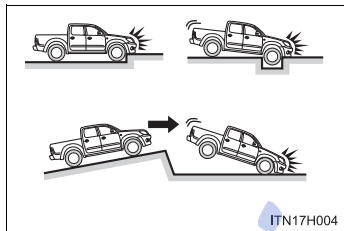

- Hitting a curb, edge of pavement or hard surface
- Falling into or jumping over a deep hole
- Landing hard or falling

■ **Types of collisions that may not deploy the SRS airbags (SRS front airbags)**

The SRS front airbags are generally not designed to inflate if the vehicle is involved in a side or rear collision, if it rolls over, or if it is involved in a low-speed frontal collision. But, whenever a collision of any type causes sufficient forward deceleration of the vehicle, deployment of the SRS front airbags may occur.

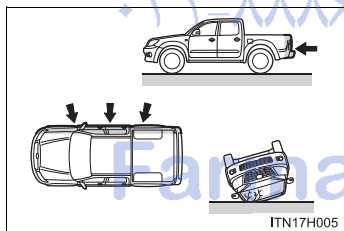

- Collision from the side
- Collision from the rear
- Vehicle rollover

■ **Types of collisions that may not deploy the SRS airbags  
(SRS side airbags and curtain shield airbags)**

The SRS side airbag and curtain shield airbag system may not activate if the vehicle is subjected to a collision from the side at certain angles, or a collision to the side of the vehicle body other than the passenger compartment.

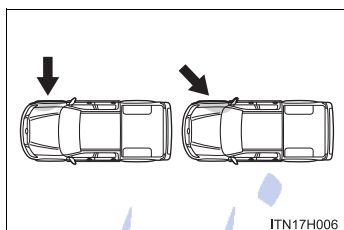

- Collision from the side to the vehicle body other than the passenger compartment
- Collision from the side at an angle

The SRS side airbags and curtain shield airbags are not generally designed to inflate if the vehicle is involved in a frontal or rear collision, if it rolls over, or if it is involved in a low-speed side collision.

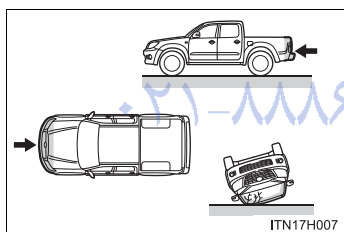

- Collision from the front
- Collision from the rear
- Vehicle rollover

■ **When to contact any authorized Toyota dealer or repairer, or another duly qualified and equipped professional**

In the following cases, contact any authorized Toyota dealer or repairer, or another duly qualified and equipped professional as soon as possible.

- Any of the SRS airbags have been inflated.

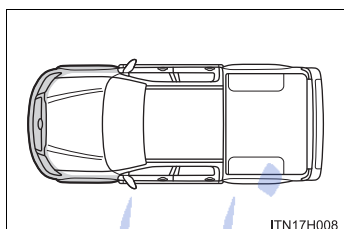

- The front of the vehicle is damaged or deformed, or was involved in an accident that was not severe enough to cause the SRS airbags to inflate.

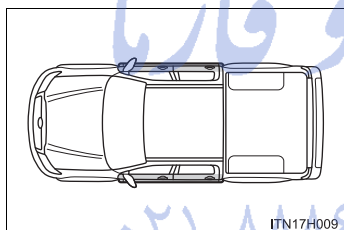

- A portion of a door is damaged or deformed, or the vehicle was involved in an accident that was not severe enough to cause the SRS side airbags and curtain shield airbags to inflate.

1

Before driving

FarmaSOS.com

## 1-7. Safety information

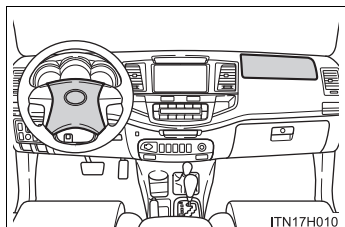

- The pad section of the steering wheel or dashboard near the front passenger airbag is scratched, cracked, or otherwise damaged.

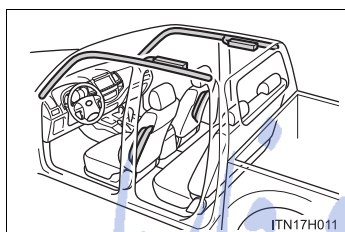

- The surface of the seats with the side airbag is scratched, cracked, or otherwise damaged.
- The portion of the front pillars, rear pillars or roof side rail garnishes (padding) containing the curtain shield airbags inside is scratched, cracked, or otherwise damaged.

تلفن شبانه روزی: ۰۲۱-۸۸۶۲۰۸۵

FarmaSOS.com

**⚠ CAUTION****■ SRS airbag precautions**

Observe the following precautions regarding the SRS airbags. Failure to do so may cause death or serious injury.

- The driver and all passengers in the vehicle must wear their seat belts properly.  
The SRS airbags are supplemental devices to be used with the seat belts.
- The SRS driver airbag deploys with considerable force, and can cause death or serious injury especially if the driver is very close to the airbag.

Since the risk zone for the driver's airbag is the first 50 - 75 mm (2 - 3 in.) of inflation, placing yourself 250 mm (10 in.) from your driver airbag provides you with a clear margin of safety. This distance is measured from the center of the steering wheel to your breastbone. If you sit less than 250 mm (10 in.) away now, you can change your driving position in several ways:

- Move your seat to the rear as far as you can while still reaching the pedals comfortably.
- Slightly recline the back of the seat.  
Although vehicle designs vary, many drivers can achieve the 250 mm (10 in.) distance, even with the driver seat all the way forward, simply by reclining the back of the seat somewhat. If reclining the back of your seat makes it hard to see the road, raise yourself by using a firm, non-slippery cushion, or raise the seat if your vehicle has that feature.
- If your steering wheel is adjustable, tilt it downward. This points the airbag toward your chest instead of your head and neck.

The seat should be adjusted as recommended above, while still maintaining control of the foot pedals, steering wheel, and your view of the instrument panel controls.

1

Before driving

 CAUTION

■ SRS airbag precautions

- The SRS front passenger airbag also deploys with considerable force, and can cause death or serious injury especially if the front passenger is very close to the airbag. The front passenger seat should be as far from the airbag as possible with the seatback adjusted, so the front passenger sits upright.
- Improperly seated and/or restrained infants and children can be killed or seriously injured by a deploying airbag. An infant or child who is too small to use a seat belt should be properly secured using a child restraint system. Toyota strongly recommends that all infants and children be placed in the rear seats of the vehicle and properly restrained. The rear seats are safer for infants and children than the front passenger seat. (→P. 122)

تلفن شبانه روزی: ۰۲۱-۸۸۶۲۰۸۵

FarmaSOS.com

**CAUTION**

**SRS airbag precautions**

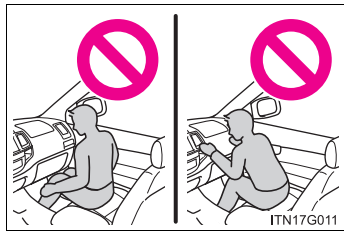

- Do not sit on the edge of the seat or lean against the dashboard.

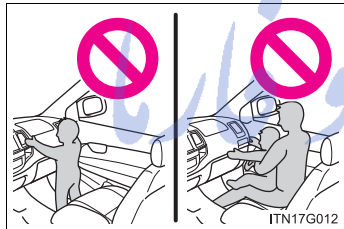

- Do not allow a child to stand in front of the SRS front passenger airbag unit or sit on the knees of a front passenger.
- Do not allow the front seat occupants to hold items on their knees.



- Vehicles with SRS side and curtain shield airbags: Do not lean against the door, the roof side rail or the front, side and rear pillars.



- Vehicles with SRS side and curtain shield airbags: Do not allow anyone to kneel on the passenger seat toward the door or put their head or hands outside the vehicle.

**CAUTION**

**SRS airbag precautions**

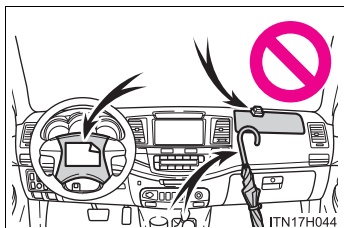

- Do not attach anything to or lean anything against areas such as the dashboard or steering wheel pad. These items can become projectiles when the SRS driver and front passenger airbags deploy.

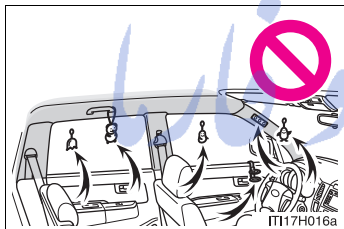

- Vehicles with SRS side and curtain shield airbags: Do not attach anything to areas such as a door, windshield glass, side door glass, front or rear pillar, roof side rail and assist grip.

- Vehicles with SRS side and curtain shield airbags: Do not hang coat hangers or other hard objects on the coat hooks. All of these items could become projectiles and may cause death or serious injury, should the SRS curtain shield airbags deploy.

- Vehicles with SRS side and curtain shield airbags: Do not use seat accessories which cover the parts where the SRS side airbags inflate as they may interfere with inflation of the SRS airbags. Such accessories may prevent the side airbags from activating correctly, disable the system or cause the side airbags to inflate accidentally, resulting in death or serious injury.



**⚠ CAUTION****■ SRS airbag precautions**

- Do not strike or apply significant levels of force to the area of the SRS airbag components.  
Doing so can cause the SRS airbags to malfunction.
- Do not touch any of the component parts immediately after the SRS airbags have deployed (inflated) as they may be hot.
- If breathing becomes difficult after the SRS airbags have deployed, open a door or window to allow fresh air in, or leave the vehicle if it is safe to do so. Wash off any residue as soon as possible to prevent skin irritation.
- If the areas where the SRS airbags are stored, such as the steering wheel pad and front and rear pillar garnishes, are damaged or cracked, have them replaced by any authorized Toyota dealer or repairer, or another duly qualified and equipped professional.

**■ Modification and disposal of SRS airbag system components**

Do not dispose of your vehicle or perform any of the following modifications without consulting any authorized Toyota dealer or repairer, or another duly qualified and equipped professional. The SRS airbags may malfunction or deploy (inflate) accidentally, causing death or serious injury.

- Installation, removal, disassembly and repair of the SRS airbags
- Repairs, modifications, removal or replacement of the steering wheel, instrument panel, dashboard, seats or seat upholstery, front, side and rear pillars or roof side rails
- Repairs or modifications of the front fender, front bumper, or side of the occupant compartment
- Installation of snow plows, winches, etc. to the front grille (bull bars or kangaroo bar etc.)
- Modifications to the vehicle's suspension system
- Installation of electronic devices such as RF-transmitter and CD players

1

Before driving

## 1-7. Safety information

### Child restraint systems

**Toyota strongly urges the use of child restraint systems.**

#### Points to remember

Studies have shown that installing a child restraint on a rear seat is much safer than installing one on the front passenger seat.

- Choose a child restraint system that suits your vehicle and is appropriate to the age and size of the child.
- For installation details, follow the instructions provided with the child restraint system.  
General installation instructions are provided in this manual.  
(→P. 134)
- If child restraint system regulations exist in the country where you reside, please contact any authorized Toyota dealer or repairer, or another duly qualified and equipped professional for the child restraint system installation.
- Toyota recommends that you use a child restraint system which conforms to the regulation ECE No.44.

FarmaSOS.com

### Types of child restraints

Child restraint systems are classified into the following 5 groups according to the regulation ECE No.44:

Group 0: Up to 10 kg (22 lb.) (0 - 9 months)

Group 0<sup>+</sup>: Up to 13 kg (28 lb.) (0 - 2 years)

Group I: 9 to 18 kg (20 to 39 lb.) (9 months - 4 years)

Group II: 15 to 25 kg (34 to 55 lb.) (4 years - 7 years)

Group III: 22 to 36 kg (49 to 79 lb.) (6 years - 12 years)

In this owner's manual, the following 3 types of popular child restraint systems that can be secured with the seat belts are explained:

1

Before driving

تلفن شبانه روزی: ۰۲۱-۸۸۶۲۰۸۵

FarmaSOS.com

1-7. Safety information

**Baby seat**

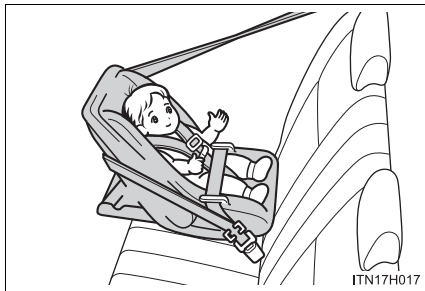

Equal to Group 0 and 0<sup>+</sup> of ECE  
No.44

**Child seat**



Equal to Group 0<sup>+</sup> and I of ECE  
No.44

**Junior seat**

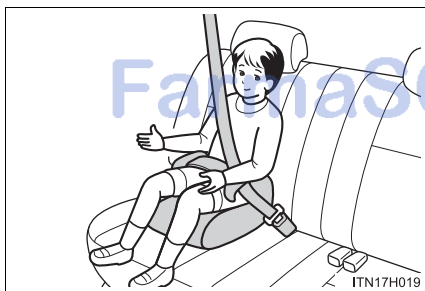

Equal to Group II and III of ECE  
No.44

### Child restraint system suitability for various seating positions

Information provided in the table shows your child restraint system suitability for various seating positions.

#### Single-cab models

Seating position  Mass groups	Front passenger seat				
	Separate seat		Bench seat		
	With airbag	Without airbag	Outside		Center
			With airbag	Without airbag	
0 Up to 10 kg (22 lb.) (0 - 9 months)	X Never put	L1	X Never put	L1	X
0 <sup>+</sup> Up to 13 kg (28 lb.) (0 - 2 years)	X Never put	L1	X Never put	L1	X
I 9 to 18 kg (20 to 39 lb.) (9 months - 4 years)	Rear- facing — X Never put	Rear- facing — X	Rear- facing — X Never put	Rear- facing — X	X
Forward-facing — L2					
II, III 15 to 36 kg (34 to 79 lb.) (4 - 12 years)	L3				X

1

Before driving

## 1-7. Safety information

Key of letters inserted in the above table:

L1: Suitable for “TOYOTA BABY SAFE (up to 13 kg [28 lb.])” approved for the use in this mass group.

L2: Suitable for “TOYOTA DUO<sup>+</sup> (9 to 18 kg [20 to 39 lb.])” approved for the use in this mass group.

L3: Suitable for “TOYOTA KID (15 to 36 kg [34 to 79 lb.])” approved for the use in this mass group.

X: Not suitable seat position for children in this mass group.

The child restraint system mentioned in the table may not be available outside of the EU area.

Other child restraint system which is different from the system mentioned in the table can be used, but the suitability of the systems must be carefully checked with the child restraint system manufacturer concerned and the seller of those seats.

تلفن شبانه روزی: ۰۲۱-۸۸۶۲۰۸۵

FarmaSOS.com

## Extra-cab models

Seating position Mass groups	Front passenger seat		Rear seat
	With airbag	Without airbag	
0 Up to 10 kg (22 lb.) (0 - 9 months)	X Never put	L1	X
0+ Up to 13 kg (28 lb.) (0 - 2 years)	X Never put	L1	X
I 9 to 18 kg (20 to 39 lb.) (9 months - 4 years)	Rear-facing — X Never put	Rear-facing — X	X
	Forward-facing — L2		
II, III 15 to 36 kg (34 to 79 lb.) (4 - 12 years)	L3		X

1

Before driving

FarmaSOS.com

## 1-7. Safety information

Key of letters inserted in the above table:

L1: Suitable for “TOYOTA BABY SAFE (up to 13 kg [28 lb.])” approved for the use in this mass group.

L2: Suitable for “TOYOTA DUO<sup>+</sup> (9 to 18 kg [20 to 39 lb.])” approved for the use in this mass group.

L3: Suitable for “TOYOTA KID (15 to 36 kg [34 to 79 lb.])” approved for the use in this mass group.

X: Not suitable seat position for children in this mass group.

The child restraint system mentioned in the table may not be available outside of the EU area.

Other child restraint system which is different from the system mentioned in the table can be used, but the suitability of the systems must be carefully checked with the child restraint system manufacturer concerned and the seller of those seats.

تلفن شبانه روزی: ۰۲۱-۸۸۶۲۰۸۵

FarmaSOS.com



**Double-cab models**

Seating position Mass groups	Front passenger seat		Rear seat	
	With airbag	Without airbag	Outside	Center
0 Up to 10 kg (22 lb.) (0 - 9 months)	X Never put	L1	U	X
0+ Up to 13 kg (28 lb.) (0 - 2 years)	X Never put	L1	U	X
I 9 to 18 kg (20 to 39 lb.) (9 months - 4 years)	Rear- facing — X Never put	Rear- facing — X	U	UF
	Forward-facing — L2			
II, III 15 to 36 kg (34 to 79 lb.) (4 - 12 years)	L3		U	UF

1

Before driving

Key of letters inserted in the above table:

U: Suitable for “universal” category child restraint system approved for the use in this mass group.

UF: Suitable for forward-facing “universal” category child restraint system approved for the use in this mass group.

L1: Suitable for “TOYOTA BABY SAFE (up to 13 kg [28 lb.])” approved for the use in this mass group.

L2: Suitable for “TOYOTA DUO<sup>+</sup> (9 to 18 kg [20 to 39 lb.])” approved for the use in this mass group.

L3: Suitable for “TOYOTA KID (15 to 36 kg [34 to 79 lb.])” approved for the use in this mass group.

X: Not suitable seat position for children in this mass group.

The child restraint system mentioned in the table may not be available outside of the EU area.

Other child restraint system which is different from the system mentioned in the table can be used, but the suitability of the systems must be carefully checked with the child restraint system manufacturer concerned and the seller of those seats.

FarmaSOS.com

### ■ When installing a child restraint system on the front passenger seat

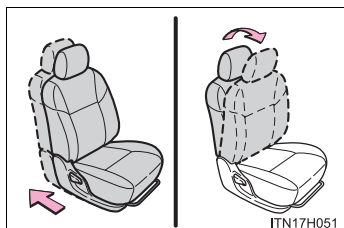

When you have to use a child restraint system on the front passenger seat, adjust the following:

- The seatback to the most upright position
- The seat cushion to the fully rearward position (if equipped)

### ■ Selecting an appropriate child restraint system

- Use a child restraint system appropriate for the child until the child becomes large enough to properly wear the vehicle's seat belt.
- If the child is too large for a child restraint system, sit the child on a rear seat and use the vehicle's seat belt. (→P. 78)

1

Before driving

تلفن شبانه روزی: ۰۲۱-۸۸۸۶۲۰۸۵

FarmaSOS.com

 CAUTION

■ **Using a child restraint system**

The use of a child restraint system not suitable for the vehicle may not properly secure the infant or child. It may result in death or serious injury (in the event of sudden braking or an accident).

■ **Child restraint precautions**

- For effective protection in automobile accidents and sudden stops, a child must be properly restrained, using a seat belt or child restraint system depending on the age and size of the child. Holding a child in your arms is not a substitute for a child restraint system. In an accident, the child can be crushed against the windshield, or between you and the vehicle's interior.
- Toyota strongly urges the use of a proper child restraint system that conforms to the size of the child, installed on the rear seat. According to accident statistics, the child is safer when properly restrained in the rear seat than in the front seat.
- Never install a rear-facing child restraint system on the front passenger seat.  
In the event of an accident, the force of the rapid inflation of the front passenger airbag can cause death or serious injury to the child if the rear-facing child restraint system is installed on the front passenger seat.
- A forward-facing child restraint system may be installed on the front passenger seat only when it is unavoidable. Adjust the seatback as upright as possible and always move the seat as far back as possible because the front passenger airbag could inflate with considerable speed and force. Otherwise, the child may be killed or seriously injured.

**⚠ CAUTION****■ Child restraint precautions**

- Vehicles with SRS side airbags and curtain shield airbags: Do not allow the child to lean his/her head or any part of his/her body against the door or the area of the seat, front and rear pillars or roof side rails from which the SRS side airbags or SRS curtain shield airbags deploy even if the child is seated in the child restraint system. It is dangerous if the SRS side airbags and curtain shield airbags inflate, and the impact could cause death or serious injury to the child.
- Make sure you have complied with all installation instructions provided by the child restraint manufacturer and that the system is properly secured. If it is not secured properly, it may cause death or serious injury to the child in the event of a sudden braking, sudden swerving or an accident.

**■ When children are in the vehicle**

Do not allow children to play with the seat belt. If the seat belt becomes twisted around a child's neck, it may lead to choking or other serious injuries that could result in death.

If this occurs and the buckle cannot be unfastened, scissors should be used to cut the belt.

**■ When the child restraint system is not in use**

- Keep the child restraint system properly secured on the seat even if it is not in use. Do not store the child restraint system unsecured in the passenger compartment.
- If it is necessary to detach the child restraint system, remove it from the vehicle. This will prevent it from injuring passengers in the event of a sudden braking, sudden swerving or an accident.

1

Before driving

## 1-7. Safety information

### Installing child restraints

Follow the child restraint system manufacturer's instructions. Firmly secure child restraints to the seats using a seat belt.

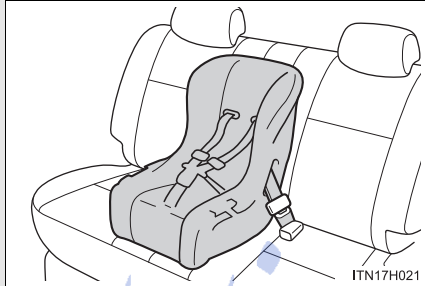

2-point type seat belt (if equipped)

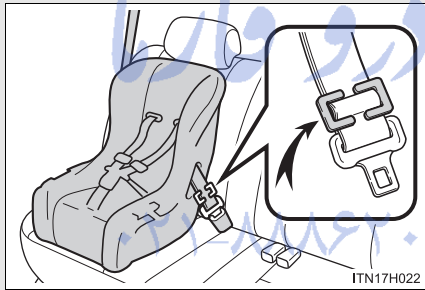

3-point type seat belts (An ELR belt requires a locking clip)

FarmaSOS.com

**Installing child restraints using a seat belt (2-point type seat belt)  
(if equipped)**

■ **Forward-facing — Child seat**

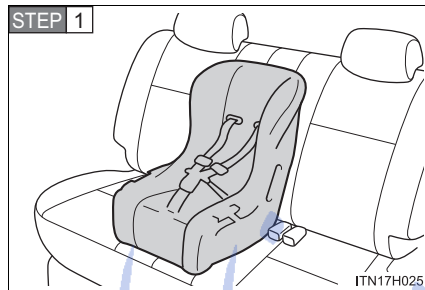

Place the child restraint system on the rear seat facing the front of the vehicle.

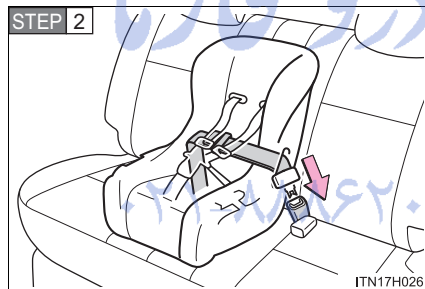

Run the seat belt through the child restraint system and insert the plate into the buckle. Make sure that the belt is not twisted.

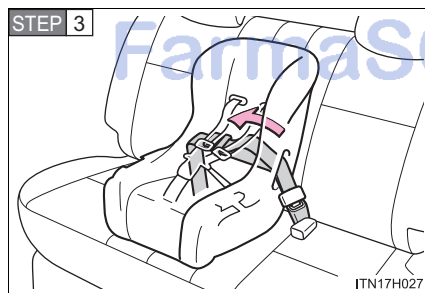

While pushing the child restraint system down into the seat, allow the belt to tighten by pulling its free end until the child restraint system is securely in place.

1

Before driving

### Installing child restraints using a seat belt (3-point type seat belt)

#### ■ Rear-facing — Baby seat/child seat

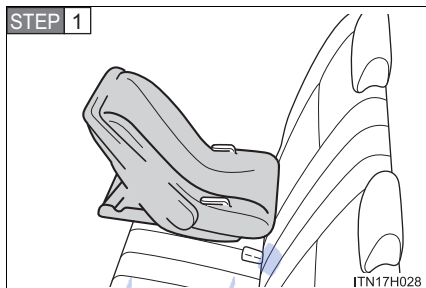

Place the child restraint system on the rear seat facing the rear of the vehicle.

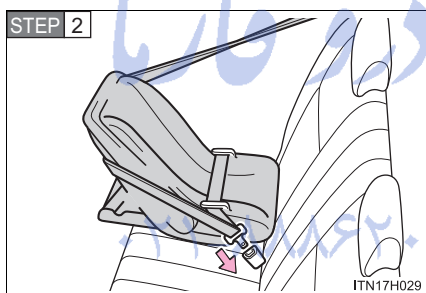

Run the seat belt through the child restraint system and insert the plate into the buckle. Make sure that the belt is not twisted. Keep the lap portion of the belt tight.

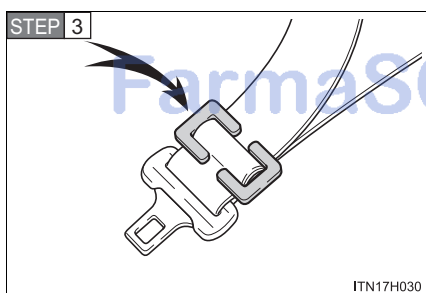

Install a locking clip near the plate of the lap and shoulder belt by inserting the lap and shoulder webbing through the recesses of the locking clip.



■ **Forward-facing — Child seat**

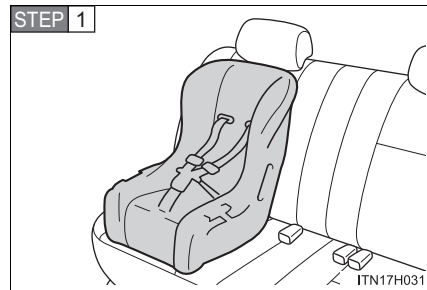

Place the child restraint system on the seat facing the front of the vehicle.

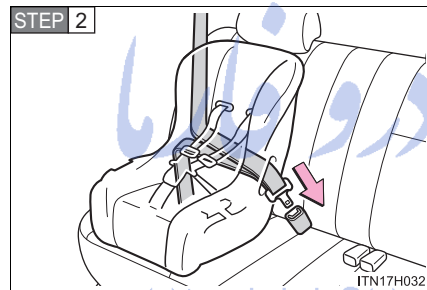

Run the seat belt through the child restraint system and insert the plate into the buckle. Make sure that the belt is not twisted. Keep the lap portion of the belt tight.

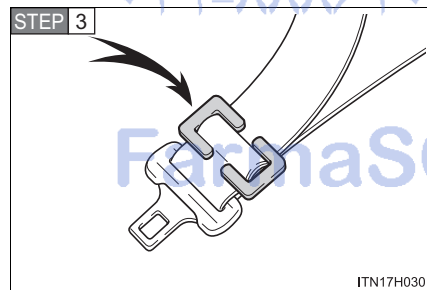

Install a locking clip near the plate of the lap and shoulder belt by inserting the lap and shoulder webbing through the recesses of the locking clip.

1

Before driving

■ Junior seat

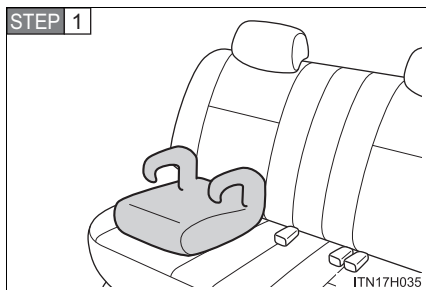

Place the child restraint system on the seat facing the front of the vehicle.

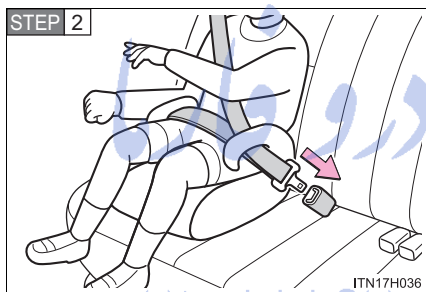

Sit the child in the child restraint system. Fit the seat belt to the child restraint system according to the manufacturer's instructions and insert the plate into the buckle. Make sure that the belt is not twisted.

Check that the shoulder belt is correctly positioned over the child's shoulder and that the lap belt is as low as possible.  
(→P. 78)

FarmaSOS.com

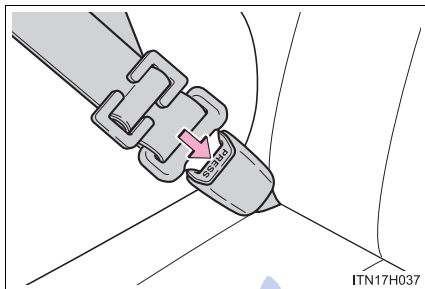
**Removing a child restraint installed with a seat belt**

2-point type seat belt (if equipped): Push the buckle release button.

3-point type seat belt: Push the buckle release button and fully retract the seat belt.

1

Before driving

■ **When installing a child restraint system in the seat with ELR belt**

You need a locking clip to install the child restraint system. Follow the instructions provided by the manufacturer of the system. If your child restraint system does not provide a locking clip, you can purchase the following item from any authorized Toyota dealer or repairer, or another duly qualified and equipped professional.

Locking clip for child restraint system  
(Part No. 73119-22010)

تلفن شبانه روزی: ۰۲۱-۸۸۴۲۰۸۵

FarmaSOS.com

**⚠ CAUTION**

■ **When installing a child restraint system**

Follow the directions given in the child restraint system installation manual and fix the child restraint system securely in place.

If the child restraint system is not correctly fixed in place, the child or other passengers may be seriously injured or even killed in the event of a sudden braking, sudden swerving or an accident.

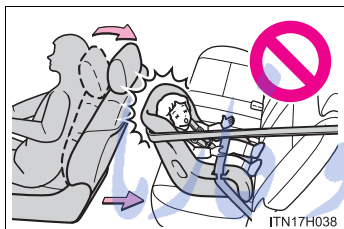

- Double-cab models: If the driver's seat interferes with the child restraint system and prevents it from being attached correctly, attach the child restraint system to the right-hand rear seat (left-hand drive vehicles) or the left-hand rear seat (right-hand drive vehicles).
- Double-cab models: Adjust the front passenger seat so that it does not interfere with the child restraint system.

تلفن شبانه روزی: ۰۲۱-۸۸۸۶۲۰۸۵

FarmaSOS.com

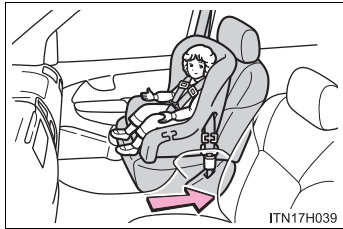
**⚠ CAUTION****■ When installing a child restraint system**

- Only put a forward-facing child restraint system on the front seat when unavoidable. When installing a forward-facing child restraint on the front passenger seat, move the seat as far back as possible (if equipped).

Failure to do so may result in death or serious injury if the airbags deploy (inflate).

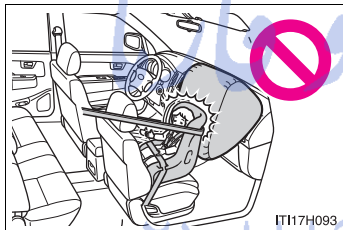

- Never use a rear-facing child restraint system on the front passenger seat.

The force of the rapid inflation of the front passenger airbag can cause death or serious injury to children in the event of an accident.

1

Before driving

FarmaSOS.com

**⚠ CAUTION**

**■ When installing a child restraint system**

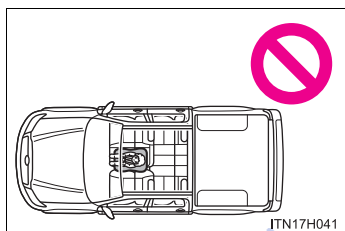

- Vehicles with front bench seat: Do not install a child restraint system in the center position. This seat position is not designed to hold a child restraint system.

If used in the center position, depending on its type, the child restraint system may interfere with the proper usage of the driver's and front passenger's seat belts. It may also hamper your driving.

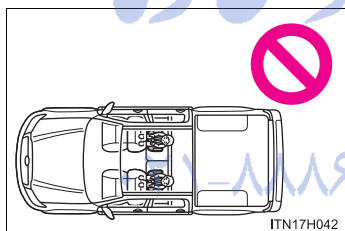

- Extra-cab models: Do not install a child restraint system on the rear seat. These seats are not designed to hold a child restraint system.

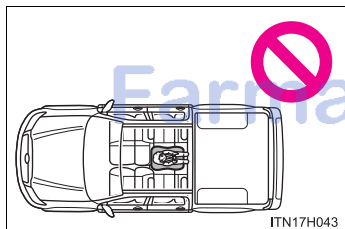

- Double-cab models: Do not install a rear-facing child (convertible) seat in the rear center position. This seat position is not designed to hold a rear-facing child (convertible) seat. Otherwise, the child or front seat occupant(s) may be killed or seriously injured in the event of sudden braking, sudden swerving or an accident.

**⚠ CAUTION****■ When installing a child restraint system**

- If child restraint system regulations exist in the country where you reside, please contact any authorized Toyota dealer or repairer, or another duly qualified and equipped professional for the child restraint system installation.
- When a junior seat is installed, always ensure that the shoulder belt is positioned across the center of the child's shoulder. The belt should be kept away from the child's neck, but not so that it could fall off the child's shoulder. Failing to do so may result in death or serious injury in the event of a sudden braking, sudden swerving or an accident.
- Ensure that the belt and plate are securely locked and the seat belt is not twisted.
- Push and pull the child restraint system from side to side and forward to be sure it is secure.
- After securing a child restraint system, never adjust the seat.
- Follow all installation instructions provided by the child restraint system manufacturer.

1

Before driving

امداد خودرو فارما  
 تلفن شبانه روزی: ۰۸۵ + ۸۸۶۲ - ۲۱

FarmaSOS.com

امداد خودرو فارما

تلفن شبانه روزی: ۰۲۱-۸۸۸۶۲۰۸۵

**FarmaSOS.com**



**2-1. Driving procedures**

Driving the vehicle ..... 146  
Engine (ignition) switch..... 162  
Automatic transmission .... 166  
Manual transmission..... 170  
Turn signal lever ..... 173  
Parking brake ..... 174  
Horn ..... 175

**2-2. Instrument cluster**

Gauges and meters ..... 176  
Indicators and warning lights ..... 180  
Multi-information display ..... 185

**2-3. Operating the lights and wipers**

Headlight switch..... 191  
Fog light switch ..... 195  
Windshield wipers and washer ..... 199  
Headlight cleaner switch... 201

**2-4. Using other driving systems**

Cruise control..... 202  
Rear view monitor system ..... 207  
Four-wheel drive system... 212  
Rear differential lock system ..... 217  
Driving assist systems ..... 221  
DPF (Diesel Particulate Filter) system ..... 227

**2-5. Driving information**

Cargo and luggage ..... 232  
Winter driving tips ..... 235  
Trailer towing ..... 239

## 2-1. Driving procedures

### Driving the vehicle

The following procedures should be observed to ensure safe driving:

#### ■ Starting the engine

→P. 162

#### ■ Driving

##### Automatic transmission

**STEP 1** With the brake pedal depressed, shift the shift lever to D.  
(→P. 166)

**STEP 2** Release the parking brake. (→P. 174)

**STEP 3** Gradually release the brake pedal and gently depress the accelerator pedal to accelerate the vehicle.

##### Manual transmission

**STEP 1** While depressing the clutch pedal, shift the shift lever to 1.  
(→P. 170)

**STEP 2** Release the parking brake. (→P. 174)

**STEP 3** Gradually release the clutch pedal. At the same time, gently depress the accelerator pedal to accelerate the vehicle.

FarmaSOS.com

## ■ Stopping

### Automatic transmission

**STEP 1** With the shift lever in D, depress the brake pedal.

**STEP 2** If necessary, set the parking brake.

If the vehicle is to be stopped for an extended period of time, shift the shift lever to P or N. (→P. 166)

### Manual transmission

**STEP 1** While depressing the clutch pedal, depress the brake pedal.

**STEP 2** If necessary, set the parking brake.

If the vehicle is to be stopped for an extended period of time, shift the shift lever to N. (→P. 170)

## ■ Parking the vehicle

### Automatic transmission

**STEP 1** With the shift lever in D, depress the brake pedal.

**STEP 2** Set the parking brake. (→P. 174) *تلفن شبانه روزی: ۰۲۱-۸۸۵۲۰۰۰۰*

**STEP 3** Shift the shift lever to P. (→P. 166)

If parking on a hill, block the wheels as needed.

**STEP 4** Turn the engine switch to the "LOCK" position to stop the engine.

**STEP 5** Lock the door, making sure that you have the key on your person.

### Manual transmission

- STEP 1** While depressing the clutch pedal, depress the brake pedal.
- STEP 2** Set the parking brake. (→P. 174)
- STEP 3** Shift the shift lever to N. (→P. 170)  
If parking on a hill, shift the shift lever to 1 or R and block the wheels as needed.
- STEP 4** Turn the engine switch to the “LOCK” position to stop the engine.
- STEP 5** Lock the door, making sure that you have the key on your person.

### Starting off on a steep uphill

#### Automatic transmission

- STEP 1** Make sure that the parking brake is set and shift the shift lever to D.
- STEP 2** Gently depress the accelerator pedal.
- STEP 3** Release the parking brake.

#### Manual transmission

- STEP 1** With the parking brake firmly set and the clutch pedal fully depressed, shift the shift lever to 1.
- STEP 2** Lightly depress the accelerator pedal at the same time as gradually releasing the clutch pedal.
- STEP 3** Release the parking brake.

**■ Driving in the rain**

- Drive carefully when it is raining, because visibility will be reduced, the windows may become fogged-up, and the road will be slippery.
- Drive carefully when it starts to rain, because the road surface will be especially slippery.
- Refrain from high speeds when driving on an expressway in the rain, because there may be a layer of water between the tires and the road surface, preventing the steering and brakes from operating properly.

**■ Breaking in your new Toyota**

To extend the life of the vehicle, observing the following precautions is recommended:

- For the first 300 km (200 miles):  
Avoid sudden stops.
- For the first 800 km (500 miles):  
Do not tow a trailer.
- For the first 1000 km (600 miles):
  - Do not drive at extremely high speeds.
  - Avoid sudden acceleration.
  - Do not drive continuously in the low gears.
  - Do not drive at a constant speed for extended periods.
  - Do not drive slowly with the manual transmission in a high gear.

2

When driving

FarmaSOS.com

## 2-1. Driving procedures

### ■ Idling time before stopping the engine

To prevent damage to the turbocharger, allow the engine to idle immediately after high-speed driving or driving up a hill.

Driving condition		Idling time
Normal city driving		Not necessary
High-speed driving	Constant speed of approx. 80 km/h (50 mph)	Approximately 20 seconds
	Constant speed of approx. 100 km/h (62 mph)	Approximately 1 minute
Steep hill driving or continuous driving at 100 km/h (62 mph) or more (race track driving etc.)		Approximately 2 minutes

### ■ Operating your vehicle in a foreign country

Comply with the relevant vehicle registration laws and confirm the availability of the correct fuel. (→P. 609)

تلفن شبانه روزی: ۰۲۱-۸۸۶۲۰۸۵

FarmaSOS.com

**⚠ CAUTION****■ When starting the vehicle**

On vehicles with automatic transmission, always keep your foot on the brake pedal while stopped with the engine running. This prevents the vehicle from creeping.

**■ When driving the vehicle**

- Do not drive if you are unfamiliar with the location of the brake and accelerator pedals to avoid depressing the wrong pedal.
  - Accidentally depressing the accelerator pedal instead of the brake pedal will result in sudden acceleration that may lead to an accident that could result in death or serious injury.
  - When backing up, you may twist your body around, leading to a difficulty in operating the pedals. Make sure to operate the pedals properly.
  - Make sure to keep a correct driving posture even when moving the vehicle only slightly. This allows you to depress the brake and accelerator pedals properly.
  - Depress the brake pedal using your right foot. Depressing the brake pedal using your left foot may delay response in an emergency, resulting in an accident.
- Do not drive the vehicle over or stop the vehicle near flammable materials. The exhaust system and exhaust gases can be extremely hot. These hot parts may cause a fire if there is any flammable material nearby.

2

When driving

FarmaSOS.com

 CAUTION

- On vehicles with automatic transmission, do not let the vehicle roll backwards while the shift lever is in a driving position, or roll forward while the shift lever is in R.  
Doing so may cause the engine to stall or lead to poor brake and steering performance, resulting in an accident or damage to the vehicle.
- If the smell of exhaust is noticed inside the vehicle, open the windows and check that the back window (vehicles with sliding type) is closed. Large amounts of exhaust in the vehicle can cause driver drowsiness and an accident, resulting in death or a serious health hazard. Have the vehicle inspected by any authorized Toyota dealer or repairer, or another duly qualified and equipped professional immediately.
- On vehicles with automatic transmission, do not shift the shift lever to P while the vehicle is moving.  
Doing so can damage the transmission and may result in a loss of vehicle control.
- Do not shift the shift lever to R while the vehicle is moving forward.  
Doing so can damage the transmission and may result in a loss of vehicle control.
- Do not shift the shift lever to D (vehicles with automatic transmission) or 1 (vehicles with manual transmission) while the vehicle is moving backward.  
Doing so can damage to the transmission and may result in a loss of vehicle control.
- Moving the shift lever to N while the vehicle is moving will disengage the engine from the transmission. Engine braking is not available when N is selected.



**⚠ CAUTION**

- During normal driving, do not turn off the engine. Turning the engine off while driving will not cause loss of steering or braking control, but the power assist to these systems will be lost. This will make it more difficult to steer and brake, so you should pull over and stop the vehicle as soon as it is safe to do so.  
However, in the event of an emergency, such as if it becomes impossible to stop the vehicle in the normal way: →P. 598
- Use engine braking (downshift) to maintain a safe speed when driving down a steep hill.  
Using the brakes continuously may cause the brakes to overheat and lose effectiveness. (→P. 167)
- Do not adjust the positions of the steering wheel, the seat, or the inside or outside rear view mirrors while driving.  
Doing so may result in a loss of vehicle control that can cause accidents, resulting in death or serious injury.
- Always check that all passengers' arms, heads or other parts of their body are not outside the vehicle, as this may result in death or serious injury.
- On vehicles with manual transmission, do not operate the clutch halfway for a long period of time unless it is necessary. Doing so could not only speed up clutch wear, but could also damage the clutch or even cause a fatal accident such as vehicle fire.

2

When driving

FarmaSOS.com

 CAUTION

■ **When driving on slippery road surfaces**

- Sudden braking, acceleration and steering may cause tire slippage and reduce your ability to control the vehicle, resulting in an accident.
- Sudden changes in engine speed, such as engine braking caused by up-shifting and down-shifting, may cause the vehicle to skid, resulting in an accident.
- After driving through a puddle, lightly depress the brake pedal to make sure that the brakes are functioning properly. Wet brake pads may prevent the brakes from functioning properly. If the brakes on only one side are wet and not functioning properly, steering control may be affected, resulting in an accident.

■ **When shifting the shift lever**

On vehicles with automatic transmission, be careful not to shift the shift lever with the accelerator pedal depressed. Shifting the shift lever to a gear other than P or N may lead to unexpected rapid acceleration of the vehicle that may cause an accident and result in death or serious injury.

■ **If you hear a squealing or scraping noise (brake pad wear indicators)**

Have the brake pads checked and replaced by any authorized Toyota dealer or repairer, or another duly qualified and equipped professional as soon as possible.

Rotor damage may result if the pads are not replaced when needed.

It is dangerous to drive the vehicle when the wear limits of the brake pads and/or those of the brake discs are exceeded.

**⚠ CAUTION****■ When the vehicle is stopped**

- Do not race the engine.  
If the vehicle is in any gear other than P (vehicles with automatic transmission only) or N, the vehicle may accelerate suddenly and unexpectedly, causing an accident.
- Do not leave the vehicle with the engine running for a long time.  
If such a situation cannot be avoided, park the vehicle in an open space and check that exhaust fumes do not enter the vehicle interior.
- On vehicles with automatic transmission, in order to prevent accidents due to the vehicle rolling away, always keep depressing the brake pedal while the engine is running, and apply the parking brake as necessary.
- If the vehicle is stopped on an incline, in order to prevent accidents caused by the vehicle rolling forward or backward, always depress the brake pedal and securely apply the parking brake as needed.
- Avoid revving or racing the engine.  
Running the engine at high speed while the vehicle is stopped may cause the exhaust system to overheat, which could result in a fire if combustible material is nearby.

2

When driving

FarmaSOS.com

 CAUTION

■ **When the vehicle is parked**

- Do not leave glasses, cigarette lighters, spray cans, or soft drink cans in the vehicle when it is in the sun.  
Doing so may result in the following:
  - Gas may leak from a cigarette lighter or spray can, and may lead to a fire.
  - The temperature inside the vehicle may cause the plastic lenses and plastic material of glasses to deform or crack.
  - Soft drink cans may fracture, causing the contents to spray over the interior of the vehicle, and may also cause a short circuit in the vehicle's electrical components.
- Do not leave cigarette lighters in the vehicle. If a cigarette lighter is in a place such as the glove box or on the floor, it may be lit accidentally when luggage is loaded or the seat is adjusted, causing a fire.
- Do not attach adhesive discs to the windshield or windows. Do not place containers such as air fresheners on the instrument panel or dashboard. Adhesive discs or containers may act as lenses, causing a fire in the vehicle.
- Do not leave a door or window open if the curved glass is coated with a metallized film such as a silver-colored one. Reflected sunlight may cause the glass to act as a lens, causing a fire.
- Always apply the parking brake, shift the shift lever to P (vehicles with automatic transmission only), stop the engine and lock the vehicle.  
Do not leave the vehicle unattended while the engine is running.

**⚠ CAUTION**

- Do not touch the exhaust pipes while the engine is running or immediately after turning the engine off.  
Doing so may cause burns.
- Do not leave the engine running in an area with snow build-up, or where it is snowing. If snowbanks build up around the vehicle while the engine is running, exhaust gases may collect and enter the vehicle. This may lead to death or a serious health hazard.

**■ Exhaust gases**

Exhaust gases include harmful carbon monoxide (CO), which is colorless and odorless. Inhaling exhaust gases may lead to death or a serious health hazard.

- If the vehicle is in a poorly ventilated area, stop the engine. In a closed area, such as a garage, exhaust gases may collect and enter the vehicle. This may lead to death or a serious health hazard.
- The exhaust system should be checked occasionally. If there is a hole or crack caused by corrosion, damage to a joint or abnormal exhaust noise, be sure to have the vehicle inspected and repaired by any authorized Toyota dealer or repairer, or another duly qualified and equipped professional. Failure to do so may allow exhaust gases to enter the vehicle, resulting in death or a serious health hazard.
- Toyota does not recommend occupying the rear cargo area when it is fitted with a slide-in camper, camper shell or other type cover while the engine is running. This caution applies to both driving and stopped or parked situations with the engine running. Particular care should be taken to prevent exhaust gases from entering camper bodies, trailers or other enclosures on or around your vehicle. If exhaust fumes are detected, open all windows and thoroughly ventilate the area.

2

When driving

 CAUTION

■ **When taking a nap in the vehicle**

Always turn the engine off. Otherwise, if you accidentally move the shift lever or depress the accelerator pedal, this could cause an accident or fire due to engine overheating. Additionally, if the vehicle is parked in a poorly ventilated area, exhaust gases may collect and enter the vehicle, leading to death or a serious health hazard.

■ **When braking**

- When the brakes are wet, drive more cautiously.  
Braking distance increases when the brakes are wet, and this may cause one side of the vehicle to brake differently than the other side. Also, the parking brake may not securely hold the vehicle.
- If the power brake assist function does not operate, do not follow other vehicles closely and avoid hills or sharp turns that require braking. In this case, braking is still possible, but the brake pedal should be depressed more firmly than usual. Also, the braking distance will increase.
- Do not pump the brake pedal if the engine stalls.  
Each push on the brake pedal uses up the reserve for the power-assisted brakes.
- The brake system consists of 2 individual hydraulic systems: If one of the systems fails, the other will still operate. In this case, the brake pedal should be depressed more firmly than usual and the braking distance will increase.  
If this happens, do not continue to drive the vehicle. Have your brakes fixed immediately.

 NOTICE

**■ When driving the vehicle**

- Do not depress the accelerator and brake pedals at the same time during driving, as this may restrain driving torque.
- On vehicles with automatic transmission, do not use the accelerator pedal or depress the accelerator and brake pedals at the same time to hold the vehicle on a hill.
- On vehicles with manual transmission, do not shift gears unless the clutch pedal is fully depressed. After shifting, do not release the clutch pedal abruptly. Doing so may damage the clutch, transmission and gears.
- On vehicles with manual transmission, observe the following to prevent the clutch from being damaged.
  - Do not rest your foot on the clutch pedal while driving. Doing so may cause clutch trouble.
  - Do not use any gears other than the 1st gear when starting off and moving forward. Doing so may damage the clutch.
  - Do not use the clutch to hold the vehicle when stopping on an uphill grade. Doing so may damage the clutch.
- On vehicles with manual transmission, do not shift the shift lever to R when the vehicle is still moving. Doing so may damage the clutch, transmission and gears.
- On vehicles with manual transmission, if you cannot accelerate the vehicle even when the clutch is engaged and the accelerator pedal is depressed, this may mean that the clutch is slipping, and the vehicle may be rendered undriveable. Have any authorized Toyota dealer or repairer, or another duly qualified and equipped professional inspect the vehicle as soon as possible.

2

When driving

 NOTICE

■ **When parking the vehicle**

On vehicles with automatic transmission, always shift the shift lever to P. Failure to do so may cause the vehicle to move or the vehicle may accelerate suddenly if the accelerator pedal is accidentally depressed.

■ **Avoiding damage to vehicle parts**

- Do not turn the steering wheel fully in either direction and hold it there for an extended period of time.  
Doing so may damage the power steering pump.
- When driving over bumps in the road, drive as slowly as possible to avoid damaging the wheels, underside of the vehicle, etc.
- Make sure to idle the engine immediately after high-speed driving or hill climbing. Stop the engine only after the turbocharger has cooled down.  
Failure to do so may cause damage to the turbocharger.

■ **If you get a flat tire while driving**

A flat or damaged tire may cause the following situations. Hold the steering wheel firmly and gradually depress the brake pedal to slow down the vehicle.

- It may be difficult to control your vehicle. *تلفن شبانه روزی: ۰۲۱-۸۸۸۳۰۸۵*
- The vehicle will make abnormal sounds or vibrations.
- The vehicle will lean abnormally.

Information on what to do in case of a flat tire. (→P. 565)



 NOTICE**■ When encountering flooded roads**

Do not drive on a road that has flooded after heavy rain etc. Doing so may cause the following serious damage to the vehicle:

- Engine stalling
- Short in electrical components
- Engine damage caused by water immersion

In the event that you drive on a flooded road and the vehicle is flooded, be sure to have any authorized Toyota dealer or repairer, or another duly qualified and equipped professional check the following:

- Brake function
- Changes in quantity and quality of oil and fluid used for the engine, transmission, transfer (4WD models), differential, etc.
- Lubricant condition for the propeller shaft, bearings and suspension joints (where possible), and the function of all joints, bearings, etc.

2

When driving

تلفن شبانه روزی: ۰۲۱-۸۸۶۲۰۸۵

FarmaSOS.com

## 2-1. Driving procedures

### Engine (ignition) switch

#### ■ Starting the engine

##### Automatic transmission

**STEP 1** Check that the parking brake is set.

**STEP 2** Check that the shift lever is set in P.

**STEP 3** Firmly depress the brake pedal.

**STEP 4** Turn the engine switch to the “ON” position.

The  indicator turns on.

**STEP 5** After the  indicator light goes out, turn the engine switch to the “START” position to start the engine.

##### Manual transmission

**STEP 1** Check that the parking brake is set.

**STEP 2** Check that the shift lever is set in N.

**STEP 3** Firmly depress the clutch pedal.

**STEP 4** Turn the engine switch to the “ON” position.

The  indicator turns on.

**STEP 5** After the  indicator light goes out, turn the engine switch to the “START” position to start the engine.

FarmaSOS.com

### ■ Changing the engine switch positions

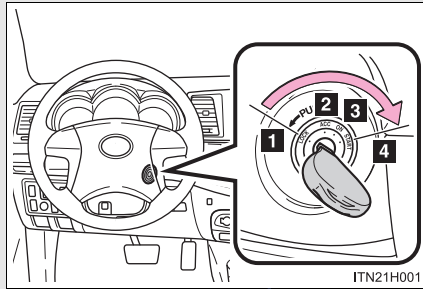

#### 1 "LOCK"

The steering wheel is locked and the key can be removed. (Vehicles with automatic transmission: The key can be removed only when the shift lever is in P.)

#### 2 "ACC"

Some electrical components such as the audio system can be used.

#### 3 "ON"

All electrical components can be used.

#### 4 "START"

For starting the engine.

2

When driving

FarmaSOS.com

■ Turning the key from “ACC” to “LOCK”

**STEP 1** Shift the shift lever to P (automatic transmission) or N (manual transmission). (→P. 166, 170)

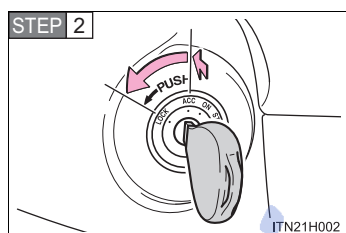

Push in the key and turn to the “LOCK” position.

■ If the engine does not start

The engine immobilizer system may not have been deactivated. (→P. 102)

■ When the steering lock cannot be released

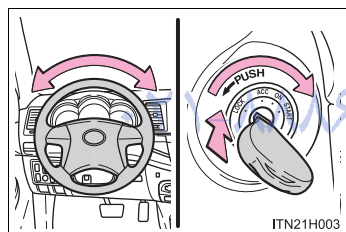

When starting the engine, the engine switch may seem stuck in the “LOCK” position. To free it, turn the key while turning the steering wheel slightly left and right.

■ Key reminder function

A buzzer sounds if the driver’s door is opened while the engine switch is in the “LOCK” or “ACC” position to remind you to remove the key.

**⚠ CAUTION****■ When starting the engine**

Always start the engine while sitting in the driver's seat. Do not depress the accelerator pedal while starting the engine under any circumstances. Doing so may cause an accident resulting in death or serious injury.

**■ Caution when driving**

Do not turn the engine switch to the "LOCK" position while driving. If in an emergency, you must turn the engine off while the vehicle is moving, turn the engine switch only to the "ACC" position to stop the engine. An accident may result if the engine is stopped while driving.

**⚠ NOTICE****■ To prevent battery discharge**

Do not leave the engine switch in the "ACC" or "ON" position for long periods of time without the engine running.

**■ When starting the engine**

- Do not crank the engine for more than 30 seconds at a time. This may overheat the starter and wiring system.
- Do not race a cold engine.
- If the engine becomes difficult to start or stalls frequently, have the engine checked immediately.

## 2-1. Driving procedures

### Automatic transmission\*

Select a shift position appropriate for the driving conditions.

#### ■ Shifting the shift lever

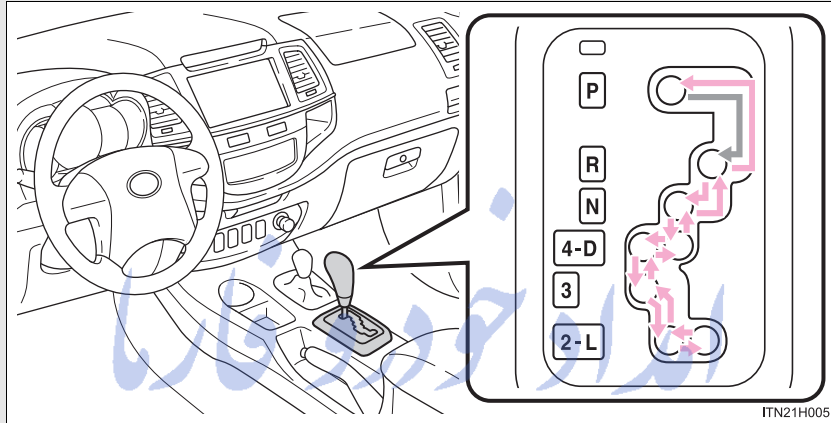

← While the engine switch is in the “ON” position, move the shift lever with the brake pedal depressed.

When shifting the shift lever between P and D, make sure that the vehicle is completely stopped.

FarmaSOS.com

\*: If equipped

### ■ Shift position purpose

Shift position	Function
P	Parking the vehicle/starting the engine
R	Reversing
N	Neutral
D	Normal driving*
4	Position for engine braking
3	Position for more powerful engine braking
2	Position for more powerful engine braking
L	Position for maximum engine braking

\*: To improve fuel efficiency and reduce noises, set the shift lever in the D position for normal driving.

2

When driving

تلفن شبانه روزی: ۰۲۱-۸۸۶۲۰۸۵

FarmaSOS.com

### ■ Downshift restriction

The maximum allowable speeds are as follows.

Downshifting	Maximum speed km/h (mph)			
	SR grade*		DLX grade*	
	Front drive control lever in H2 or H4	Front drive control lever in L4	Front drive control lever in H2 or H4	Front drive control lever in L4
D → 4	140 (87)	-	145 (90)	-
4 → 3	100 (62)	35 (22)	105 (65)	40 (25)
3 → 2	65 (40)	25 (16)	70 (43)	25 (16)
2 → L	20 (12)	5 (3)	20 (12)	5 (3)

\*: See "Checking your vehicle's model" if you are not sure of which model your vehicle is. (→P. 41)

### ■ AI-SHIFT

AI-SHIFT automatically selects the optimal gear according to driver performance and driving conditions.

AI-SHIFT automatically operates when the shift lever is in the D position.

The engine speed may remain high after releasing the accelerator pedal.

This does not indicate a malfunction.

### ■ When driving with the cruise control system (If equipped)

Engine braking will not occur when downshifting from D to 4. (→P. 202)

### ■ If the shift lever cannot be shifted from P

→P. 585



 CAUTION

■ **When driving on slippery road surfaces**

Do not accelerate or shift gears suddenly.  
Sudden changes in engine braking may cause the vehicle to spin or skid, resulting in an accident.

2

When driving

امداد خودرو فارما

تلفن شبانه روزی: ۰۲۱-۸۸۸۶۲۰۸۵

FarmaSOS.com

## 2-1. Driving procedures

### Manual transmission\*

#### ■ Shifting the shift lever

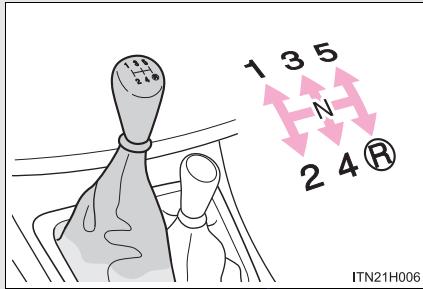

Fully depress the clutch pedal before operating the shift lever, and then release it slowly.

If it is difficult to shift in reverse, shift the shift lever to N, release the clutch pedal momentarily, and then try again.

امداد خودرو فارما

تلفن شبانه روزی: ۰۲۱-۸۸۸۶۲۰۸۵

FarmaSOS.com

\*: If equipped

### ■ Maximum downshifting speeds

Observe the downshifting speeds in the following table to prevent over-revving the engine.

#### 4WD models

Shift position	Front drive control lever	Maximum speed km/h (mph)		
		1KD-FTV engine	2KD-FTV engine	
			For Russia and Ukraine	Except for Russia and Ukraine
1	H2, H4	39 (24) <sup>*1</sup> 38 (24) <sup>*2</sup>	36 (22) <sup>*1</sup> 35 (22) <sup>*2, 3</sup>	38 (24) <sup>*1</sup> 37 (23) <sup>*2, 3</sup>
	L4	15 (9)	14 (9)	15 (9) <sup>*1</sup> 14 (9) <sup>*2, 3</sup>
2	H2, H4	73 (45) <sup>*1</sup> 71 (44) <sup>*2</sup>	67 (42) <sup>*1</sup> 65 (40) <sup>*2, 3</sup>	70 (43) <sup>*1</sup> 68 (42) <sup>*2, 3</sup>
	L4	29 (18) <sup>*1</sup> 28 (17) <sup>*2</sup>	26 (16) <sup>*1</sup> 25 (16) <sup>*2, 3</sup>	27 (17) <sup>*1, 2</sup> 26 (16) <sup>*3</sup>
3	H2, H4	119 (74) <sup>*1</sup> 115 (71) <sup>*2</sup>	109 (68) <sup>*1</sup> 105 (65) <sup>*2, 3</sup>	114 (71) <sup>*1</sup> 110 (68) <sup>*2, 3</sup>
	L4	46 (29) <sup>*1</sup> 45 (28) <sup>*2</sup>	42 (26) <sup>*1</sup> 41 (25) <sup>*2, 3</sup>	45 (28) <sup>*1</sup> 43 (27) <sup>*2, 3</sup>
4	H2, H4	170 (106) <sup>*1</sup> 165 (103) <sup>*2</sup>	156 (97) <sup>*1</sup> 151 (94) <sup>*2, 3</sup>	164 (102) <sup>*1</sup> 158 (98) <sup>*2, 3</sup>
	L4	67 (42) <sup>*1</sup> 64 (40) <sup>*2</sup>	61 (38) <sup>*1</sup> 59 (37) <sup>*2, 3</sup>	64 (40) <sup>*1</sup> 62 (39) <sup>*2, 3</sup>

\*1: With 265/65R17 tires

\*2: With 255/70R15C tires

\*3: With 205R16C tires

## 2-1. Driving procedures

### Pre Runner

Shift position	Maximum speed km/h (mph)	
	With 265/65R17 tires	With 255/70R15C and 205R16C tires
1	38 (24)	37 (23)
2	70 (43)	68 (42)
3	114 (71)	110 (68)
4	164 (102)	158 (98)

امداد خودرو فارما

تلفن شبانه روزی: ۰۲۱-۸۸۸۶۲۰۸۵

FarmaSOS.com

## 2-1. Driving procedures

### Turn signal lever

The turn signal lever can be used to show the following intentions of the driver:

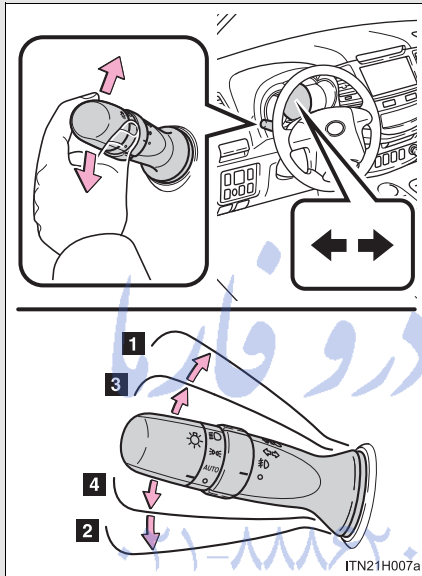

- 1 Right turn
- 2 Left turn
- 3 Lane change to the right (push and hold the lever partway)

The right hand signals will flash until you release the lever.

- 4 Lane change to the left (push and hold the lever partway)

The left hand signals will flash until you release the lever.

2

When driving

#### ■ Turn signals can be operated when

The engine switch is in the "ON" position.

#### ■ If the indicator flashes faster than usual

Check that a light bulb in the front or rear turn signal lights has not burned out.

## 2-1. Driving procedures

### Parking brake

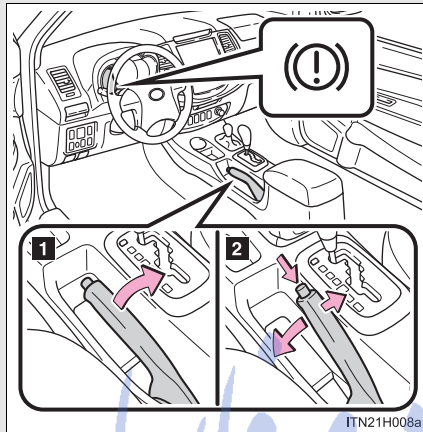

- 1 To set the parking brake, fully pull the parking brake lever while depressing the brake pedal.

At this time, the brake system warning light will come on.

- 2 To release the parking brake, slightly raise the lever and lower it in completely while pressing the button.

At this time, the brake system warning light will go off.

#### ■ Usage in winter time

See "Winter driving tips" for parking brake usage in winter time. (→P. 235)

#### ⚠ NOTICE

##### ■ Before driving

Fully release the parking brake.

Driving the vehicle with the parking brake set will lead to brake components overheating, which may affect braking performance and increase brake wear.

## 2-1. Driving procedures

### Horn

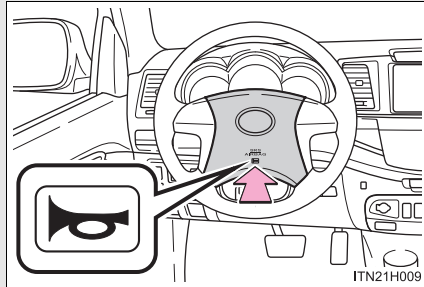

To sound the horn, press on or close to the  mark.

2

When driving

#### ■ After adjusting the steering wheel

Make sure that the steering wheel is securely locked.  
The horn may not sound if the steering wheel is not securely locked.  
(→P. 85)

تلفن شبانه روزی: ۰۲۱-۸۸۶۲۰۸۵

FarmaSOS.com

## 2-2. Instrument cluster Gauges and meters

### Non-Optitron type meters

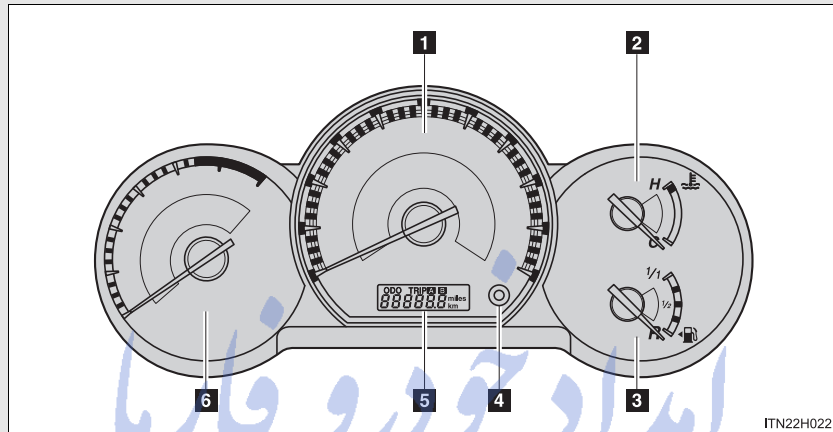

### Optitron type meters

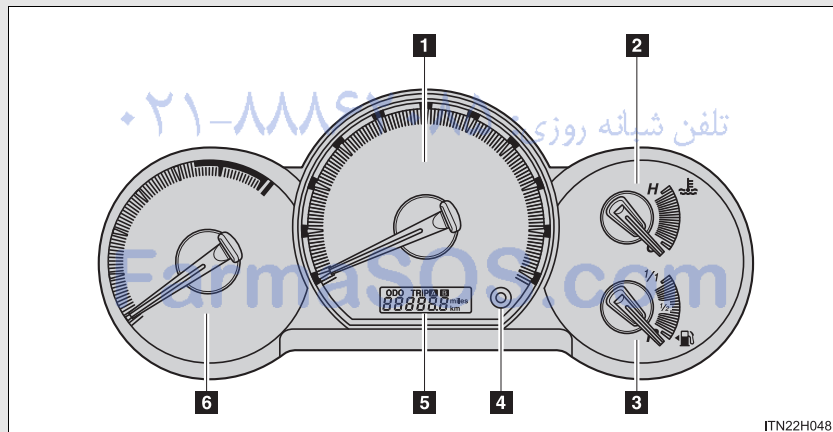



**1** Speedometer

Displays the vehicle speed.

**2** Engine coolant temperature gauge

Displays the engine coolant temperature.

**3** Fuel gauge

Displays the quantity of fuel remaining in the tank.

**4** Odometer/trip meter display change button

→P. 178

**5** Odometer and trip meter display

Odometer: Displays the total distance the vehicle has been driven.

Trip meter: Displays the distance the vehicle has been driven since the meter was last reset. Trip meters A and B can be used to record and display different distances independently.

**6** Tachometer

Displays the engine speed in revolutions per minute.

2

When driving

تلفن شبانه روزی: ۰۲۱-۸۸۸۶۲۰۸۵

FarmaSOS.com

### Changing the display

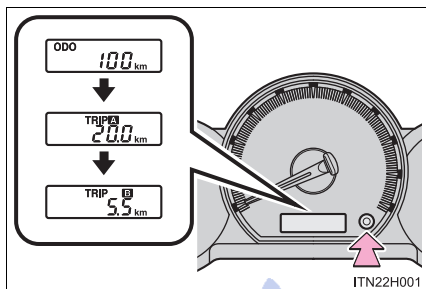

Switches between odometer and trip meter displays. When the trip meter is displayed, pressing and holding the button will reset the trip meter.

The units may differ depending on the target region.

### Instrument panel light control (if equipped)

The brightness of the instrument panel lights can be adjusted by turning the knob.

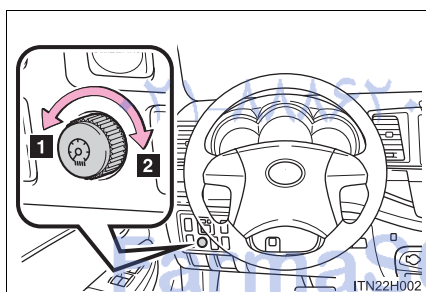

**1** Darker

**2** Brighter

■ **The meters illuminate when**

**Vehicles without optitron type meter**

The front position lights is turned on.

**Vehicles with optitron type meter**

The engine switch is in the "ON" position.

■ **The odometer and trip meter display illuminate when**

The engine switch is in the "ON" position.

■ **The brightness of the instrument panel lights**

When the headlight switch is turned to on, the brightness will be reduced slightly unless the control dial is turned fully clockwise.

■ **When disconnecting and reconnecting battery terminals**

The trip meter data will be reset.

2

When driving

 **NOTICE**

■ **To prevent damage to the engine and its components**

- Do not let the indicator needle of the tachometer enter the red zone, which indicates the maximum engine speed.
- The engine may be overheating if the engine coolant temperature gauge is in the red zone (H). In this case, immediately stop the vehicle in a safe place, and check the engine after it has cooled completely. (→P. 592)

## 2-2. Instrument cluster Indicators and warning lights

The indicators and warning lights on the instrument cluster and center panel inform the driver of the status of the vehicle's various systems.

### Instrument cluster (non-optitron type)

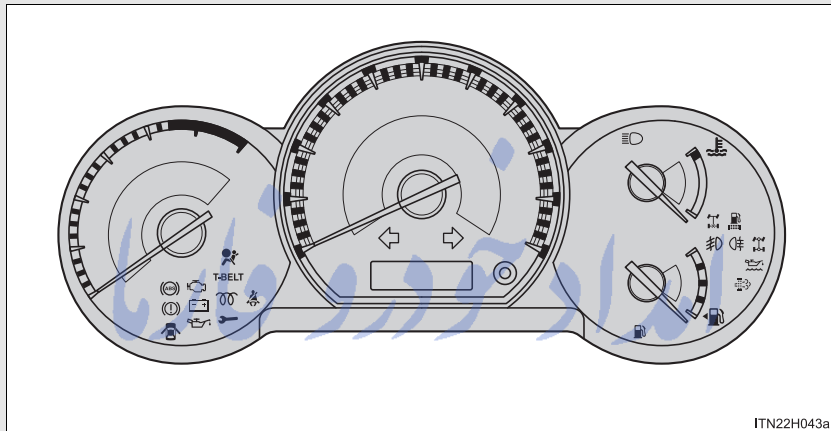

### Instrument cluster (optitron type)

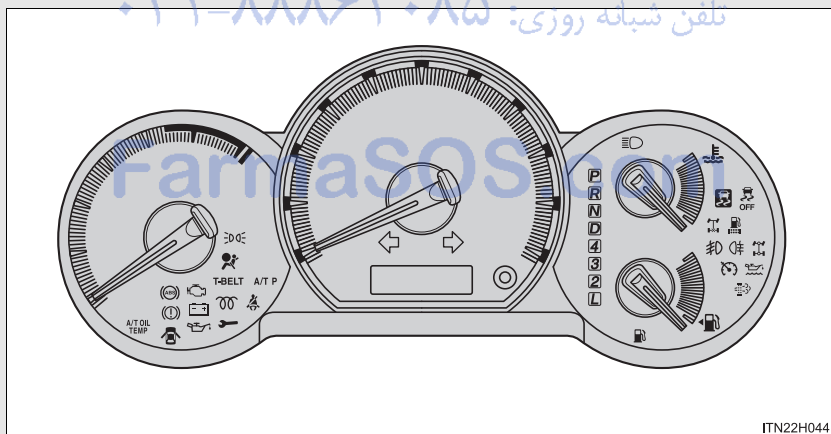

**Center panel (vehicles without multi-information display)**

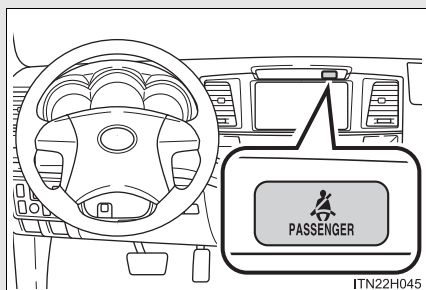

**Center panel (vehicles with multi-information display)**

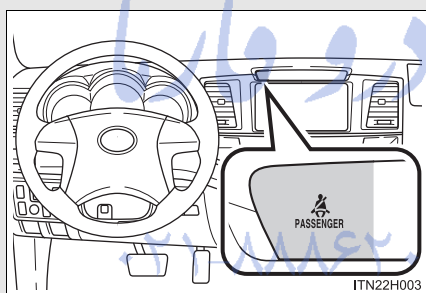











2

When driving

FarmaSOS.com

■ Indicators

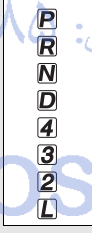
The indicators inform the driver of the operating state of the vehicle's various systems.

	Turn signal indicator (→P. 173)		*1, 2 Slip indicator (→P. 222) (if equipped)
	Headlight high beam indicator (→P. 191)		*1 VSC OFF indicator (→P. 222) (if equipped)
	Tail light indicator (→P. 191) (optitron type meters)		Four-wheel drive indicator (→P. 212) (4WD models)
	Front fog light indicator (→P. 195) (if equipped)		Rear differential lock indicator (→P. 217) (if equipped)
	Rear fog light indicator (→P. 196)		Shift position indicators (→P. 166)
	*1 Engine preheating indicator (→P. 162)		
	Cruise control indicator (→P. 202) (if equipped)		(automatic transmission)

■ **Warning lights**

Warning lights inform the driver of malfunctions in any of the vehicle's systems. (→P. 557)

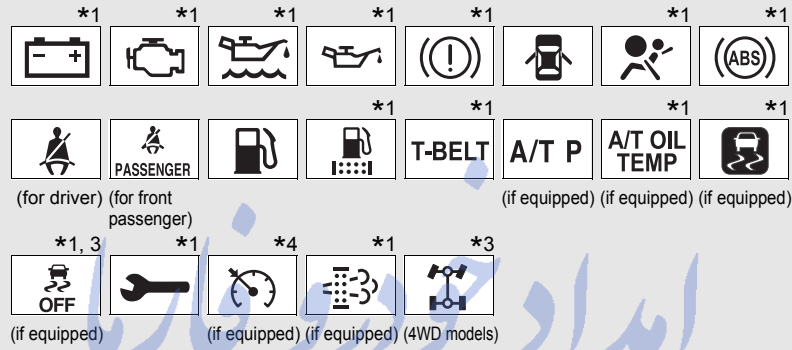

- \*1: These lights turn on when the engine switch is turned to the "ON" position to indicate that a system check is being performed. They will turn off after the engine is started, or after a few seconds. There may be a malfunction in a system if a light does not come on, or if the lights do not turn off. Have the vehicle inspected by any authorized Toyota dealer or repairer, or another duly qualified and equipped professional.
- \*2: The light flashes to indicate that the system is operating.
- \*3: The light flashes to indicate a malfunction.
- \*4: The light turns to yellow (except for Russia and Ukraine) or flashes (for Russia and Ukraine) to indicate a malfunction.

 CAUTION

■ **If a safety system warning light does not come on**

Should a safety system light such as ABS and the SRS warning light not come on when you start the engine, this could mean that these systems are not available to help protect you in an accident, which could result in death or serious injury. Have the vehicle inspected by any authorized Toyota dealer or repairer, or another duly qualified and equipped professional immediately if this occurs.

امداد خودرو فارما

تلفن شبانه روزی: ۰۲۱-۸۸۸۶۲۰۸۵

FarmaSOS.com



## 2-2. Instrument cluster Multi-information display\*

The multi-information display presents the driver with a variety of driving-related data including the current outside air temperature.

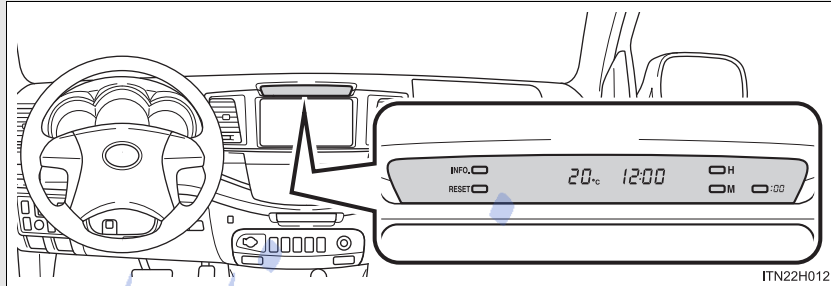

- Trip information (→P. 187)  
Displays driving range, fuel consumption and other cruising-related information.
- Clock (→P. 451)

2

When driving

تلفن شبانه روزی: ۰۲۱-۸۸۶۲۰۸۵

FarmaSOS.com

\*: If equipped

### Switch the display

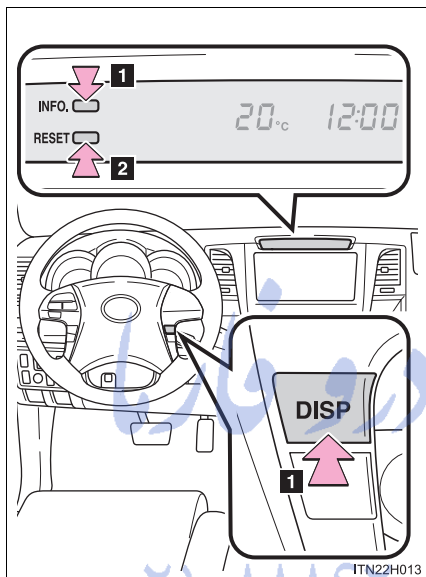

#### 1 "INFO." or "DISP" button

Items displayed can be switched by pressing the "INFO." button or "DISP" button.

The units may differ depending on the target region.

#### 2 "RESET" button

امداد خودرویی  
تلفن شبانه روزی: ۰۲۱-۸۸۸۶۳۰۸۵

FarmaSOS.com

### Display items

#### ■ Outside temperature display



20°C

Displays the outside temperature.

The temperature range that can be displayed is from -40°C (-40°F) to 50°C (122°F).

#### ■ Average fuel consumption



AVG. 13.3 L/100km

Displays the average fuel consumption since the engine switch is turned to the "ON" position.

- The function can be reset by pressing the "RESET" button for longer than 1 second when the average fuel consumption is displayed.
- Use the displayed average fuel consumption as a reference.

#### ■ Current fuel consumption



20.0 L/100km

Displays the current rate of fuel consumption.

#### ■ Average vehicle speed



AVG. 80 km/h

Displays the average vehicle speed since the engine switch is turned to the "ON" position.

The function can be reset by pressing the "RESET" button for longer than 1 second when the average vehicle speed is displayed.

2

When driving

■ **Elapsed time**

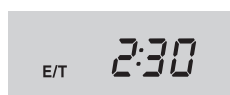

Displays the elapsed time after the engine switch is turned to the “ON” position.

- When the engine switch is turned on, time is counted from 0:00. When the time exceeds 19:59, the counter returns to 0:00.
- The function can be reset by pressing the “RESET” button for longer than 1 second when the elapsed time is displayed.

■ **Driving range**



Displays the estimated maximum distance that can be driven with the quantity of fuel remaining.

- This distance is computed based on your average fuel consumption. As a result, the actual distance that can be driven may differ from that displayed.
- When only a small amount of fuel is added to the tank, the display may not be updated.

■ **Compass**

→P. 459

■ **Display off**

A blank screen is displayed.

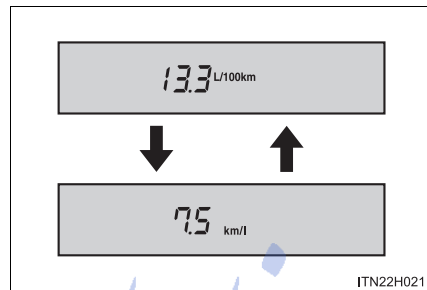
**Set up display (if equipped)**■ **Selecting the units**

Unit for only the fuel consumption rate can be interchanged.

**STEP 1** Switch to the average fuel consumption or current fuel consumption display.

**STEP 2** Hold down the "INFO." button until the unit flashes.

**STEP 3** Push the "RESET" button to change the unit.

**STEP 4** Push the "INFO." button.

تلفن شبانه روزی: ۰۲۱-۸۸۶۲۰۸۵

FarmaSOS.com

2

When driving

---

■ **Outside temperature display**

In the following situations, the correct outside temperature may not be displayed, or the display may take longer than normal to change:

- When the vehicle is stopped, or moving at low speeds (less than 20 km/h [12 mph])
- When the outside temperature has changed suddenly (at the entrance/exit of a garage, tunnel, etc.)

■ **When “-” is displayed**

The system may be malfunctioning. Take your vehicle to any authorized Toyota dealer or repairer, or another duly qualified and equipped professional.

■ **When disconnecting and reconnecting battery terminals**

The following information data and settings will be reset:

- Average fuel consumption
- Average vehicle speed
- Elapsed time

تلفن شبانه روزی: ۰۲۱-۸۸۶۲۰۸۵

FarmaSOS.com

## 2-3. Operating the lights and wipers Headlight switch

The headlights can be operated manually or automatically.

Turning the end of the lever turns on the lights as follows:

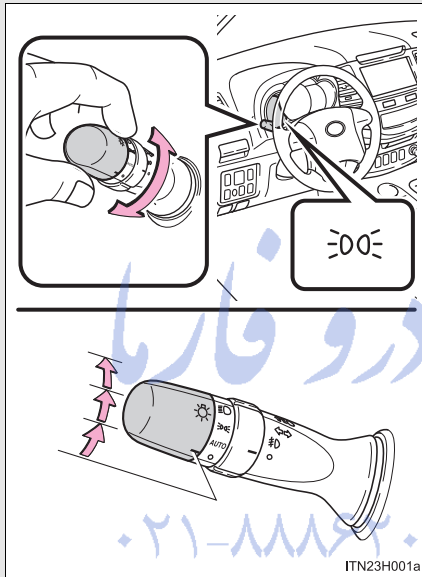

 The front position, tail, license plate and instrument panel lights turn on.

 The headlights and all lights listed above turn on.

**AUTO** (if equipped) The headlights and all the lights listed above turn on and off automatically (when the engine switch is in the "ON" position).

2

When driving

FarmaSOS.com

### Turning on the high beam headlights

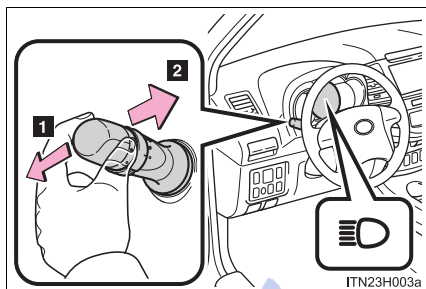

**1** With the headlights on, push the lever away from you to turn on the high beams.

Pull the lever toward you to the center position to turn the high beams off.

**2** Pull the lever toward you and release it to flash the high beams once.

You can flash the high beams with the headlights on or off.

### Manual headlight leveling dial

The level of the headlights can be adjusted according to the number of passengers and the loading condition of the vehicle.

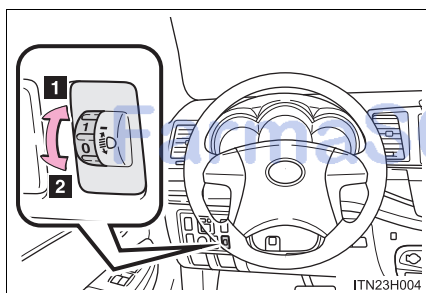

**1** Raises the level of the headlights

**2** Lowers the level of the headlights



■ **Guide to dial settings**

Occupancy and luggage load conditions		Dial position			
		Left-hand drive vehicles			Right-hand drive vehicles
Occupants	Luggage load	Single-cab models	Extra-cab models	Double-cab models	
Driver	None	0	0	0	0
Driver	Full luggage loading	3	4	3.5	5

2

When driving

■ **Daytime running light system (if equipped)**

To make your vehicle more visible to other drivers, the headlights turn on automatically whenever the engine is started. The daytime running light system is not designed for use at night.

■ **Headlight control sensor (if equipped)**

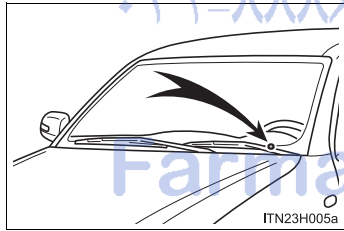

The sensor may not function properly if an object is placed on the sensor, or anything that blocks the sensor is affixed to the windshield.

Doing so interferes with the sensor detecting the level of ambient light and may cause the automatic headlight system to malfunction.

■ **Light reminder buzzer**

A buzzer sounds when the key is removed and the driver's door is opened while the lights are turned on.

## 2-3. Operating the lights and wipers

### NOTICE

#### ■ To prevent battery discharge

Do not leave the lights on longer than necessary when the engine is not running.

امداد خودرو فارما

تلفن شبانه روزی: ۰۲۱-۸۸۸۶۲۰۸۵

FarmaSOS.com

## 2-3. Operating the lights and wipers Fog light switch

The fog lights secure excellent visibility in difficult driving conditions, such as in rain and fog.

### Front fog light switch (if equipped)

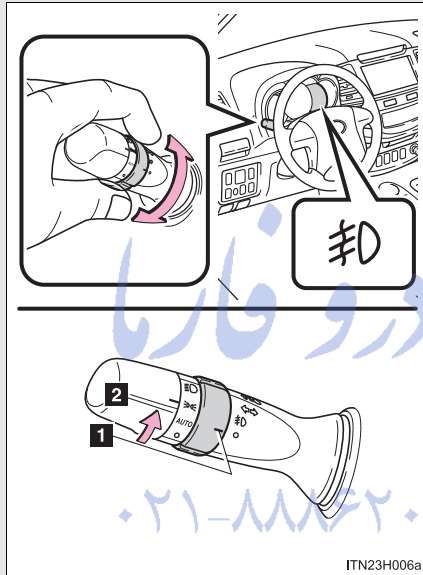

- 1 Turns the front fog lights off
- 2 Turns the front fog lights on

2

When driving

FarmaSOS.com

### Rear fog light switch

#### Type A

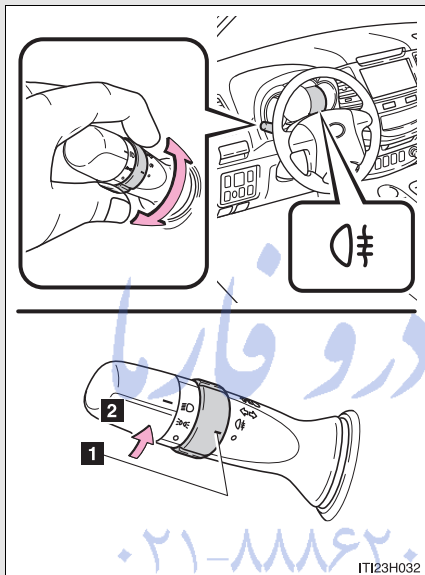

- 1 Turns the rear fog light off
- 2 Turns the rear fog light on

#### Type B

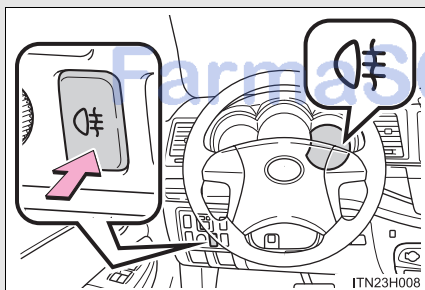

Turns the rear fog light on/off

**Front and rear fog light switch (if equipped)**



- 1** Turns the front and rear fog lights off
- 2** Turns the front fog lights on
- 3** Turns both front and rear fog lights on

2

When driving

تلفن شبانه روزی: ۰۸۵-۸۸۶۲-۲۱

FarmaSOS.com

■ **Fog lights can be used when**

**Vehicles with front fog lights or rear fog lights only**

The headlights or front position lights are turned on.

**Vehicles with both front and rear fog lights**

Front fog lights: The headlights or front position lights are turned on.

Rear fog lights (vehicles with front and rear fog light switch):

The headlights or front position lights are turned on.

Rear fog lights (vehicles with rear fog light switch [type B]):

The headlights are turned on or both the front position lights and front fog lights are turned on.

The rear fog lights will turn off if the front position lights and front fog lights turn off once the headlight switch has been turned to the "AUTO" position.

The rear fog lights will not come on even if the front position lights and front fog lights turn on again.

تلفن شبانه روزی: ۰۲۱-۸۸۸۶۲۰۸۵

FarmaSOS.com

## 2-3. Operating the lights and wipers Windshield wipers and washer

The wiper operation is selected by moving the lever as follows.  
When intermittent windshield wiper operation is selected, the wiper interval can be also adjusted.



- 1 Intermittent windshield wiper operation
- 2 Low speed windshield wiper operation
- 3 High speed windshield wiper operation
- 4 Temporary operation

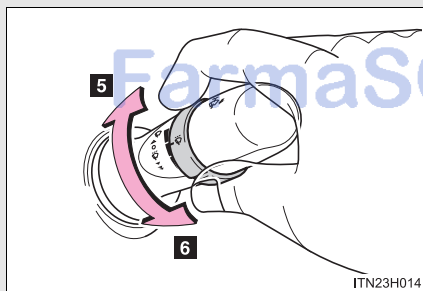

- 5 Increases the intermittent windshield wiper frequency
- 6 Decreases the intermittent windshield wiper frequency

2

When driving

## 2-3. Operating the lights and wipers

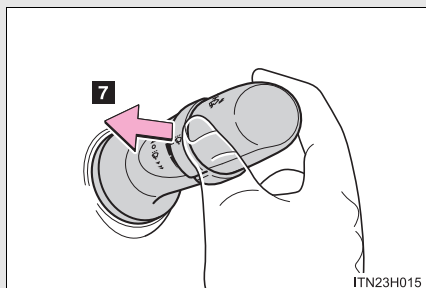

### **7** Washer/wiper dual operation

The wipers will automatically operate a couple of times after the washer squirts.

#### ■ The windshield wiper and washer can be operated when

The engine switch is in the "ON" position.

#### ■ If no windshield washer fluid sprays

Check that the washer nozzles are not blocked if there is washer fluid in the windshield washer fluid reservoir.

#### NOTICE

##### ■ When the windshield is dry

Do not use the wipers, as they may damage the windshield.

##### ■ When the washer fluid tank is empty

Do not operate the switch continually as the washer fluid pump may overheat.

##### ■ When a nozzle becomes blocked

In this case, contact any authorized Toyota dealer or repairer, or another duly qualified and equipped professional.

Do not try to clear it with a pin or other object. The nozzle will be damaged.



## 2-3. Operating the lights and wipers Headlight cleaner switch\*

Washer fluid can be sprayed on the headlights.

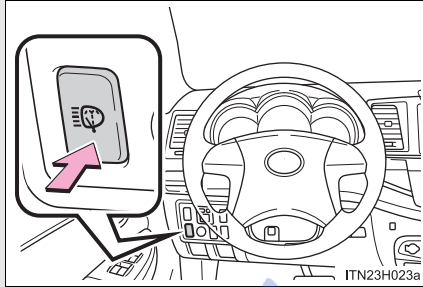

Press the switch to clean the headlights.

2

When driving

### ■ The headlight cleaners can be operated when

The engine switch is in the "ON" position and the headlight switch is turned on.

### ■ Windshield washer linked operation

When the windshield washer is operated with the engine switch in the "ON" position and the headlights on, the headlight cleaners will operate once. (→P. 199)

### ⚠ NOTICE

#### ■ When the washer fluid tank is empty

Do not press the switch continually as the washer fluid pump may overheat.

\*: If equipped

## 2-4. Using other driving systems Cruise control\*

Use the cruise control to maintain a set speed without depressing the accelerator pedal.

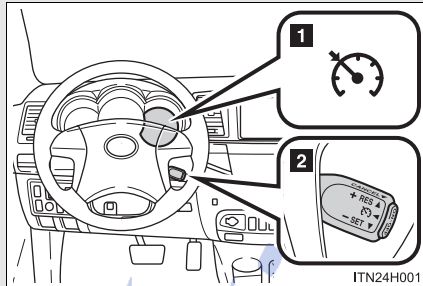

- 1 Indicator
- 2 Cruise control switch

### ■ Setting the vehicle speed

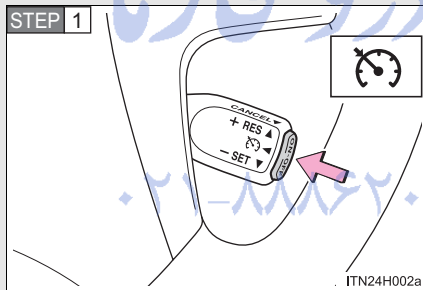

Press the “ON-OFF” button to activate the cruise control.

Cruise control indicator will come on.

Press the button again to deactivate the cruise control.

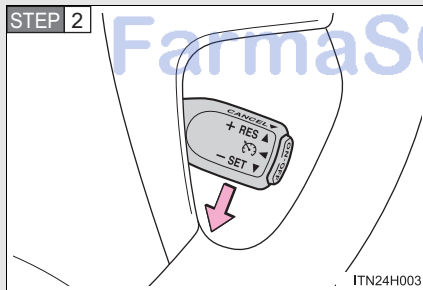

Accelerate or decelerate the vehicle to the desired speed, and push the lever down to set the speed.

The vehicle speed at the moment the lever is released becomes the set speed.

\*: If equipped

### ■ Adjusting the set speed

To change the set speed, operate the lever until the desired set speed is obtained.

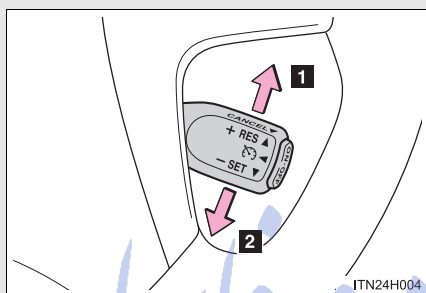

**1** Increases the speed

**2** Decreases the speed

Fine adjustment: Momentarily move the lever in the desired direction.

Large adjustment: Hold the lever in the desired direction.

The set speed will be increased or decreased as follows:

Fine adjustment: By approximately 1.6 km/h (1 mph) each time the lever is operated.

Large adjustment: The set speed can be increased or decreased continually until the lever is released.

2

When driving

FarmaSOS.com

تلفن شبانه روزی: ۰۲۱-۸۸۸۶۲۰۸۵

■ Canceling and resuming the constant speed control

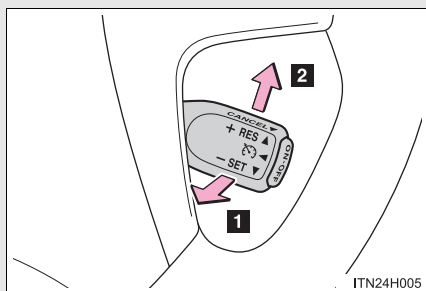

- 1** Pulling the lever toward you cancels the constant speed control.

The speed setting is also canceled when the brakes are applied or the clutch pedal (manual transmission only) is depressed.

- 2** Pushing the lever up resumes the constant speed control.

Resuming is available when the vehicle speed is more than approximately 40 km/h (25 mph).

تلفن شبانه روزی: ۰۲۱-۸۸۶۲۰۸۵

FarmaSOS.com

#### ■ Cruise control can be set when

- The shift lever is in the D or range 4.
- Vehicle speed is above approximately 40 km/h (25 mph).

#### ■ Accelerating after setting the vehicle speed

- The vehicle can be accelerated normally. After acceleration, the set speed resumes.
- Even without canceling the cruise control, the set speed can be increased by first accelerating the vehicle to the desired speed and then pushing the lever down to set the new speed.

#### ■ Automatic cruise control cancelation

Cruise control will stop maintaining the vehicle speed in any of the following situations:

- Actual vehicle speed falls more than approximately 16 km/h (10 mph) below the preset vehicle speed.  
At this time, the memorized set speed is not retained.
- Actual vehicle speed is below approximately 40 km/h (25 mph).
- VSC is activated. (if equipped)

#### ■ If the cruise control indicator light turns to yellow (except for Russia and Ukraine) or flashes (for Russia and Ukraine)

Press the "ON-OFF" button once to deactivate the system, and then press the button again to reactivate the system.

If the cruise control speed cannot be set or if the cruise control cancels immediately after being activated, there may be a malfunction in the cruise control system. Have the vehicle inspected by any authorized Toyota dealer or repairer, or another duly qualified and equipped professional.

 CAUTION

■ **To avoid operating the cruise control by mistake**

Switch the cruise control off using the “ON-OFF” button when not in use.

■ **Situations unsuitable for cruise control**

Do not use cruise control in any of the following situations.

Doing so may result in loss of control and could cause an accident resulting in death or serious injury.

- In heavy traffic
- On roads with sharp bends
- On winding roads
- On slippery roads, such as those covered with rain, ice or snow
- On steep hills  
Vehicle speed may exceed the set speed when driving down a steep hill.
- When your vehicle is towing a trailer or during emergency towing

تلفن شبانه روزی: ۰۲۱-۸۸۶۲۰۸۵

FarmaSOS.com

## 2-4. Using other driving systems Rear view monitor system\*

The rear view monitor assists the driver by displaying an image of the area behind the vehicle while reversing. The image is displayed in reverse on the screen. This reversed image is a similar image to the one on the inside rear view mirror.

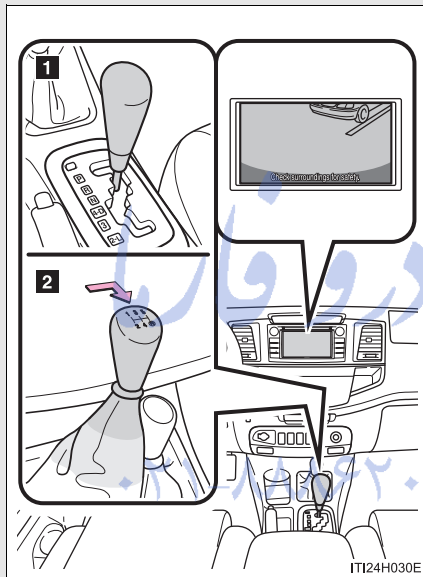

The rear view image is displayed when the shift lever is in the R position.

- 1 Vehicles with automatic transmission
- 2 Vehicles with manual transmission

If the shift lever is shifted out of R, the screen returns to the previous one.

2

When driving

FarmaSOS.com

\*: If equipped

## 2-4. Using other driving systems

### ■ Displayed area

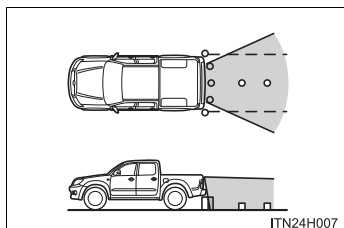

The area covered by the camera is limited. Objects which are close to either corner of the bumper or under the bumper cannot be seen on the screen.

The area displayed on the screen may vary depending on vehicle orientation or road conditions.

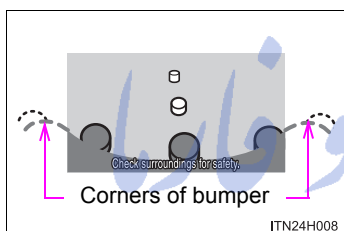

تلفن شبانه روزی: ۰۲۱-۸۸۶۲۰۸۵

FarmaSOS.com



■ Rear view monitor camera

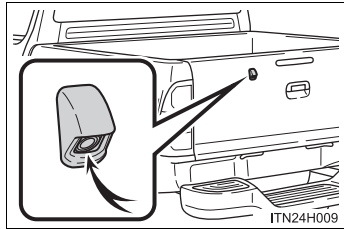

- The camera uses a special lens. The distance of the image that appears on the screen differs from the actual distance.
- In the following cases, it may be difficult to see images on the screen even when the system is functioning correctly:
  - The vehicle is in a dark area, such as at night.
  - The temperature near the lens is extremely high or low.
  - Water droplets are on the camera lens or humidity is high, such as when it rains.
  - Foreign matter, such as snow and mud, adheres to the camera lens.
  - The sun or headlights are shining directly into the camera lens.
  - The camera has scratches or dirt on it.

2

When driving

■ Smear effect

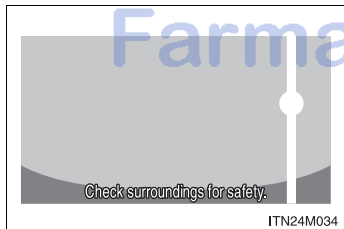

If a bright light, such as sunlight reflected off the vehicle body, is picked up by the camera, a smear effect\* characteristic to the camera may occur.

- \*: Smear effect — A phenomenon that occurs when a bright light is picked up by the camera; when transmitted by the camera, the light source appears to have a vertical streak above and below it.

## 2-4. Using other driving systems

### ■ Flicker effect

When the camera is used under fluorescent lights, sodium lights, or mercury lights etc., the lights and the illuminated areas may appear to flicker.

### ⚠ CAUTION

#### ■ When using the rear view monitor system

Observe the following precautions to avoid an accident that could result in death or serious injuries:

- Never depend solely on the monitor system when reversing.
- Always check visually and with the mirrors to confirm your intended path is clear.
- Depicted distances between objects and flat surfaces differ from actual distances.
- Do not use the system if the tailgate is open.

تلفن شبانه روزی: ۰۲۱-۸۸۶۲۰۸۵

FarmaSOS.com

**⚠ CAUTION****■ Conditions which may affect the rear view monitor system**

- If the back of the vehicle has been hit, the camera's position and mounting angle may have changed. Have the vehicle inspected by any authorized Toyota dealer or repairer, or another duly qualified and equipped professional.
- Rapid temperature changes, such as when hot water is poured on the vehicle in cold weather, may cause the system to function abnormally.
- If the camera lens is extremely dirty, it cannot transmit a clear image. Rinse with water and wipe with a soft cloth. If the camera lens is extremely dirty, wash with a mild cleanser and rinse.
- The displayed image may be darker and moving images may be slightly distorted when the system is cold.
- When washing the vehicle, do not apply intensive bursts of water to the camera or camera area. Doing so may result in the camera malfunctioning.
- Do not strongly rub the camera lens. If the camera lens is scratched, it cannot transmit a clear image.
- Do not allow organic solvent, car wax, window cleaner or glass coat to adhere to the camera. If this happens, wipe it off as soon as possible.
- As the camera has a water proof construction, do not detach, disassemble or modify it. This may cause incorrect operation.
- Do not subject the camera to a strong impact.

2

When driving

## 2-4. Using other driving systems Four-wheel drive system\*

Use the front drive control lever to select the following transfer modes.

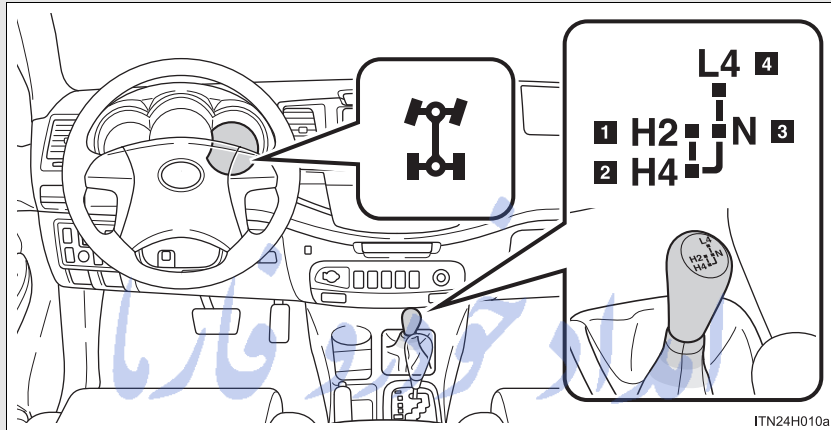

### 1 H2 (high speed position, two-wheel drive)

Use this for normal driving on dry hard-surfaced roads. This position gives greater economy, quietest ride and least wear.

### 2 H4 (high speed position, four-wheel drive)

Use this for driving only on tracks that permit the tires slide, like off-road, icy or snow-covered roads. This position provides greater traction than two-wheel drive.

The four-wheel drive indicator light comes on

\*: If equipped

**3** N (neutral position)

No power is delivered to the wheels. The vehicle must be stopped.

The four-wheel drive indicator light comes on

**4** L4 (low speed position, four-wheel drive)

Use this for maximum power and traction. Use “L4” for climbing or descending steep hills, off-road driving, and hard pulling in sand, mud or deep snow.

The four-wheel drive indicator light comes on

2

When driving

امداد خودرو فارما

تلفن شبانه روزی: ۰۲۱-۸۸۸۶۲۰۸۵

FarmaSOS.com

#### **A.D.D. (automatic disconnecting differential) (if equipped)**

The A.D.D. can be engaged or disengaged by the shifting operations described in the following shifting procedures.

#### **Shifting between H2 and H4**

##### **Shifting from H2 to H4**

**STEP 1** Reduce your speed to less than 80 km/h (50 mph).

**STEP 2** Move the front drive control lever.

##### **Shifting from H4 to H2**

Simply move the front drive control lever.

In both cases, you need not depress the clutch pedal. (manual transmission)

#### **Shifting between H4 and L4 (automatic transmission)**

**STEP 1** Stop the vehicle.

**STEP 2** Shift the shift lever to N.

**STEP 3** Move the front drive control lever.

FarmaSOS.com

**Shifting between H4 and L4 (manual transmission)****Shifting from H4 to L4**

**STEP 1** Stop the vehicle or reduce your speed to less than 8 km/h (5 mph).

**STEP 2** With your foot off the accelerator pedal, depress the clutch pedal.

**STEP 3** Move the front drive control lever.

**Shifting from L4 to H4**

**STEP 1** Depress the clutch pedal.

**STEP 2** Move the front drive control lever.

---

■ **Four-wheel drive usage frequency (vehicles with A.D.D.)**

You should drive in four-wheel drive for at least 16 km (10 miles) each month.

This will assure that the front drive components are lubricated.

■ **Shifting between H2 and H4**

- If you have trouble shifting in cold weather, reduce your speed or stop the vehicle and reshift.
- If the four-wheel drive indicator does not go off when you shift from H4 to H2, drive straight ahead while accelerating or decelerating, or drive in reverse.

■ **Shifting to L4 (vehicles with VSC)**

VSC is automatically turned off.

 CAUTION

■ **While driving**

- Never shift the front drive control lever from H2 to H4 if the wheels are slipping. Stop the slipping or spinning before shifting.
- For normal driving on dry and hard surface roads, use H2 position. Driving on dry and hard surface roads in H4 or L4 position may cause drive component oil leakage, seizure, or other problems resulting in an accident. Further, it may cause tire wear and increased fuel consumption.
- Avoid turning suddenly in H4 or L4 position. If you do turn suddenly, the difference in turning speeds between the front and rear wheels may have a similar effect to braking, thus making driving difficult.
- Securely shift the front drive control lever to H4 or L4. Otherwise, the transfer may disengage both the front and rear driveshafts from the powertrain and allow the vehicle to move regardless of the shift position. If this happens, the vehicle may be free to roll even if the automatic transmission is in P.

تلفن شبانه روزی: ۰۲۱-۸۸۶۲۰۸۵

FarmaSOS.com



## 2-4. Using other driving systems Rear differential lock system\*

The rear differential lock system is provided for use only when wheel spinning occurs in a ditch or on a slippery or ragged surface.

This differential lock system is effective in case one of the rear wheels is spinning.

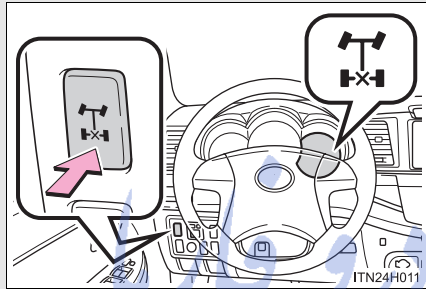

Press the rear differential lock switch to lock the rear differential.

At this time, the rear differential lock indicator will blink. Wait a few seconds for the system to complete operation. After the rear differential is locked, the indicator will stop blinking and remain on.

To unlock the rear differential, push the switch again.

2

When driving

تلفن شبانه روزی: ۰۲۱-۸۸۸۶۲۰۸۵

FarmaSOS.com

\*: If equipped

### Using the rear differential lock system

#### Automatic transmission

**STEP 1** 4WD models only: Before using the rear differential lock system, try shifting the front drive control lever into L4. If this is not sufficient, use the rear differential lock system as well.

**STEP 2** Be sure to stop the wheels.

**STEP 3** Press the rear differential lock switch.

**STEP 4** Gently depress the accelerator pedal.

After the rear differential is locked, the indicator will come on.

Unlock the rear differential as soon as the vehicle moves.

#### Manual transmission

**STEP 1** 4WD models only: Before using the rear differential lock system, try shifting the front drive control lever into L4. If this is not sufficient, use the rear differential lock system as well.

**STEP 2** Be sure to stop the wheels.

**STEP 3** Depress the clutch pedal.

**STEP 4** Press the rear differential lock switch.

**STEP 5** Slowly release the clutch pedal.

After the rear differential is locked, the indicator will come on.

Unlock the rear differential as soon as the vehicle moves.

■ **Locking the rear differential**

The following systems do not operate when the rear differential is locked. It is normal operation for the ABS warning light, VSC OFF indicator (if equipped) and slip indicator (if equipped) to be on at this time.

- ABS
- Brake assist (if equipped)
- VSC (if equipped)
- TRC (if equipped)

■ **For easy unlocking**

Slightly turn the steering wheel in either direction while the vehicle is in motion.

■ **Automatic unlocking feature (4WD models)**

Shift the front drive control lever to H2 or H4. Never forget to turn off the switch after using this feature.

■ **After unlocking the rear differential**

Check that the indicator goes off.

تلفن شبانه روزی: ۰۲۱-۸۸۶۲۰۸۵

FarmaSOS.com

 CAUTION

■ **To avoid an accident**

Failure to observe the following precautions may result in an accident.

- Do not use the rear differential lock system except when wheel spinning occurs in a ditch or on a slippery or rugged surface. Large steering effort and careful cornering control will be required.
- Do not lock the rear differential until the wheels have stopped spinning. Otherwise, the vehicle may move in an unexpected direction when the differential lock is engaged, resulting in an accident. This may also lead to possible damage to rear differential lock component parts.
- Do not drive over 8 km/h (5 mph) when the differential is locked.
- Do not keep driving with the rear differential lock switch on.

تلفن شبانه روزی: ۰۲۱-۸۸۸۶۲۰۸۵

FarmaSOS.com

## 2-4. Using other driving systems

### Driving assist systems

To help enhance driving safety and performance, the following systems operate automatically in response to various driving situations. Be aware, however, that these systems are supplementary and should not be relied upon too heavily when operating the vehicle.

■ **ABS (Anti-lock Brake System)**

Helps to prevent wheel lock when the brakes are applied suddenly, or if the brakes are applied while driving on a slippery road surface

■ **Brake assist (if equipped)**

Generates an increased level of braking force after the brake pedal is depressed when the system detects a panic stop situation

■ **VSC (Vehicle Stability Control) (if equipped)**

Helps the driver to control skidding when swerving suddenly or turning on slippery road surfaces

■ **TRC (Traction Control) (if equipped)**

Helps to maintain drive power and prevent the drive wheels from spinning when starting the vehicle or accelerating on slippery roads

■ **LSD (Limited Slip Differential) (if equipped)**

Helps traction when one rear wheel begins to spin by automatically transmitting driving force to the other rear wheel

2

When driving

FarmaSOS.com

### When the VSC/TRC systems are operating

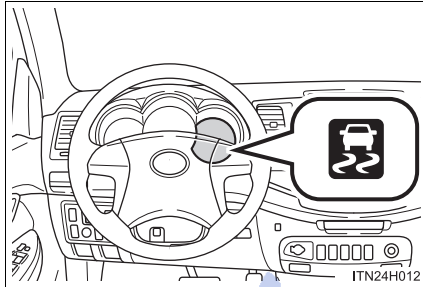

If the vehicle is in danger of slipping or if any of the drive wheels spins, the slip indicator flashes to indicate that the VSC/TRC systems are operating.

### Disabling the TRC/VSC systems

If the vehicle gets stuck in fresh snow or mud, the TRC/VSC systems may reduce power from the engine to the wheels. You may need to turn the system off to enable you to rock the vehicle in order to free it.

#### ■ Turning off TRC system only

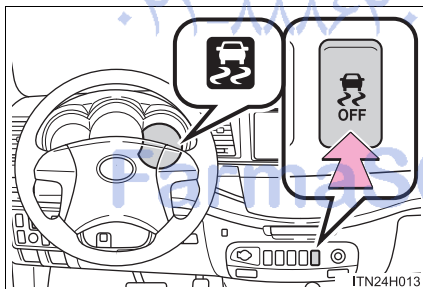

To turn the TRC system off, quickly press and release the button.

The slip indicator light will come on.

Press the button again to turn the system back on.

■ Turning off both TRC and VSC systems

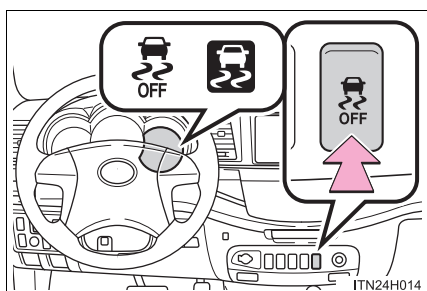

To turn the TRC and VSC systems off, press and hold the button for more than 3 seconds while the vehicle is stopped.

The slip indicator light and VSC OFF indicator light will come on.

Press the button again to turn the system back on.

2

When driving

امداد خودرو فارما

تلفن شبانه روزی: ۰۲۱-۸۸۸۶۲۰۸۵

FarmaSOS.com

---

■ **Sounds and vibrations caused by the ABS, brake assist, VSC and TRC**

- A sound may be heard from the engine compartment when the engine is started or just after the vehicle begins to move. This sound does not indicate that a malfunction has occurred in any of these systems.
- Any of the following conditions may occur when the above systems are operating. None of these indicates that a malfunction has occurred.
  - Vibrations may be felt through the vehicle body and steering.
  - A motor sound may be heard after the vehicle comes to a stop.
  - The brake pedal may pulsate slightly after the ABS is activated.
  - The brake pedal may move down slightly after the ABS is activated.

■ **Reactivation of the TRC/VSC systems after turning off the engine**

Turning off the engine after turning off the TRC/VSC systems will automatically reactivate them.

■ **Reactivation of the TRC system linked to vehicle speed**

When only the TRC system is turned off, the TRC system will turn on when vehicle speed increases. However, when both TRC and VSC systems are turned off, the systems will not turn on even when vehicle speed increases.

■ **If the VSC OFF indicator light blinks and the slip indicator light comes on...**

It may indicate a malfunction in the VSC and TRC. Consult any authorized Toyota dealer or repairer, or another duly qualified and equipped professional.

FarmaSOS.com



**⚠ CAUTION****■ The ABS does not operate effectively when**

- The limits of tire gripping performance have been exceeded (such as excessively worn tires on a snow covered road).
- The vehicle hydroplanes while driving at high speed on the wet or slick road.

**■ Stopping distance when the ABS is operating may exceed that of normal conditions**

The ABS is not designed to shorten the vehicle's stopping distance. Always maintain a safe distance from the vehicle in front of you, especially in the following situations:

- When driving on dirt, gravel or snow-covered roads
- When driving with tire chains
- When driving over bumps in the road
- When driving over roads with potholes or uneven surfaces

**■ TRC may not operate effectively when**

Directional control and power may not be achievable while driving on slippery road surfaces, even if the TRC system is operating. Do not drive the vehicle in conditions where stability and power may be lost.

**■ When the VSC is activated**

The slip indicator light flashes. Always drive carefully. Reckless driving may cause an accident. Exercise particular care when the indicator light flashes.

**■ When the TRC/VSC systems are turned off**

Be especially careful and drive at a speed appropriate to the road conditions. As these are the systems to ensure vehicle stability and driving force, do not turn the TRC/VSC systems off unless necessary.

 CAUTION

■ **Replacing tires**

Make sure that all tires are of the specified size, brand, tread pattern and total load capacity. In addition, make sure that the tires are inflated to the recommended tire inflation pressure level.

The ABS and VSC systems will not function correctly if different tires are installed on the vehicle.

Contact any authorized Toyota dealer or repairer, or another duly qualified and equipped professional for further information when replacing tires or wheels.

■ **Handling of tires and the suspension**

Using tires with any kind of problem or modifying the suspension will affect the driving assist systems, and may cause the system to malfunction.

تلفن شبانه روزی: ۰۲۱-۸۸۶۲۰۸۵

FarmaSOS.com

## 2-4. Using other driving systems

### DPF (Diesel Particulate Filter) system\*

When the deposit collected by the filter reaches a predetermined amount, it is automatically regenerated.

#### ■ Regeneration

Regeneration is performed as necessary in accordance with driving conditions.

#### ■ System characteristics

The DPF system has the following characteristics:

- Idle speed increases during regeneration
- The smell of the exhaust gas differs from that of a conventional diesel vehicle

#### DPF system failure warning

##### Vehicles without the DPF system switch

If the DPF system warning light turns on, drive continuously.  
(→P. 563)

If the DPF system warning light flashes, have the vehicle inspected by any authorized Toyota dealer or repairer, or another duly qualified and equipped professional, immediately. (→P. 560)

2

When driving

\*: If equipped

### Vehicles with the DPF system switch

If the DPF system warning light and the indicator light on DPF system switch turn on or flash, follow the procedure below to regenerate.

**STEP 1** Stop the vehicle in a safe place.

**STEP 2** Firmly set the parking brake and shift the shift lever to P (automatic transmission) or N (manual transmission). Release the clutch pedal.

Do not stop the engine.

Also, make sure that there are no flammable materials near the exhaust pipe. (→P. 230)

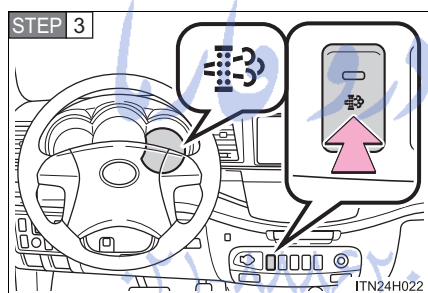

Press the switch.

The DPF system warning light and the indicator light on the switch will change from solid or rapid flashing to slow flashing, and the idling engine speed will increase.

Regeneration will take around 20 - 30\* minutes to complete.

When the DPF system warning light goes out, the idling engine speed will have finished returning to normal.

\*: Differs in accordance with the outside temperature.

■ **Regeneration with the DPF system switch (if equipped)**

- After pressing the DPF system switch, do not depress the accelerator pedal or the clutch pedal (manual transmission). Depressing the pedal(s) will stop regeneration. If regeneration has been stopped, restart regeneration as soon as possible.
- If regeneration is carried out while the exhaust pipe is hot (for example directly after driving), it will take less time than when the engine is cold.

■ **Replacing the engine oil**

Make sure to use an oil of the recommended grade or of matching quality. (→P. 610)

■ **DPF system warning**

Under the following driving conditions, the DPF system warning light may come on earlier than normal.\*

- When only driving at low speeds (for example 20 km/h [12 mph] or below).
- If the engine is turned on and off frequently (if the engine is not left running for more than 10 minutes at a time).

\*: Differs in accordance with weather, driving conditions, etc.

2

When driving

FarmaSOS.com

**⚠ CAUTION**

■ **During regeneration**

Observe the following precautions.

Failure to do so may result in burning injuries caused by the hot exhaust pipe and exhaust gases, or may cause a fire.

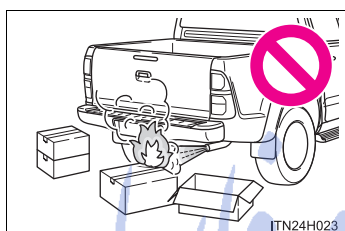

- Do not place flammable materials near the exhaust pipe.

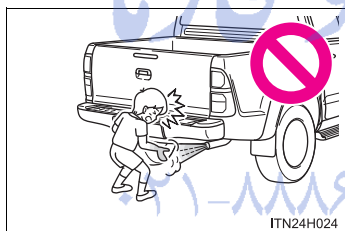

- Make sure that there are no people near the exhaust pipe.

- Vehicles with the DPF system switch: Do not carry out regeneration when the vehicle is in an enclosed area, such as a garage.
- Do not touch the exhaust pipe and exhaust gases during regeneration.

 CAUTION

■ **If the malfunction indicator light comes on**

The malfunction indicator light comes on if you continue driving while the DPF system warning light is flashing. In this event, damage may be caused to the vehicle or an accident may occur. Have the vehicle inspected by any authorized Toyota dealer or repairer, or another duly qualified and equipped professional, immediately.

 NOTICE

■ **To prevent the DPF system from failing**

- Do not drive for long periods of time while the DPF system warning light is flashing
- Do not use fuel other than the specified type
- Do not use engine oil other than the recommended type
- Do not modify the exhaust pipe

2

When driving

امداد خودرو فارما  
تلفن شبانه روزی: ۰۲۱-۸۸۸۶۲۰۸۵  
FarmaSOS.com

## 2-5. Driving information

### Cargo and luggage

Take notice of the following information about storage precautions, cargo capacity and load:

- Stow cargo and luggage in the rear deck whenever possible.
- Be sure all items are secured in place.
- To maintain vehicle balance while driving, position luggage evenly in the rear deck.
- For better fuel economy, do not carry unnecessary weight.

امداد خودرو فارما

تلفن شبانه روزی: ۰۸۵-۸۸۸۶۲۰۲۱

FarmaSOS.com



**⚠ CAUTION****■ Things that must not be carried in the rear deck**

The following things may cause a fire if loaded in the rear deck:

- Receptacles containing gasoline
- Aerosol cans

**■ Storage precautions**

Observe the following precautions.

Failure to do so may result in death or serious injury.

- Stow cargo and luggage in the rear deck whenever possible.
- Except for single-cab models: Do not stack anything behind the front seats higher than the seatbacks.  
Such items may be thrown about and possibly injure people in the vehicle in the event of a sudden braking, sudden swerving or an accident.
- Do not place cargo or luggage in or on the following locations as the item may get under the clutch, brake or accelerator pedal and prevent the pedals from being depressed properly, block the driver's vision, or hit the driver or passengers, causing an accident:
  - At the feet of the driver
  - On the front passenger seats (when stacking items)
  - Except for single-cab models: On the rear seat (when stacking items)
  - On the instrument panel
  - On the dashboard

2

When driving

 CAUTION

- Secure all items in the occupant compartment, as they may shift and injure someone in the event of a sudden braking, sudden swerving or an accident.
- Never allow anyone to ride in the rear deck. It is not designed for passengers. They should ride in their seats with their seat belts properly fastened. Otherwise, they are much more likely to suffer death or serious bodily injury, in the event of a sudden braking, sudden swerving or an accident.
- **Load and distribution**
  - Do not overload your vehicle.
  - Do not apply loads unevenly. Improper loading may cause deterioration of steering or braking control which may cause death or serious injury.

تلفن شبانه روزی: ۰۲۱-۸۸۶۲۰۸۵

FarmaSOS.com

## 2-5. Driving information

### Winter driving tips

Carry out the necessary preparations and inspections before driving the vehicle in winter. Always drive the vehicle in a manner appropriate to the prevailing weather conditions.

#### ■ Pre-winter preparations

- Use fluids that are appropriate to the prevailing outside temperatures.
  - Engine oil
  - Engine coolant
  - Washer fluid
- Have a service technician inspect the level and specific gravity of battery electrolyte.
- Have the vehicle fitted with four snow tires or purchase a set of tire chains for the rear tires.

Ensure that all tires are the same size and brand, and that chains match the size of the tires.

تلفن شبانه روزی: ۰۸۵-۸۸۶۲۰۸۵-۲۱

FarmaSOS.com

2

When driving

■ **Before driving the vehicle**

Perform the following according to the driving conditions:

- Do not try to forcibly open a window or move a wiper that is frozen. Pour warm water over the frozen area to melt the ice. Wipe away the water immediately to prevent it from freezing.
- To ensure proper operation of the climate control system fan, remove any snow that has accumulated on the air inlet vents in front of the windshield.
- Remove any ice that has accumulated on the vehicle chassis.
- Periodically check for and remove any excess ice or snow that may have accumulated in the wheel well or on the brakes.

■ **When driving the vehicle**

Accelerate the vehicle slowly and drive at a reduced speed suitable to road conditions.

■ **When parking the vehicle (in the winter time or in the cold latitudes)**

Park the vehicle and move the shift lever to P (automatic transmission) or 1 or R (manual transmission) without setting the parking brake. The parking brake may freeze up, preventing it from being released. If necessary, block the wheels to prevent inadvertent sliding or creeping.

**Selecting tire chains**

Use the correct tire chain size when mounting the snow chains. Chain size is regulated for each tire size.

**Regulations on the use of tire chains**

Regulations regarding the use of tire chains vary depending on location and type of road. Always check local regulations before installing chains.

**■ Tire chain installation**

Observe the following precautions when installing and removing chains:

- Install and remove tire chains in a safe location.
- Install tire chains on the rear tires. Do not install tire chains on the front tires.
- Install tire chains on rear tires as tightly as possible. Retighten chains after driving 0.5 - 1.0 km (1/4 - 1/2 mile).
- Install tire chains following the instructions provided with the tire chains.

2

When driving

FarmaSOS.com

 CAUTION

■ **Driving with snow tires**

Observe the following precautions to reduce the risk of accidents. Failing to do so may result in a loss of vehicle control and cause death or serious injury.

- Use tires of the specified size.
- Maintain the recommended level of air pressure.
- Do not drive at speeds in excess of the speed limit or the speed limit specified for the snow tires being used.
- Use snow tires on all, not just some wheels.

■ **Driving with tire chains**

Observe the following precautions to reduce the risk of accidents. Failing to do so may result in the vehicle being unable to be driven safely, and may cause death or serious injury.

- Do not drive in excess of the speed limit specified for the tire chains being used, or 50 km/h (30 mph), whichever is lower.
- Avoid driving on bumpy road surfaces or over potholes.
- Avoid sudden turns and braking, as use of chains may adversely affect vehicle handling.
- Slow down sufficiently before entering a curve to ensure that vehicle control is maintained.

## 2-5. Driving information

### Trailer towing

Your vehicle is designed primarily as a passenger carrying vehicle. Towing a trailer will have an adverse effect on handling, performance, braking, durability, and fuel consumption. Your safety and satisfaction depend on the proper use of correct equipment and cautious driving habits. For your safety and the safety of others, do not overload the vehicle or trailer.

To tow a trailer safely, use extreme care and drive the vehicle in accordance with the trailer's characteristics and operating conditions.

Toyota warranties do not apply to damage or malfunction caused by towing a trailer for commercial purposes.

Ask your local authorized Toyota dealer or repairer, or another duly qualified and equipped professional for further details before towing, as there are additional legal requirements in some countries.

#### ■ Weight limits

Check the allowable towing capacity, GVM (Gross Vehicle Mass), MPAC (Maximum Permissible Axle Capacity), and permissible draw bar load before towing. (→P. 603)

#### ■ Towing hitch/bracket

Toyota recommends the use of the Toyota hitch/bracket for your vehicle. Other products of a suitable nature and comparable quality may also be used.

### Important points regarding trailer loads

#### ■ Total trailer weight and permissible drawbar load

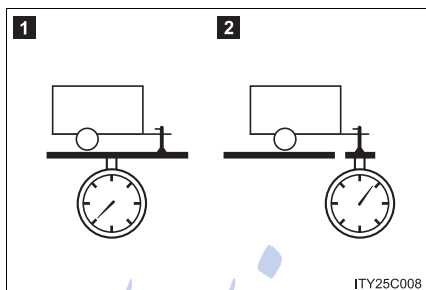

##### 1 Total trailer weight

Weight of the trailer itself plus the trailer load should be within the maximum towing capacity. Exceeding this weight is dangerous. (→P. 603)

When towing a trailer, use a friction coupler or friction stabilizer (sway control device).

When the total trailer weight is over 2000 kg (4409 lb.), a friction stabilizer (sway control device) is required.

##### 2 Permissible drawbar load

Allocate the trailer load so that the drawbar load is greater than 25 kg (55.1 lb.) or 4% of the towing capacity. Do not let the drawbar load exceed the indicated weight. (→P. 603)



■ Information tag (manufacturer's label)

Type A

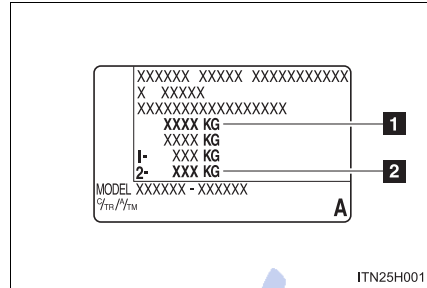

- 1 Gross vehicle mass
- 2 Maximum permissible rear axle capacity

Type B

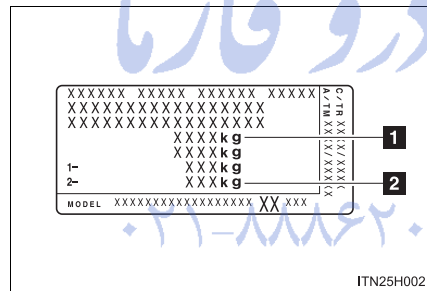

■ Gross vehicle mass

The combined weight of the driver, passengers, cargo, towing hitch, total curb mass and drawbar load must not exceed the gross vehicle mass. Exceeding this weight is dangerous.

■ Maximum permissible rear axle capacity

The weight borne by the rear axle should not exceed the maximum permissible axle capacity. Exceeding this weight is dangerous.

The values for towing capacity were derived from testing conducted at sea level. Take note that engine output and towing capacity will be reduced at high altitudes.

2

When driving

**Installation positions for the towing hitch/bracket and hitch ball**

**Vehicles with flat bumper or without bumper**

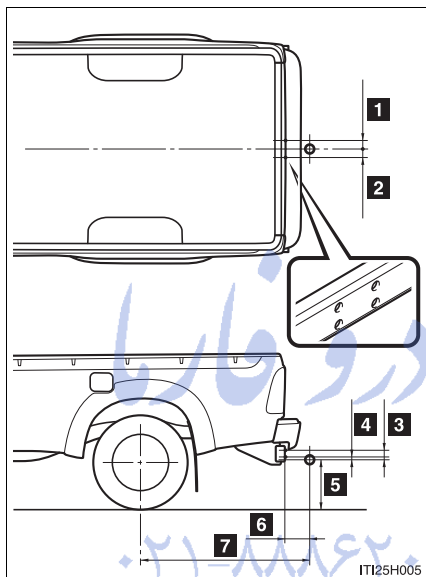

- 1** 70 mm (2.8 in.)
- 2** 70 mm (2.8 in.)
- 3** 75 mm (3.0 in.)
- 4** 20 mm (0.8 in.)
- 5** Single-cab models:  
355 mm (14.0 in.)  
Extra-cab models:  
320 mm (12.6 in.)  
Double-cab models:  
330 mm (13.0 in.)
- 6** 195 mm (7.7 in.)
- 7** 1355 mm (53.3 in.)

تلفن شبانه روزی: ۰۲۱-۸۸۶۲۰۸۵

FarmaSOS.com

**Vehicles with step bumper**

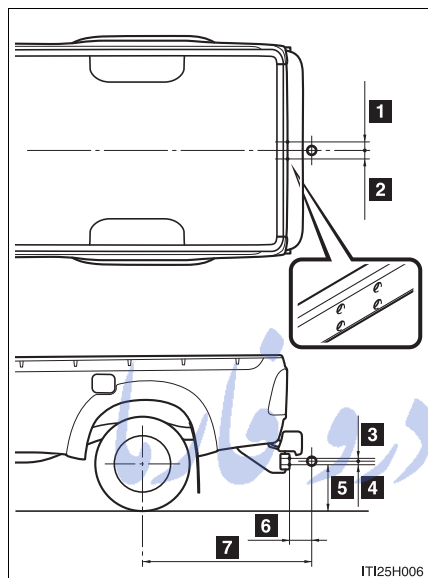

- 1** 70 mm (2.8 in.)
- 2** 70 mm (2.8 in.)
- 3** 20 mm (0.8 in.)
- 4** 35 mm (1.4 in.)
- 5** Single-cab models:  
360 mm (14.2 in.)  
Extra-cab models:  
325 mm (12.8 in.)  
Double-cab models:  
335 mm (13.2 in.)
- 6** 195 mm (7.7 in.)
- 7** 1375 mm (54.1 in.)

2

When driving

تلفن شبانه روزی: ۰۲۱-۸۸۶۲۰۸۵

FarmaSOS.com

---

■ **Tire information**

- Ensure that your vehicle's tires are properly inflated. (→P. 620)
- Increase the air pressure of the trailer tires in accordance with the total trailer weight and according to the values recommended by the manufacturer of your trailer.

■ **Trailer lights**

Check that the turn signal lights and stoplights are operating correctly every time you hitch up the trailer. Directly wiring up to your vehicle may damage the electrical system and stop the lights from functioning correctly.

■ **Break-in schedule**

Toyota recommends that vehicles fitted with new power train components should not be used for towing trailers for the first 800 km (500 miles).

■ **Safety checks before towing**

- Check that the maximum load limit for the towing hitch/bracket hitch ball is not exceeded. Bear in mind that the coupling weight of the trailer will add to the load exerted on the vehicle. Also make sure that the total load exerted on the vehicle is within the range of the weight limits. (→P. 240)
- Ensure that the trailer load is secure.
- Supplementary outside rear view mirrors should be added to the vehicle if the traffic behind cannot be clearly seen with standard mirrors. Adjust the extending arms of these mirrors on both sides of the vehicle so that they always provide maximum visibility of the road behind.

### ■ Maintenance

- Maintenance must be performed more frequently when using the vehicle for towing due to the greater weight burden placed on the vehicle compared to normal driving.
- Retighten all bolts securing the hitching ball and bracket after towing for approximately 1000 km (600 miles).

#### NOTICE

##### ■ When the rear bumper strengthening material is aluminum

Ensure the steel bracket part does not come directly in contact with that area.

When steel and aluminum come into contact, there is a reaction similar to corrosion, which will weaken the section concerned which may result in damage. Apply a rust inhibitor to parts that will come in contact when attaching a steel bracket.

2

When driving

تلفن شبانه روزی: ۰۲۱-۸۸۶۲۰۸۵

FarmaSOS.com

### Guidance

Your vehicle will handle differently when towing a trailer. In order to avoid accident, death or serious injury, keep the following in mind when towing:

#### ■ Checking connections between trailer and lights

Stop the vehicle and check the operation of the connection between the trailer and lights after driving for a brief period as well as before starting off.

#### ■ Practicing driving with a coupled trailer

- Get the feel for turning, stopping and reversing with the trailer coupled by practicing in an area with no or light traffic.
- When reversing with a coupled trailer, hold the section of the steering wheel nearest to you and rotate clockwise to turn the trailer left or counterclockwise to turn it right. Always rotate a little at a time to prevent steering error. Have someone guide you when reversing to lessen the risk of accident.

#### ■ Increasing vehicle-to-vehicle distance

At a speed of 10 km/h (6 mph), the distance to the vehicle running ahead of you should be equivalent to or greater than the combined length of your vehicle and trailer. Avoid sudden braking that may cause skidding. Otherwise, the vehicle may spin out of control. This is especially true when driving on wet or slippery road surfaces.

■ **Sudden acceleration/steering input/cornering**

Executing sharp turns when towing may result in the trailer colliding with your vehicle. Decelerate well in advance when approaching turns and take them slowly and carefully to avoid sudden braking.

■ **Important points regarding turning**

The wheels of the trailer will travel closer to the inside of the curve than the wheels of the vehicle. To make allowance for this, take the turns wider than you would normally do.

■ **Important points regarding stability**

Vehicle movement resulting from uneven road surfaces and strong crosswinds will affect handling. The vehicle may also be rocked by passing buses or large trucks. Frequently check behind when moving alongside such vehicles. As soon as such vehicle movement occurs, immediately start to decelerate smoothly by slowly applying the brakes. Always steer the vehicle straight ahead while braking.

■ **Passing other vehicles**

Consider the total combined length of your vehicle and trailer and ensure that the vehicle-to-vehicle distance is sufficient before executing lane changes.

■ **Transmission information**

To maintain engine braking efficiency when using engine braking, do not use the transmission in D (automatic transmission) or in the 5th gear (manual transmission). (→P. 166, 170)

■ **If the engine overheats**

Towing a loaded trailer up a long, steep incline in temperatures exceeding 30°C (85°F) may result in the engine overheating. If the engine coolant temperature gauge indicates that the engine is overheating, turn the air conditioning off immediately, leave the road and stop the vehicle in a safe place. (→P. 592)

■ **When parking the vehicle**

Always place wheel chocks under the wheels of both the vehicle and trailer. Firmly set the parking brake and shift the shift lever to P for automatic transmissions, and 1 or R for manual transmissions.

 **CAUTION**

Follow all the precautions described in this section. Failure to do so could cause an accident resulting in death or serious injury.

■ **Trailer towing precautions**

When towing, make sure that none of the weight limits are exceeded. (→P. 240)

■ **Vehicle speed in towing**

Observe the legal maximum speeds for trailer towing.

■ **Before descending hills or long declines**

Reduce speed and downshift. However, never downshift suddenly while descending steep or long down hill grades.

■ **Operation of the brake pedal**

Do not hold the brake pedal depressed often or for long periods of time. Doing so may result in the brake overheating or reduce braking effects.



**⚠ CAUTION****■ To avoid accident or injury**

The gross combination mass (sum of your vehicle mass plus its load and the total trailer mass) must not exceed the following:

**Single-cab models**

5140 kg (11332 lb.)

**Extra-cab models**

5120 kg (11288 lb.): 4WD models

5090 kg (11222 lb.): Pre Runner

**Double-cab models**

5220 kg (11508 lb.): 1KD-FTV engine for Norway

5230 kg (11530 lb.): 1KD-FTV engine except for Norway

5180 kg (11420 lb.): 2KD-FTV engine, 4WD models for Norway

5190 kg (11442 lb.): 2KD-FTV engine, 4WD models except for Norway

5100 kg (11244 lb.): 2KD-FTV engine, Pre Runner

2

When driving

تلفن شبانه روزی: ۰۲۱-۸۸۶۲۰۸۵

FarmaSOS.com

**3-1. Using the air conditioning system and defogger**

Manual air conditioning system ..... 252

Automatic air conditioning system ..... 258

Power heater ..... 265

Rear window defogger switch..... 266

**3-2. Using the audio system**

Audio system types..... 268

Using the radio..... 270

Using the CD player..... 275

Playing MP3 and WMA discs ..... 282

Operating an iPod..... 290

Operating a USB memory..... 300

Optimal use of the audio system ..... 309

Using the AUX port..... 313

Using the steering wheel audio switches ..... 314

## Interior features

# 3

### 3-3. Using the “touch screen”

Touch screen .....	317
Setup menu .....	319
Audio system .....	327
Using the radio .....	331
Using the CD player .....	336
Playing an audio CD and MP3/WMA discs .....	337
Listening to an iPod .....	350
Listening to a USB memory .....	360
Using the AUX port .....	369
Listening to Bluetooth® audio .....	370
Using the steering wheel audio switches .....	384
Hands-free system (for cellular phone) .....	387
Using the Bluetooth® phone .....	395
Setting the hands-free system .....	411
Bluetooth® settings .....	428

### 3-4. Using the interior lights

Interior lights list .....	438
• Personal lights .....	439
• Interior light .....	439

### 3-5. Using the storage features

List of storage features .....	440
• Glove box .....	442
• Console box .....	443
• Cup holders .....	444
• Bottle holders .....	446
• Auxiliary boxes .....	447

### 3-6. Other interior features

Sun visors .....	449
Vanity mirror .....	450
Clock .....	451
Ashtray .....	452
Cigarette lighter .....	453
Power outlet .....	454
Seat heaters .....	455
Floor mat .....	457
Compass .....	459
Deck hooks .....	465

### 3-1. Using the air conditioning system and defogger Manual air conditioning system\*

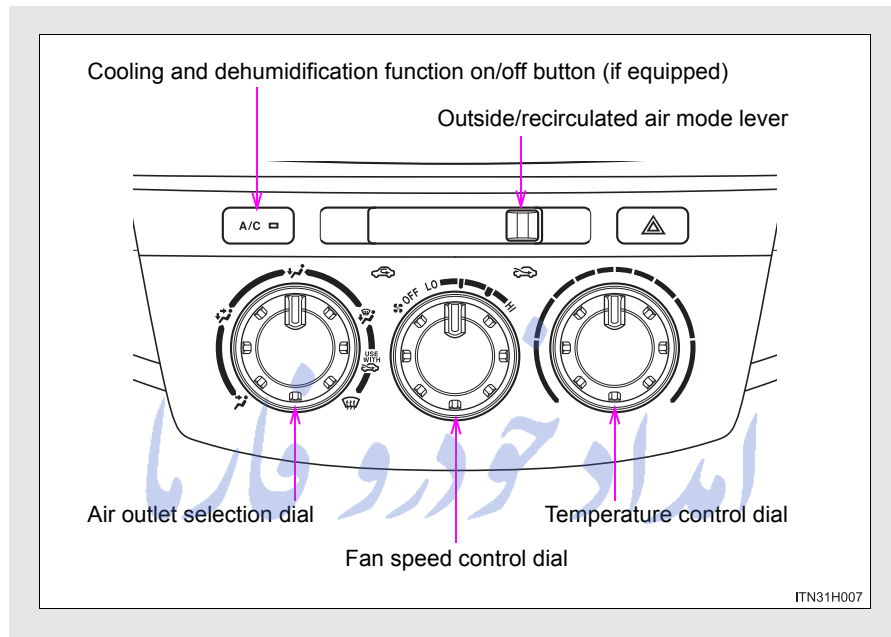

تلفن شبانه روزی: ۰۲۱-۸۸۶۲۰۸۵

FarmaSOS.com

\*: If equipped

### Adjusting the settings

**STEP 1** To adjust the fan speed, turn the fan speed control dial the clockwise (increase) or the counterclockwise (decrease).

Set the dial to "OFF" turns off the fan.

**STEP 2** To adjust the temperature setting, turn the temperature control dial clockwise (warm) or counterclockwise (cool).

If the "A/C" button is not pressed, the system will blow ambient temperature air or heated air. (if equipped)

**STEP 3** To select the air outlets, set the air outlet selection dial to the desired position.

The positions between the air outlet selections shown below can also be selected for more delicate adjustment.

### Defogging the windshield

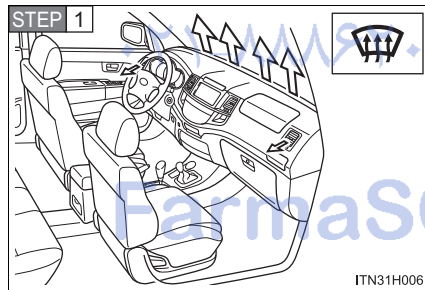

Set the air outlet selection dial to position.

Set the outside/recirculated air mode lever to outside mode if recirculated air mode is used.

**STEP 2** Perform the following operations accordingly:

- To adjust the fan speed, turn the fan speed control dial.
- To adjust the temperature setting, turn the temperature control dial.
- If the dehumidification function is not operating, press the "A/C" button to operate the dehumidification function.

To defog the windshield and the side windows early, turn the air flow and temperature up.

3-1. Using the air conditioning system and defogger

**Air outlets and air flow**

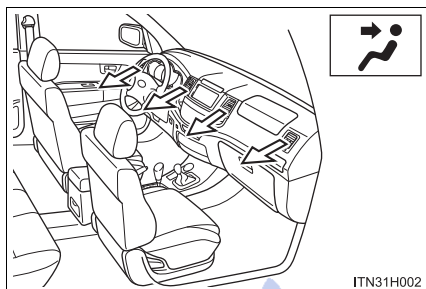

Air flows to the upper body.

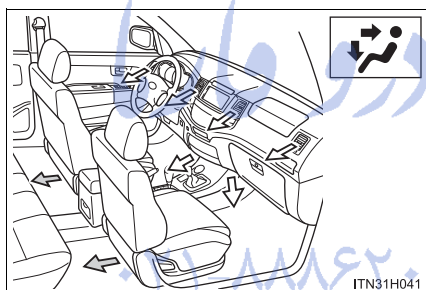

Air flows to the upper body and feet.

← : Some models

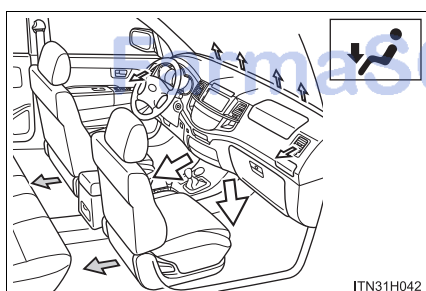

Air flows to the feet.

← : Some models

### 3-1. Using the air conditioning system and defogger

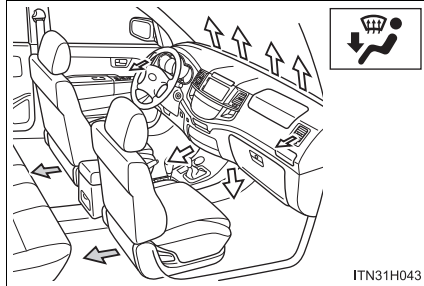



Air flows to the feet and the windshield defogger operates.

← : Some models

#### Switching between outside air and recirculated air modes

Move the outside/recirculated air mode lever.

The mode switches between  (introduces air from outside the vehicle) and  (recycles air inside the vehicle) each time the lever is moved.

#### Adjusting the position of and opening and closing the air outlets

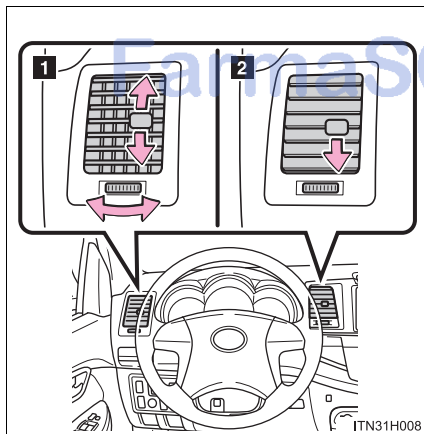

- 1 Direct air flow to the left or right, up or down.
- 2 Turn the knob to close the vent.

---

■ **Fogging up of the windows**

- The windows will easily fog up when the humidity in the vehicle is high. Turning the “A/C” button on will dehumidify the air from the outlets and defog the windshield effectively.
- If you turn the “A/C” button off, the windows may fog up more easily.
- The windows may fog up if the recirculated air mode is used.

■ **Outside/recirculated air mode**

When driving on dusty roads such as tunnels or in heavy traffic, set the outside/recirculated air mode lever to the recirculated air mode. This is effective in preventing outside air from entering the vehicle interior. During cooling operation, setting the recirculated air mode will also cool the vehicle interior effectively.

■ **When the outside temperature falls to nearly 0°C (32°F)**

The dehumidification function may not operate even when the “A/C” button is pressed.

■ **Air conditioning odors**

- During use, various odors from inside and outside the vehicle may enter into and accumulate in the air conditioning system. This may then cause odor to be emitted from the vents.
- To reduce potential odors from occurring:  
It is recommended that the air conditioning system be set to outside air mode prior to turning the vehicle off.

■ **Air conditioning filter**

→P. 511



### 3-1. Using the air conditioning system and defogger

#### CAUTION

##### ■ To prevent the windshield from fogging up

Do not use  during cool air operation in extremely humid weather. The difference between the temperature of the outside air and that of the windshield can cause the outer surface of the windshield to fog up, blocking your vision.

#### NOTICE

##### ■ To prevent battery discharge

Do not leave the air conditioning system on longer than necessary when the engine is stopped.

3

Interior features

تلفن شبانه روزی: ۰۲۱-۸۸۶۲۰۸۵

FarmaSOS.com

### 3-1. Using the air conditioning system and defogger Automatic air conditioning system\*

Air outlets and fan speed are automatically adjusted according to the temperature setting.

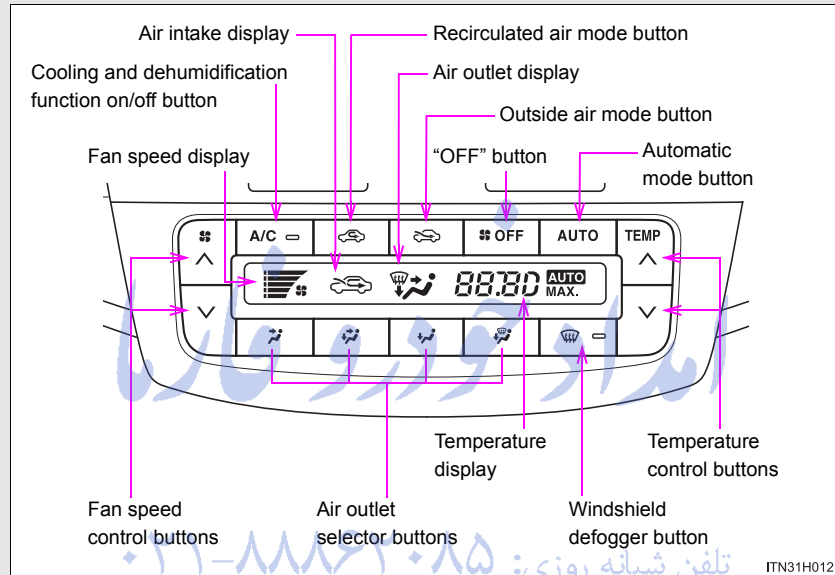



FarmaSOS.com

\*: If equipped

### Using the automatic air conditioning system

**STEP 1** Press the “AUTO” button.



The air conditioning system begins to operate. Air outlets and fan speed are automatically adjusted according to the temperature setting.

**STEP 2** Press  to increase the temperature and  to decrease the temperature.



**STEP 3** Press the “A/C” button.





The air cooling and dehumidification function switches between on and off each time the button is pressed.

### Adjusting the settings manually

**STEP 1** To adjust the fan speed, press  to increase the fan speed and  to decrease the fan speed.

Press the “OFF” button to turn the fan off.

**STEP 2** To adjust the temperature settings, press  to increase the temperature and  to decrease the temperature.

**STEP 3** To change the air outlets, press  ,  ,  or  .

### 3-1. Using the air conditioning system and defogger

#### Defogging the windshield

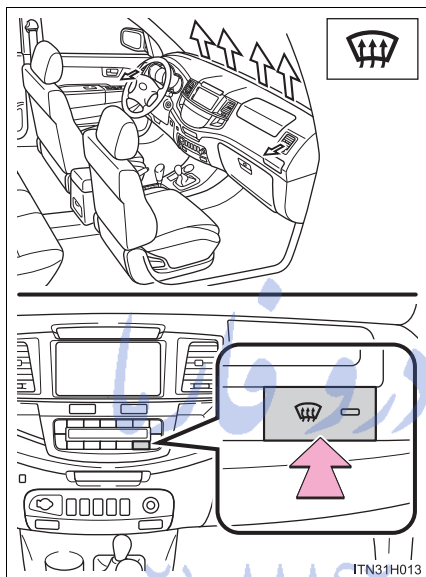

Press  .

The dehumidification function operates and fan speed increases.

Set the outside/recirculated air mode button to outside air mode if the recirculated air mode is used. (It may switch automatically.)

To defog the windshield and the side windows early, turn the air flow and temperature up.

To return to the previous mode, press  again when the windshield is defogged.

#### Air outlets and air flow

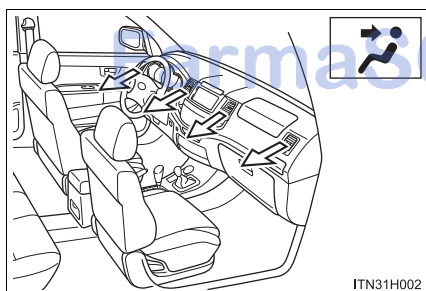

Air flows to the upper body.

3-1. Using the air conditioning system and defogger

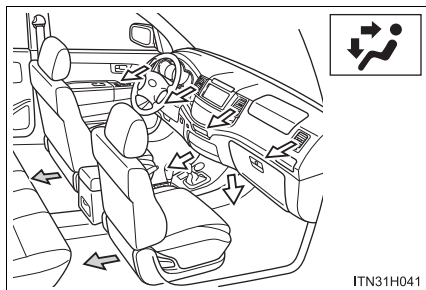

Air flows to the upper body and feet.

← : Some models

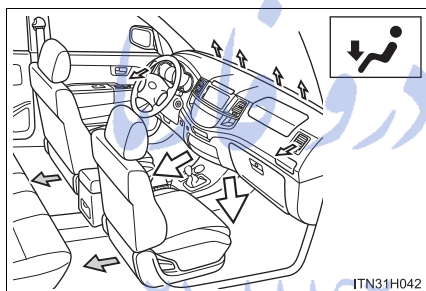

Air flows to the feet.

← : Some models

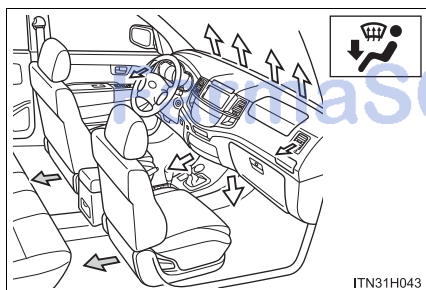



Air flows to the feet and the windshield defogger operates.

← : Some models

### 3-1. Using the air conditioning system and defogger

#### Switching between outside air and recirculated air modes

Press  to switch to recirculated air mode and press  to switch to outside air mode.

#### Adjusting the position of and opening and closing the air outlets

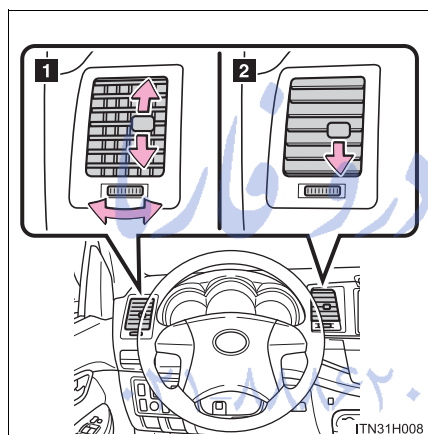

- 1 Direct air flow to the left or right, up or down.
- 2 Turn the knob to close the vent.

FarmaSOS.com

---

■ **Using automatic mode**

Fan speed is adjusted automatically according to the temperature setting and the ambient conditions.

Therefore, the fan may stop for a while until warm or cool air is ready to flow immediately after the “AUTO” button is pressed.

■ **Fogging up of the windows**

- The windows will easily fog up when the humidity in the vehicle is high. Turning the “A/C” button on will dehumidify the air from the outlets and defog the windshield effectively.
- If you turn the “A/C” button off, the windows may fog up more easily.
- The windows may fog up if the recirculated air mode is used.

■ **Outside/recirculated air mode**

- When driving on dusty roads such as tunnels or in heavy traffic, set the outside/recirculated air mode button to the recirculated air mode. This is effective in preventing outside air from entering the vehicle interior. During cooling operation, setting the recirculated air mode will also cool the vehicle interior effectively.
- Outside/recirculated air mode may automatically switch depending on the temperature setting or the inside temperature.

■ **When the outside temperature falls to nearly 0°C (32°F)**

The dehumidification function may not operate even when the “A/C” button is touched.

### 3-1. Using the air conditioning system and defogger

#### ■ Air conditioning odors

- During use, various odors from inside and outside the vehicle may enter into and accumulate in the air conditioning system. This may then cause odor to be emitted from the vents.
- To reduce potential odors from occurring:
  - It is recommended that the air conditioning system be set to outside air mode prior to turning the vehicle off.
  - The start timing of the blower may be delayed for a short period of time immediately after the air conditioning system is started in AUTO mode.

#### ■ Air conditioning filter

→P. 511

#### ⚠ CAUTION

##### ■ To prevent the windshield from fogging up

Do not use  during cool air operation in extremely humid weather. The difference between the temperature of the outside air and that of the windshield can cause the outer surface of the windshield to fog up, blocking your vision.

#### ⚠ NOTICE

##### ■ To prevent battery discharge

Do not leave the air conditioning system on longer than necessary when the engine is stopped.



### 3-1. Using the air conditioning system and defogger Power heater\*

This feature is used to keep the cabin warm in cold conditions.

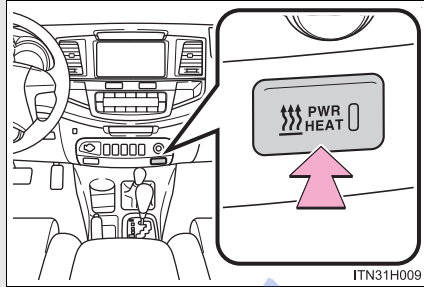

Turns the power heater on/off

If you do not turn the switch to off, the engine speed is increased whenever the engine is started.

- Power heater can be operated when  
The engine is running.

3

Interior features

تلفن شبانه روزی: ۰۲۱-۸۸۶۲۰۸۵

FarmaSOS.com

\*: If equipped

### 3-1. Using the air conditioning system and defogger Rear window defogger switch\*

Defoggers are used to defog the rear window, and to remove rain-drops, dew and frost from the outside rear view mirrors.

#### Vehicles without automatic air conditioning system

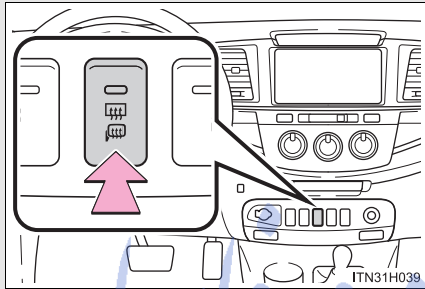

Turns the rear window and outside rear view mirror defoggers on/off

#### Vehicles with automatic air conditioning system

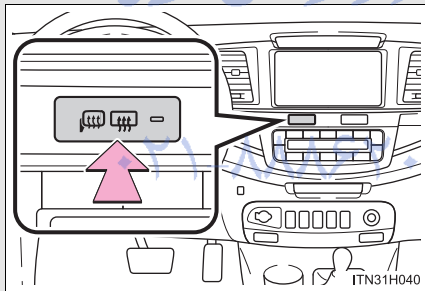

Turns the rear window and outside rear view mirror defoggers on/off

The defoggers will automatically turn off after approximately 15 minutes.

\*: If equipped

■ **The defoggers can be operated when**

The engine switch is in the "ON" position.

■ **The outside rear view mirror defoggers**

Turning the rear window defogger on will turn the outside rear view mirror defoggers on.

 **CAUTION**

■ **When the outside rear view mirror defoggers are on**

Do not touch the outside surface of the rear view mirrors, as they can become very hot and burn you.

تلفن شبانه روزی: ۰۲۱-۸۸۶۲۰۸۵

FarmaSOS.com

## 3-2. Using the audio system

### Audio system types\*

#### CD player with AM/FM radio

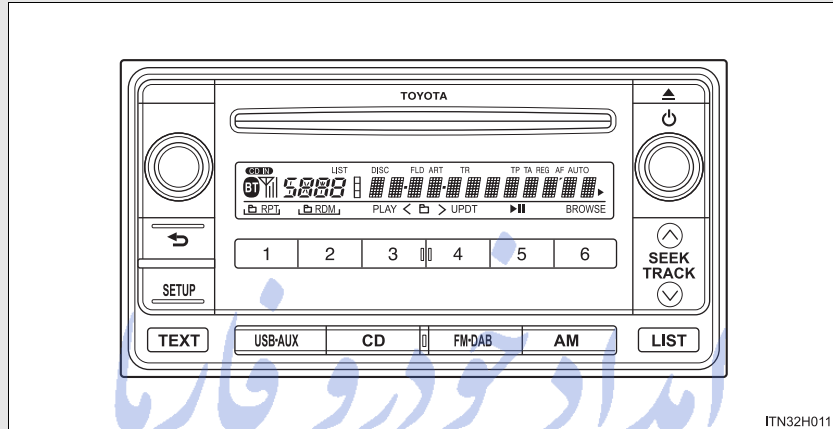

ITN32H011

Title	Page
Using the radio	P. 270
Using the CD player	P. 275
Playing MP3 and WMA discs	P. 282
Operating an iPod	P. 290
Operating a USB memory	P. 300
Optimal use of the audio system	P. 309
Using the AUX port	P. 313
Using the steering wheel audio switches	P. 314

\*: If equipped

■ **Using cellular phones**

Interference may be heard through the audio system's speakers if a cellular phone is being used inside or close to the vehicle while the audio system is operating.

 **CAUTION**

■ **Certification for the disc player**

This product is a class 1 laser product.

- A laser beam leak may result in hazardous radiation exposure.
- Do not open the cover of the player or attempt to repair the unit yourself. Refer servicing to qualified personnel.

 **NOTICE**

■ **To prevent battery discharge**

Do not leave the audio system on longer than necessary with the engine off.

■ **To avoid damaging the audio system**

Take care not to spill drinks or other fluids over the audio system.

## 3-2. Using the audio system

### Using the radio

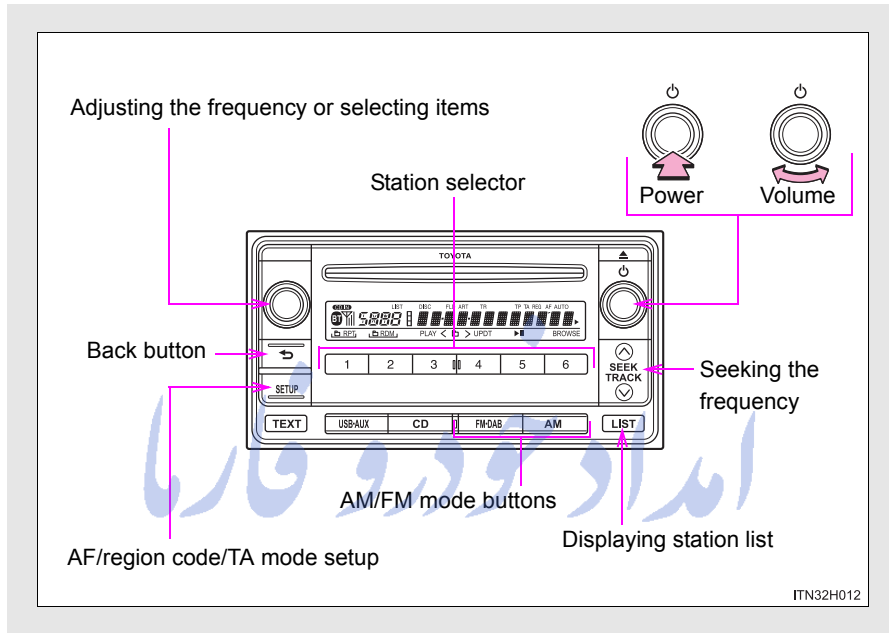

#### Setting station presets

- STEP 1** Search for the desired stations by turning , or pressing “^” or “v” on the “SEEK/TRACK” button.
- STEP 2** Press and hold the button (from the 1 button to the 6 button) the station is to be set to until you hear a beep.

### Using the station list

#### ■ Updating the station list

**STEP 1** Press the “LIST” button.

The station list will be displayed.

**STEP 2** Press the 4 (UPDT) button to update the list.

Available stations will be listed on the display.

To cancel the updating process, press  .

#### ■ Selecting a station from the station list

**STEP 1** Press the “LIST” button.

The station list will be displayed.

**STEP 2** Turn  to select a station.

**STEP 3** Press  to tune in the station.

To return to the previous display, press  .

FarmaSOS.com

### RDS (Radio Data System)

This feature allows your radio to receive station.

#### ■ Listening to stations of the same network

**STEP 1** Press the “SETUP” button.

**STEP 2** Turn  to “RADIO” and press .

**STEP 3** Turn  as corresponds to the desired mode: “FM AF” or “REG”.

**STEP 4** Press  to select “ON” or “OFF”.

“FM AF ON” mode: The station among those of the same network with strong reception is selected.

“REG ON” mode: The station among those of the same network with strong reception and broadcasting the same program is selected.

FarmaSOS.com



### ■ Traffic information

**STEP 1** Press the “SETUP” button.

**STEP 2** Turn  to “RADIO” and press .

**STEP 3** Turn  to “TA” mode.

**STEP 4** Press  to select “ON” or “OFF”.

“TP” mode: The system automatically switches to traffic information when a broadcast with a traffic information signal is received.

The station returns to the previous one when the traffic information ends.

“TA” mode: The system automatically switches to traffic information when a broadcast with a traffic information signal is received. In FM modes, the system will be mute unless traffic information is being broadcast.

The audio system returns to the previous mode when the traffic information ends.

FarmaSOS.com

■ **EON (Enhanced Other Network) system (for traffic announcement function)**

If the RDS station (with EON data) you are listening to is not broadcasting a traffic information program and the audio system is in the TA (traffic announcement) mode, the radio will be switched automatically to a station broadcasting a traffic information program in the EON AF list when traffic information begins.

■ **Reception sensitivity**

- It is difficult to maintain perfect radio reception at all times due to the continually changing position of the antenna, differences in signal strength and surrounding objects, such as trains and transmitters.
- The radio antenna is mounted on the roof. The antenna can be removed from the base by turning.

■ **Digital Audio Broadcast (DAB) radio**

The optional radio antenna and tuner are necessary for the use of Digital Audio Broadcast (DAB) radio.



**NOTICE**

■ **To prevent damage, retract the antenna in the following cases**

- The antenna will touch the ceiling of a garage.
- A cover will be put on the roof.
- When driving through an automatic car wash.
- Any other cases where there is a risk of touching surrounding parts.

### 3-2. Using the audio system Using the CD player

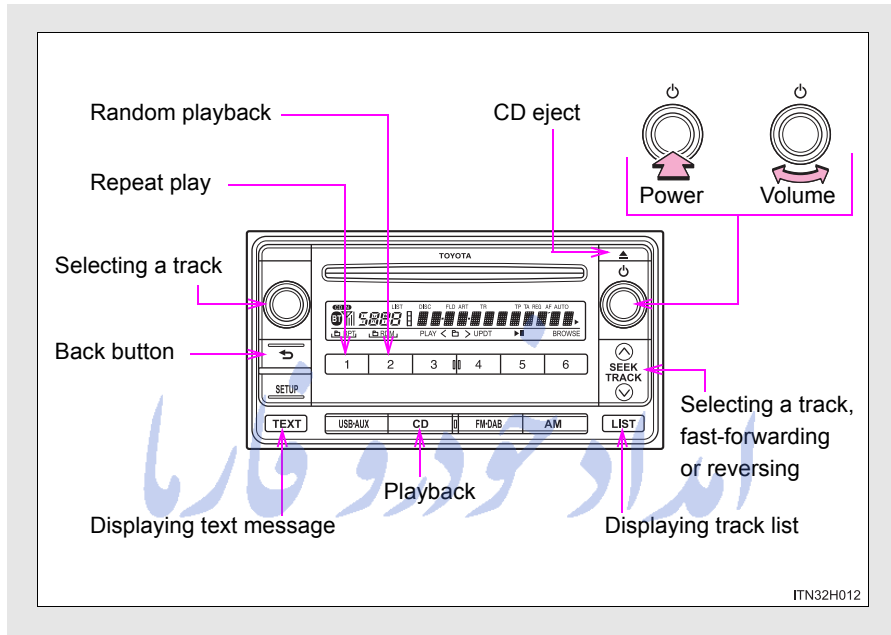

تلفن شبانه روزی: ۰۲۱-۸۸۶۲۰۸۵

FarmaSOS.com

3

Interior features

## 3-2. Using the audio system

### Loading a CD

Insert a CD.

### Ejecting a CD

Press  and remove the CD.

### Selecting a track

Turn , or press “^” to move up or “v” to move down using the “SEEK/TRACK” button until the desired track number is displayed.

### Selecting a track from a track list

**STEP 1** Press the “LIST” button.

The track list will be displayed.

**STEP 2** Turn and press  to select a track.

To return to the previous display, press  or the “LIST” button.

### Fast-forwarding and reversing tracks

To fast-forward or reverse, press and hold “^” or “v” on the “SEEK/TRACK” button.

### Random playback

Press the 2 (RDM) button.

Songs are played in random order.

To cancel, press the 2 (RDM) button again.

### Repeat play

Press the 1 (RPT) button.

To cancel, press the 1 (RPT) button again.

### Switching the display

Press the “TEXT” button.

Each time the button is pressed, the display changes in the following order: Track no./Elapsed time → CD title → Track title → Artist name

FarmaSOS.com

---

■ **CD player protection feature**

To protect the internal components, playback is automatically stopped when a problem is detected.

■ **Display**

Up to 12 characters can be displayed at a time.

If there are 13 or more characters, pressing and holding the “TEXT” button for 1 second or more enables to display the remaining characters.

A maximum of 24 characters can be displayed.

If the “TEXT” button is pressed for more than 1 second again or has not been operated for more than 6 seconds, the display will return to the first 12 characters.

Depending on the contents recorded, the characters may not be displayed properly or may not be displayed at all.

تلفن شبانه روزی: ۰۲۱-۸۸۶۲۰۸۵

FarmaSOS.com

■ **Error messages**

“ERROR”: This indicates a problem either in the CD or inside the player.

“CD CHECK”: The CD may be dirty, damaged or inserted up-side down.

“WAIT”: Operation has stopped due to a high temperature inside the player. Wait for a while and then press the “CD” button. Contact your Toyota dealer if the CD still cannot be played.

■ **Discs that can be used**

Discs with the marks shown below can be used.

Playback may not be possible depending on recording format or disc features, or due to scratches, dirt or deterioration.



CDs with copy-protect features may not be used.

■ **Lens cleaners**

Do not use lens cleaners. Doing so may damage the CD player.

■ **If discs are left inside the CD player or in the ejected position for extended periods of time**

The discs may be damaged and may not play properly.

FarmaSOS.com

 NOTICE

■ **CDs and adapters that cannot be used**

Do not use the following types of CDs, 8 cm (3 in.) CD adapters or Dual Disc.

Doing so may damage the CD player and/or the CD insert/eject function.

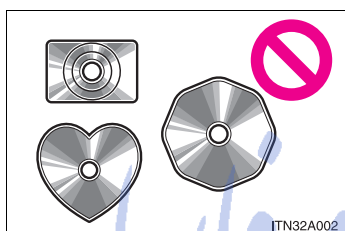

- CDs that have a diameter that is not 12 cm (4.7 in.)

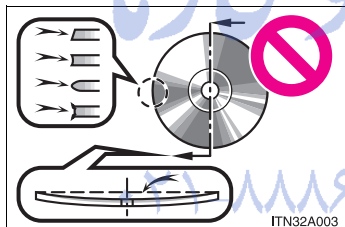

- Low-quality and deformed CDs

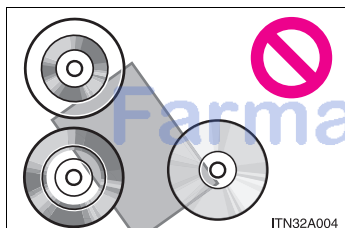

- CDs with a transparent or translucent recording area

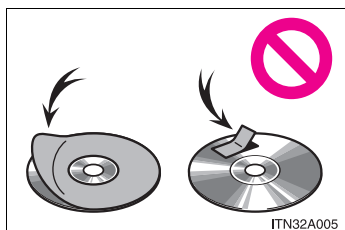

- CDs that have tape, stickers or CD-R labels attached to them, or that have had the label peeled off



 NOTICE

■ **CD player precautions**

Failure to follow the precautions below may result in serious damage to the CDs or the player itself.

- Do not insert anything other than CDs into the CD slot.
- Do not apply oil to the CD player.
- Store CDs away from direct sunlight.
- Never try to disassemble any part of the CD player.
- Do not insert more than one CD at a time.

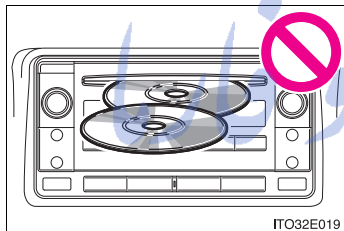

تلفن شبانه روزی: ۰۲۱-۸۸۶۲۰۸۵

FarmaSOS.com

### 3-2. Using the audio system Playing MP3 and WMA discs

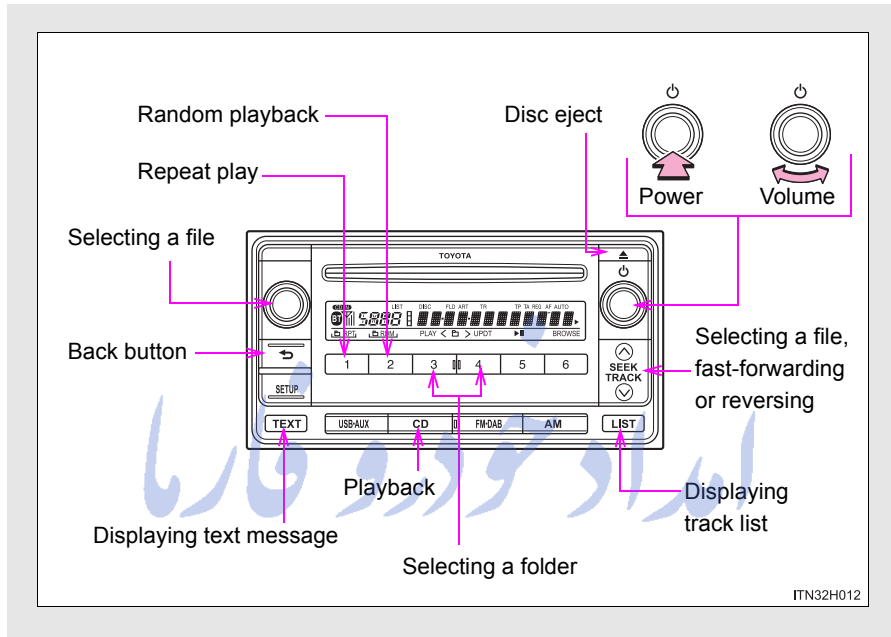

تلفن شبانه روزی: ۰۲۱-۸۸۶۲۰۸۵

FarmaSOS.com

**Loading and ejecting MP3 and WMA discs**

→P. 276

**Selecting a folder****■ Selecting a folder one at a time**

Press the 3 ( < ▢ ) or 4 ( ▢ > ) button to select the desired folder.

**■ Selecting a folder and file from folder lists**

**STEP 1** Press the “LIST” button.

The folder list will be displayed.

**STEP 2** Turn and press  to select a folder and a file.

To return to the previous display, press .

To exit, press the “LIST” button.

**■ Returning to the first folder**

Press and hold the 3 ( < ▢ ) button until you hear a beep.

**Fast-forwarding and reversing files**

To fast-forward or reverse, press and hold “^” or “v” on the “SEEK/TRACK” button.

**Selecting files**

Turn , or press “^” or “v” on the “SEEK/TRACK” button to select the desired file.

### Random playback

Pressing the 2 (RDM) button changes modes in the following order:

Folder random → Disc random → Off.



### Repeat play

Pressing the 1 (RPT) button changes modes in the following order:

File repeat → Folder repeat\* → Off.



\*: Available except when RDM (random playback) is selected

### Switching the display

Press the "TEXT" button.

Each time the button is pressed, the display changes in the following order: Track no./Elapsed time → Folder name → File name → Album title (MP3 only) → Track title → Artist name

FarmaSOS.com

■ **CD player protection feature**

→P. 278

■ **Display**

→P. 278

■ **Error messages**

“ERROR”: This indicates a problem either in the CD or inside the player.

“CD CHECK”: The CD may be dirty, damaged or inserted up-side down.

“WAIT”: Operation has stopped due to a high temperature inside the player. Wait for a while and then press the “CD” button. Contact your Toyota dealer if the CD still cannot be played.

“NO SUPPORT”: This indicates that the MP3/WMA file is not included in the CD.

تلفن شبانه روزی: ۰۲۱-۸۸۶۲۰۸۵

FarmaSOS.com

#### ■ Discs that can be used

Discs with the marks shown below can be used.  
Playback may not be possible depending on recording format or disc features, or due to scratches, dirt or deterioration.



#### ■ Lens cleaners

→P. 279

#### ■ If discs are left inside the CD player or in the ejected position for extended periods of time

→P. 279

#### ■ MP3 and WMA files

MP3 (MPEG Audio LAYER3) is a standard audio compression format.

Files can be compressed to approximately 1/10 of their original size by using MP3 compression.

WMA (Windows Media Audio) is a Microsoft audio compression format.

This format compresses audio data to a size smaller than that of the MP3 format.

There is a limit to the MP3 and WMA file standards that can be used and to the media/formats on which the files are recorded.

- MP3 file compatibility
  - Compatible standards  
MP3 (MPEG1 LAYER3, MPEG2 LSF LAYER3)
  - Compatible sampling frequencies  
MPEG1 LAYER3: 32, 44.1, 48 (kHz)  
MPEG2 LSF LAYER3: 16, 22.05, 24 (kHz)
  - Compatible bit rates (compatible with VBR)  
MPEG1 LAYER3: 64, 80, 96, 112, 128, 160, 192, 224, 256, 320 (kbps)  
MPEG2 LSF LAYER3: 64, 80, 96, 112, 128, 144, 160 (kbps)  
\*Compatible with VBR
  - Compatible channel modes: stereo, joint stereo, dual channel and monaural

- WMA file compatibility
  - Compatible standards  
WMA Ver. 7, 8, 9
  - Compatible sampling frequencies  
32, 44.1, 48 (kHz)
  - Compatible bit rates (only compatible with 2-channel playback)  
Ver. 7, 8: CBR 48, 64, 80, 96, 128, 160, 192 (kbps)  
Ver. 9: CBR 48, 64, 80, 96, 128, 160, 192, 256, 320 (kbps)  
\*Only compatible with 2-channel playback
- Compatible media  
Media that can be used for MP3 and WMA playback are CD-Rs and CD-RWs.  
Playback in some instances may not be possible if the CD-R or CD-RW is not finalized. Playback may not be possible or the audio may jump if the disc is scratched or marked with fingerprints.
- Compatible disc formats  
The following disc formats can be used:
  - Disc formats: CD-ROM Mode 1 and Mode 2  
CD-ROM XA Mode 2, Form 1 and Form 2
  - File formats: ISO9660 Level 1, Level 2, (Romeo, Joliet)  
MP3 and WMA files written in any format other than those listed above may not play correctly, and their file names and folder names may not be displayed correctly.
 Items related to standards and limitations are as follows:
  - Maximum directory hierarchy: 8 levels
  - Maximum length of folder names/file names: 32 characters
  - Maximum number of folders: 192 (including the root)
  - Maximum number of files per disc: 255

### 3-2. Using the audio system

- File names

The only files that can be recognized as MP3/WMA and played are those with the extension .mp3 or .wma.

- Discs containing multi-session recordings

As the audio system is compatible with multi-sessions, it is possible to play discs that contain MP3 and WMA files. However, only the first session can be played.

- ID3 and WMA tags

ID3 tags can be added to MP3 files, making it possible to record the track title, artist name, etc.

The system is compatible with ID3 Ver. 1.0, 1.1, and Ver. 2.2, 2.3 ID3 tags. (The number of characters is based on ID3 Ver. 1.0 and 1.1.)

WMA tags can be added to WMA files, making it possible to record the track title and artist name in the same way as with ID3 tags.

- MP3 and WMA playback

When a disc containing MP3 or WMA files is inserted, all files on the disc are first checked. Once the file check is finished, the first MP3 or WMA file is played. To make the file check finish more quickly, we recommend you do not write in any files other than MP3 or WMA files or create any unnecessary folders.

Discs that contain a mixture of music data and MP3 or WMA format data cannot be played.

- Extensions

If the file extensions .mp3 and .wma are used for files other than MP3 and WMA files, they will be mistakenly recognized and played as MP3 and WMA files. This may result in large amounts of interference and damage to the speakers.



- Playback

- To play an MP3 file with steady sound quality, we recommend a fixed bit rate of at least 128 kbps and a sampling frequency of 44.1 kHz.
- CD-R or CD-RW playback may not be possible in some instances, depending on the characteristics of the disc.
- There is a wide variety of freeware and other encoding software for MP3 and WMA files on the market, and depending on the status of the encoding and the file format, poor sound quality or noise at the start of playback may result. In some cases, playback may not be possible at all.
- When files other than MP3 or WMA files are recorded on a disc, it may take more time to recognize the disc and in some cases, playback may not be possible at all.
- Microsoft, Windows, and Windows Media are the registered trademarks of Microsoft Corporation in the U.S.A. and other countries.

 NOTICE

■ **CDs and adapters that cannot be used**

→P. 280

■ **CD player precautions**

→P. 281

FarmaSOS.com

### 3-2. Using the audio system

## Operating an iPod

Connecting an iPod enables you to enjoy music from the vehicle speakers.

#### ■ Connecting an iPod

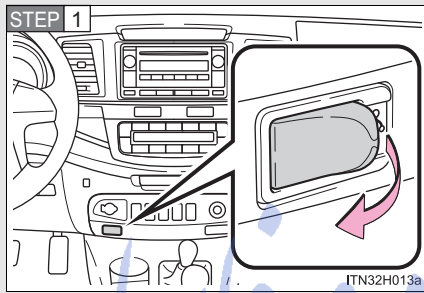

Open the cover and connect an iPod using an iPod cable.

Turn on the power of the iPod if it is not turned on.

STEP 2 Press the “USB•AUX” button.

تلفن شبانه روزی: ۰۲۱-۸۸۶۲۰۸۵

FarmaSOS.com

■ Control panel

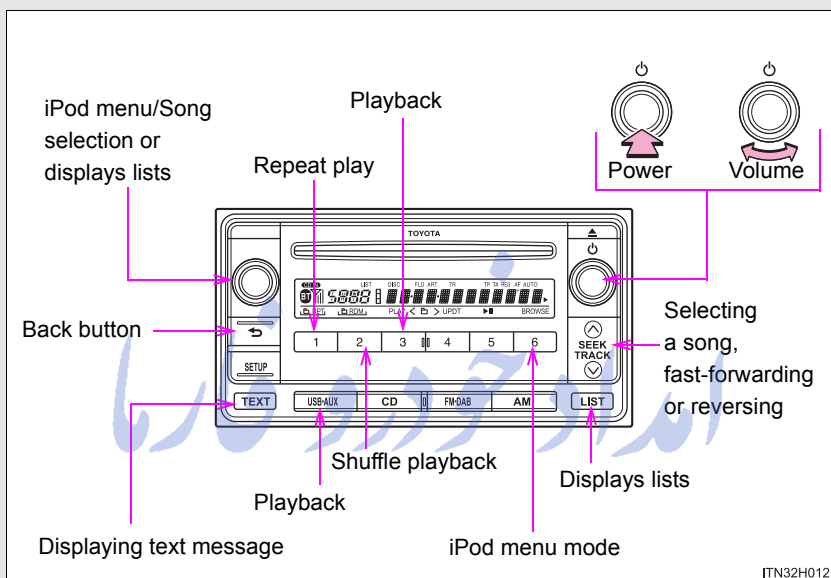

ITN32H012

3

Interior features

تلفن شبانه روزی: ۰۲۱-۸۸۶۲۰۸۵

FarmaSOS.com

## 3-2. Using the audio system

### Selecting a play mode

**STEP 1** Press the 6 (BROWSE) button to select iPod menu mode.

**STEP 2** Turning  changes the play mode in the following order:

“PLAYLISTS” → “ARTISTS” → “ALBUMS” → “SONGS” →  
“PODCASTS” → “GENRES” → “COMPOSERS” →  
“AUDIOBOOKS”

**STEP 3** Press  to select the desired play mode.

امداد خودرو فارما  
تلفن شبانه روزی: ۰۲۱-۸۸۸۶۲۰۸۵

FarmaSOS.com

### ■ Play mode list

Play mode	First selection	Second selection	Third selection	Fourth selection
"PLAYLISTS"	Playlists select	Songs select	-	-
"ARTISTS"	Artists select	Albums select	Songs select	-
"ALBUMS"	Albums select	Songs select	-	-
"SONGS"	Songs select	-	-	-
"PODCASTS"	Podcasts select	Episodes select	-	-
"GENRES"	Genre select	Artists select	Albums select	Songs select
"COMPOSERS"	Composers select	Albums select	Songs select	-
"AUDIOBOOKS"	Audiobooks select	Chapters select	-	-

### ■ Selecting a list

**STEP 1** Turn  to display the first selection list.

**STEP 2** Press  to select the desired item.

Pressing the knob changes to the second selection list.

**STEP 3** Repeat the same procedure to select the desired song name.

To return to the previous selection list, press  .

## 3-2. Using the audio system

### Selecting songs

Turn , or press “^” or “v” on the “SEEK/TRACK” button to select the desired song.

### Selecting a song from the song list

**STEP 1** Press the “LIST” button.

The song list will be displayed.

**STEP 2** Turn  to select a song.

**STEP 3** Press  to play the song.

To return to the previous display, press .

### Playing songs

To play a song, press the 3 (PLAY) button.

### Fast-forwarding and rewinding songs

To fast-forward or rewind, press and hold “^” or “v” on the “SEEK/TRACK” button.

**Shuffle playback**

Pressing the 2 (RDM) button changes modes in the following order:

Track shuffle → Album shuffle → Off.

**Repeat play**

Press the 1 (RPT) button.

To cancel, press the 1 (RPT) button again.

**Switching the display**

Press the "TEXT" button.

Each time the button is pressed, the display changes in the following order: Track no./Elapsed time → Album title → Track title → Artist name

**Adjusting sound quality and volume balance**

**STEP 1** Press the "SETUP" button to enter iPod menu mode.

**STEP 2** Turning  changes sound modes. (→P. 309)

---

■ **About iPod**



- “Made for iPod” and “Made for iPhone” mean that an electronic accessory has been designed to connect specifically to iPod, or iPhone, respectively, and has been certified by the developer to meet Apple performance standards.
- Apple is not responsible for the operation of this device or its compliance with safety and regulatory standards. Please note that the use of this accessory with iPod or iPhone may affect wireless performance.
- iPhone, iPod, iPod classic, iPod nano and iPod touch are trademarks of Apple Inc., registered in the U.S. and other countries.

■ **iPod functions**

- When an iPod is connected and the audio source is changed to iPod mode, the iPod will resume play from the same point in which it was last used.
- Depending on the iPod that is connected to the system, certain functions may not be available. Disconnecting the device and reconnecting it once again may resolve some malfunctions.
- While connected to the system, the iPod cannot be operated with its own controls. It is necessary to use the controls of the vehicle’s audio system instead.

■ **iPod problems**

To resolve most problems encountered when using your iPod, disconnect your iPod from the vehicle iPod connection and reset it. For instructions on how to reset your iPod, refer to your iPod Owner’s Manual.



■ **Display**

→P. 278

■ **Error messages**

- "ERROR 1": This indicates that the data in the iPod cannot be read.
- "ERROR 3": This indicates that the iPod may be malfunctioning.
- "ERROR 4": This indicates that an over current error has occurred.
- "ERROR 5": This indicates that an iPod communication error has occurred.
- "ERROR 6": This indicates that an authentication error has occurred.
- "NO SONGS": This indicates that there is no music data in the iPod.
- "NO PLAYLISTS": This indicates that some available songs are not found in a selected playlist.
- "UPDATE": This indicates that the version of the iPod is not compatible. Upgrade your iPod software to the latest version.

تلفن شبانه روزی: ۰۲۱-۸۸۶۲۰۸۵

FarmaSOS.com

## 3-2. Using the audio system

### ■ Compatible models

The following iPod®, iPod nano®, iPod classic®, iPod touch® and iPhone® devices can be used with this system.

- Made for
  - iPod touch (4th generation)
  - iPod touch (3rd generation)
  - iPod touch (2nd generation)
  - iPod touch (1st generation)
  - iPod classic
  - iPod with video
  - iPod nano (6th generation)
  - iPod nano (5th generation)
  - iPod nano (4th generation)
  - iPod nano (3rd generation)
  - iPod nano (2nd generation)
  - iPod nano (1st generation)
  - iPhone 4
  - iPhone 3GS
  - iPhone 3G
  - iPhone

Depending on differences between models or software versions etc., some models might be incompatible with this system.

Items related to standards and limitations are as follows:

- Maximum number of lists in device: 9999
- Maximum number of songs in device: 65535
- Maximum number of songs per list: 65535

 **CAUTION**

■ **Caution while driving**

Do not connect iPod or operate the controls.

 **NOTICE**

■ **To prevent damage to iPod**

- Do not leave iPod in the vehicle. The temperature inside the vehicle may become high, resulting in damage to the player.
- Do not push down on or apply unnecessary pressure to the iPod while it is connected as this may damage the iPod or its terminal.
- Do not insert foreign objects into the port as this may damage the iPod or its terminal.

تلفن شبانه روزی: ۰۲۱-۸۸۶۲۰۸۵

FarmaSOS.com

### 3-2. Using the audio system

## Operating a USB memory

Connecting a USB memory enables you to enjoy music from the vehicle speakers.

#### ■ Connecting a USB memory

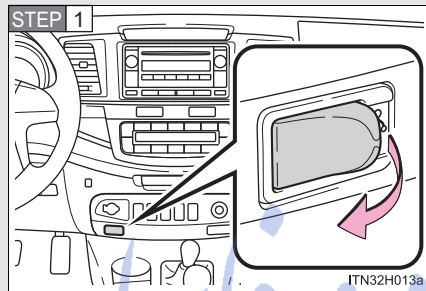

Open the cover and connect a USB memory.

Turn on the power of the USB memory if it is not turned on.

**STEP 2** Press the “USB•AUX” button.

تلفن شبانه روزی: ۰۲۱-۸۸۶۲۰۸۵

FarmaSOS.com

■ Control panel

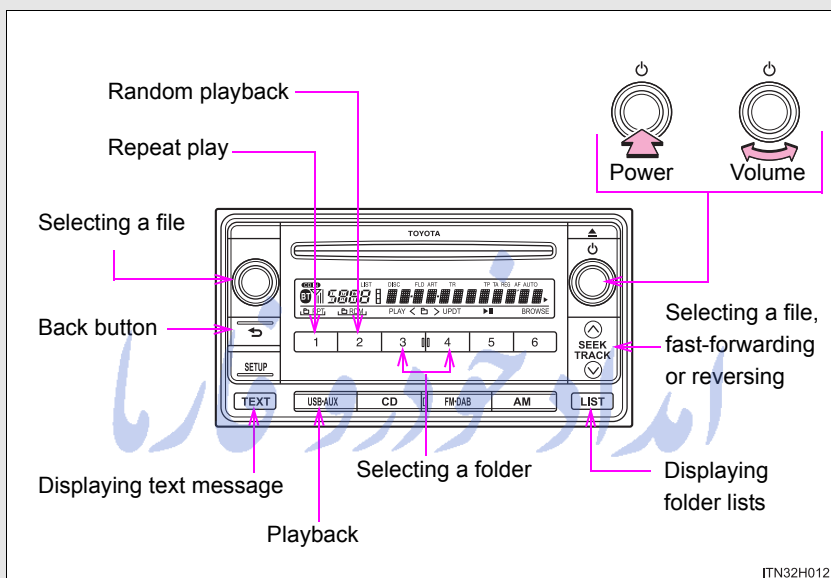

3

Interior features

FarmaSOS.com

### Selecting a folder

#### ■ Selecting folders one at a time

Press the 3 ( < ▢ ) or 4 ( ▢ > ) button to select the desired folder.

#### ■ Selecting a folder and a file from folder lists

**STEP 1** Press the “LIST” button.

The folder list will be displayed.

**STEP 2** Turn and press  to select a folder and a file.

To return to the previous display, press the .

#### ■ Returning to the first folder

Press and hold the 3 ( < ▢ ) button until you hear a beep.

تلفن شبانه روزی: ۰۲۱-۸۸۶۲۰۸۵

FarmaSOS.com

### Selecting files

Turn  or press “^” or “v” on the “SEEK/TRACK” button to select the desired file.

### Fast-forwarding and rewinding files

To fast-forward or rewind, press and hold “^” or “v” on the “SEEK/TRACK” button.

### Random playback

Pressing the 2 (RDM) button changes modes in the following order:  
Folder random → Disc random → Off.



تلفن شبانه روزی: ۰۲۱-۸۸۶۲۰۸۵

FarmaSOS.com

### Repeat play

Pressing the 1 (RPT) button changes modes in the following order:

File repeat → Folder repeat\* → Off.



\*: Available except when RDM (random playback) is selected

### Switching the display

Press the “TEXT” button.

Each time the button is pressed, the display changes in the following order: Track no./Elapsed time → Folder name → File name → Album title (MP3 only) → Track title → Artist name

#### ■ USB memory functions

- Depending on the USB memory that is connected to the system, the device itself may not be operable and certain functions may not be available. If the device is inoperable or a function is unavailable due to a malfunction (as opposed to a system specification), disconnecting the device and reconnecting it once again may resolve the problem.
- If the USB memory still does not begin operation after being disconnected and reconnected, format the memory.

#### ■ Display

→P. 278



### ■ Error messages

“ERROR”: This indicates a problem in the USB memory or its connection.

“NO MUSIC”: This indicates that no MP3/WMA files are included in the USB memory.

### ■ USB memory

#### ● Compatible devices

USB memory that can be used for MP3 and WMA playback

#### ● Compatible device formats

The following device formats can be used:

- USB communication formats: USB2.0 FS (12mbps)
- File formats: FAT12/16/32 (Windows)
- Correspondence class: Mass storage class

MP3 and WMA files written in any format other than those listed above may not play correctly, and their file names and folder names may not be displayed correctly.

Items related to standards and limitations are as follows:

- Maximum directory hierarchy: 8 levels
- Maximum number of folders in a device: 999 (including the root)
- Maximum number of files in a device: 9999
- Maximum number of files per folder: 255

#### ● MP3 and WMA files

MP3 (MPEG Audio LAYER 3) is a standard audio compression format.

Files can be compressed to approximately 1/10 of their original size using MP3 compression.

WMA (Windows Media Audio) is a Microsoft audio compression format.

This format compresses audio data to a size smaller than that of the MP3 format.

There is a limit to the MP3 and WMA file standards that can be used and to the media/formats on which the files are recorded.

### 3-2. Using the audio system

- MP3 file compatibility
  - Compatible standards  
MP3 (MPEG1 AUDIO LAYERII, III, MPEG2 AUDIO LAYERII, III, MPEG2.5)
  - Compatible sampling frequencies  
MPEG1 AUDIO LAYERII, III: 32, 44.1, 48 (kHz)  
MPEG2 AUDIO LAYERII, III: 16, 22.05, 24 (kHz)  
MPEG2.5: 8, 11.025, 12 (kHz)
  - Compatible bit rates (compatible with VBR)  
MPEG1 AUDIO LAYERII, III: 32-320 (kbps)  
MPEG2 AUDIO LAYERII, III: 32-160 (kbps)  
MPEG2.5: 32-160 (kbps)
  - Compatible channel modes: stereo, joint stereo, dual channel and monaural
- WMA file compatibility
  - Compatible standards  
WMA Ver. 7, 8, 9
  - Compatible sampling frequencies  
HIGH PROFILE 32, 44.1, 48 (kHz)
  - Compatible bit rates  
HIGH PROFILE 32-320 (kbps, VBR)
- File names

The only files that can be recognized as MP3/WMA and played are those with the extension .mp3 or .wma.

FarmaSOS.com

- ID3 and WMA tags

ID3 tags can be added to MP3 files, making it possible to record the track title, artist name, etc.

The system is compatible with ID3 Ver. 1.0, 1.1, and Ver. 2.2, 2.3, 2.4 ID3 tags. (The number of characters is based on ID3 Ver. 1.0 and 1.1.)

WMA tags can be added to WMA files, making it possible to record the track title and artist name in the same way as with ID3 tags.

- MP3 and WMA playback

- When a device containing MP3 or WMA files is connected, all files in the USB memory device are checked. Once the file check is finished, the first MP3 or WMA file is played. To make the file check finish more quickly, we recommend that you do not include any files other than MP3 or WMA files or create any unnecessary folders.

- When the USB device is connected and the audio source is changed to USB memory mode, the USB device will start playing the first file in the first folder. If the same device is removed and reinserted (and the contents have not been changed), the USB device will resume play from the same point in which it was last used.

- Extensions

If the file extensions .mp3 and .wma are used for files other than MP3 and WMA files, they will be skipped (not played).

FarmaSOS.com

### 3-2. Using the audio system

#### ● Playback

- To play MP3 files with steady sound quality, we recommend a fixed bit rate of at least 128 kbps and a sampling frequency of 44.1 kHz.
- There is a wide variety of freeware and other encoding software for MP3 and WMA files on the market, and depending on the status of the encoding and the file format, poor sound quality or noise at the start of playback may result. In some cases, playback may not be possible at all.
- Microsoft, Windows, and Windows Media are registered trademarks of Microsoft Corporation in the U.S.A. and other countries.

#### CAUTION

##### ■ Caution while driving

Do not connect USB memory or operate the controls.

#### NOTICE

##### ■ To prevent damage to USB memory

- Do not leave USB memory in the vehicle. The temperature inside the vehicle may become high, resulting in damage to the player.
- Do not push down on or apply unnecessary pressure to the USB memory while it is connected as this may damage the USB memory or its terminal.
- Do not insert foreign objects into the port as this may damage the USB memory or its terminal.

### 3-2. Using the audio system

## Optimal use of the audio system

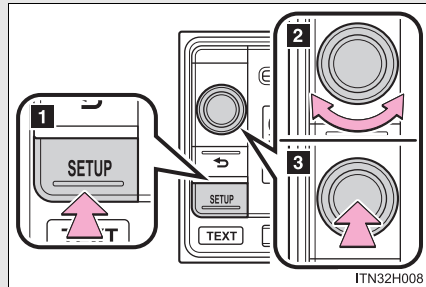

- 1** Displays the current mode
- 2** Changes the following settings
  - Sound quality and volume balance  
→P. 311  
The sound quality and balance setting can be changed to produce the best sound.
  - Automatic Sound Levelizer on/off  
→P. 312
- 3** Selecting the mode

تلفن شبانه روزی: ۰۲۱-۸۸۶۲۰۸۵

FarmaSOS.com

### Using the audio control function

#### ■ Changing sound quality modes

**STEP 1** Press the “SETUP” button.

**STEP 2** Turn  to select “SOUND”.

**STEP 3** Press .

**STEP 4** Turn  as corresponds to the desired mode.

“BAS”, “TRE”, “FAD”, “BAL”, or “ASL”

**STEP 5** Press .

تلفن شبانه روزی: ۰۲۱-۸۸۶۲۰۸۵

FarmaSOS.com

### ■ Adjusting sound quality

Turning  adjusts the level.

Mode displayed	Sound quality mode	Level	Turn counterclockwise	Turn clockwise
"BAS"*1	Bass	-5 to 5	Low	High
"TRE"*1	Treble	-5 to 5		
"FAD"*2	Front/rear volume balance	F7 to R7	Shifts to rear	Shifts to front
"BAL"	Left/right volume balance	L7 to R7	Shifts to left	Shifts to right

\*1: The sound quality level is adjusted individually in each audio mode.

\*2: For vehicles equipped with two speakers, no sound will be emitted if R7 is selected.

تلفن شبانه روزی: ۰۲۱-۸۸۶۲۰۸۵

FarmaSOS.com

■ **Adjusting the Automatic Sound Levelizer (ASL)**

When ASL is selected, turning  clockwise changes the amount of ASL in the order of LOW, MID, HIGH and OFF.

ASL automatically adjusts the volume and tone quality according to vehicle speed.

---

■ **Trademark owned by SRS Labs, Inc. (type A)**



The audio systems utilize SRS FOCUS<sup>®</sup> and SRS TruBass<sup>®</sup> audio enhancement technologies, under license from SRS Labs, Inc., in all mode except AM radio mode.

- FOCUS, TruBass, SRS and  symbol are trademarks of SRS Labs, Inc. FOCUS and TruBass technologies are incorporated under license from SRS Labs, Inc.
- SRS FOCUS<sup>®</sup> raises the audio image from non-optimally placed speakers up to the natural listening height at ear level. SRS TruBass<sup>®</sup> enhances the perception of bass frequencies to provide deep, rich bass response from any size speaker.



## 3-2. Using the audio system Using the AUX port

This port can be used to connect a portable audio device and listen to it through the vehicle's speakers.

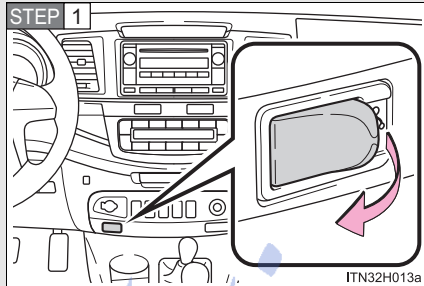

Open the cover and connect the portable audio device

**STEP 2** Press the "USB•AUX" button.

### ■ Operating portable audio devices connected to the audio system

The volume can be adjusted using the vehicle's audio controls. All the other adjustments must be made on the portable audio device itself.

### ■ When using a portable audio device connected to the power outlet

Noise may occur during playback. Use the power source of the portable audio device.

FarmaSOS.com

### 3-2. Using the audio system

## Using the steering wheel audio switches\*

Some audio features can be controlled using the switches on the steering wheel.

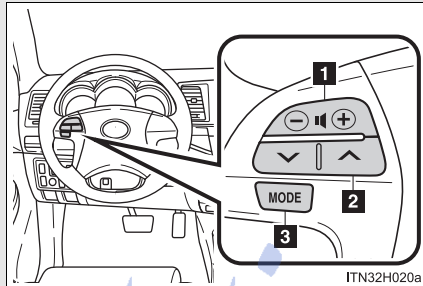

**1** Increases/decreases volume

**2** Radio mode:

Selects a radio station

CD mode: Selects a track, file (MP3 and WMA)

iPod mode: Selects a song

USB memory mode:

Selects a file and folder

**3** Turns the power on, selects an audio source

FarmaSOS.com

\*: If equipped

#### Turning the power on

Press the “MODE” button when the audio system is turned off.

#### Changing the audio source

Press the “MODE” button when the audio system is turned on. The audio source changes as follows each time the button is pressed.

AM → FM1 → DAB → CD mode →  
iPod or USB memory mode → AUX → AM

#### Adjusting the volume

Press “+” on  to increase the volume and “-” to decrease the volume.

Hold down the button to continue increasing or decreasing the volume.

#### Silencing a sound

Press and hold the “MODE” button.

To cancel, press and hold the “MODE” button.

FarmaSOS.com

## 3-2. Using the audio system

### Selecting a radio station

**STEP 1** Press the “MODE” button to select the radio mode.

**STEP 2** Press “^” or “v” on  to select a radio station.

To scan for receivable stations, press and hold “^” or “v” on the button until you hear a beep.

### Selecting a track/file or song

**STEP 1** Press the “MODE” button to select CD, iPod or USB memory mode.

**STEP 2** Press “^” or “v” on  to select the desired track/file or song.

### Selecting a folder

**STEP 1** Press the “MODE” button to select CD or USB memory mode.

**STEP 2** Press and hold “^” or “v” on  until you hear a beep.

### CAUTION

#### ■ To reduce the risk of an accident

Exercise care when operating the audio switches on the steering wheel.

### 3-3. Using the “touch screen”

## Touch screen

By touching the screen with your finger, you can control the audio system and hands-free system, etc.

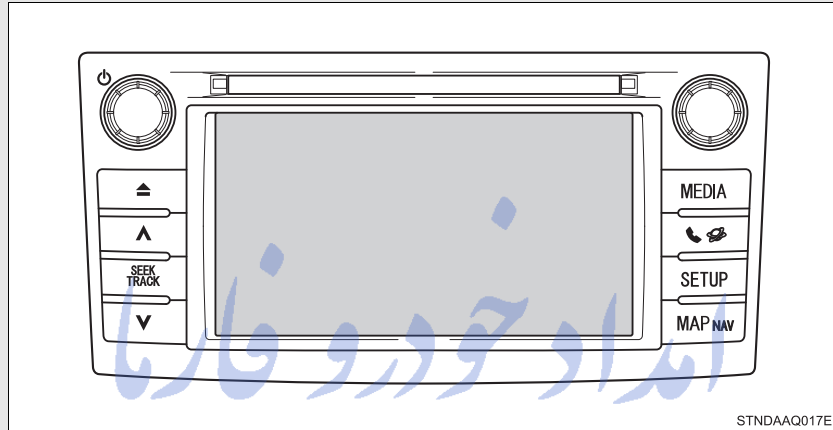

STNDAAQ017E

This illustration is for left-hand drive vehicle.

Button	Function
“MEDIA”	Audio system (→P. 327)
“☎”	Hands-free system (→P. 387)
“SETUP”	Setup menu (→P. 319)
“MAP NAV”	Add-on external system with functions such as a navigation system

3

Interior features

### 3-3. Using the “touch screen”

#### ■ When using the touch screen

- If the screen is cold, the display may be dark, or the system may seem to be operating slightly slower than normal.
- The screen may seem dark and hard to see when viewed through sunglasses. Change your angle of viewing, adjust the display on the “Display settings” screen (→P. 322) or remove your sunglasses.

#### NOTICE

#### ■ To avoid damaging the touch screen

- To prevent damaging the screen, lightly touch the screen buttons with your finger.
- Do not use objects other than your finger to touch the screen.
- Wipe off fingerprints using a glass cleaning cloth. Do not use chemical cleaners to clean the screen, as they may damage the touch screen.

تلفن شبانه روزی: ۰۲۱-۸۸۶۲۰۸۵

FarmaSOS.com

### 3-3. Using the “touch screen” Setup menu

You can change the “touch screen” to your desired setting.  
Press “SETUP” to display the “Setup” screen.

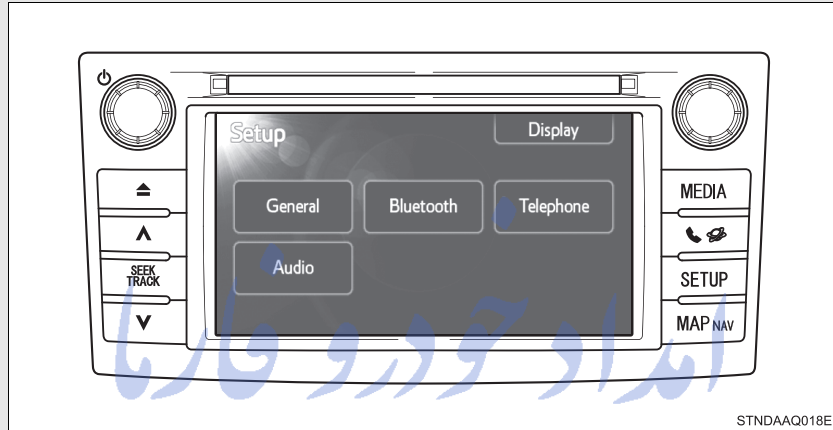

Switch	Page
“General”	P. 320
“Display”	P. 322
“Bluetooth*”	P. 428
“Telephone”	P. 411
“Audio”	P. 324

\*: Bluetooth is a registered trademark of Bluetooth SIG. Inc.

### 3-3. Using the “touch screen”

#### General settings

This screen is used for various settings such as language selection and setting operation sounds.

**STEP 1** Press “SETUP”.

**STEP 2** Touch “General” on the “Setup” screen.

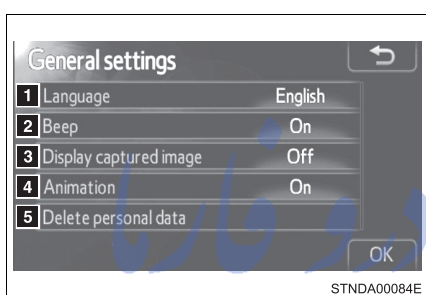

**1** Select language (→P. 321)

**2** Beep on/off

**3** Display captured image on/off

“On” or “Off” can be selected to display captured image/iPod cover art in the screen.

**4** Animation on/off

The animation effect for audio source selection screen can be set to “On” or “Off”.

**5** Personal data can be deleted. (→P. 321)

**STEP 3** When you complete settings, touch “OK”.

FarmaSOS.com



■ **Selecting a language**

**STEP 1** Touch "Language" on the "General settings" screen.



Select the desired language.

The desired one of the 7 languages can be selected.

**STEP 3** Touch "OK".

■ **Delete personal data**

**STEP 1** Touch "Delete personal data" on the "General settings" screen.

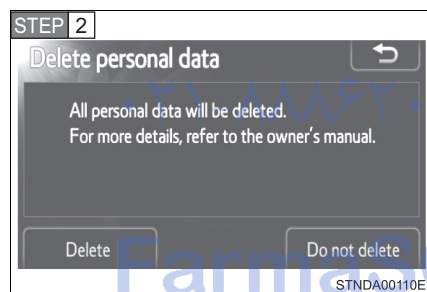

Touch "Delete".

Check carefully beforehand, as data cannot be retrieved once deleted.

### 3-3. Using the “touch screen”

**STEP 3** A confirmation screen will be displayed. Touch “Yes”.

The following personal data can be deleted or turned to their default settings.

- Phonebook data
- Call history data
- Speed dial data
- Bluetooth® devices data
- Phone sound settings
- Detailed Bluetooth® settings
- Audio settings

#### Display settings

**STEP 1** Press “SETUP”.

**STEP 2** Touch “Display” on the “Setup” screen.

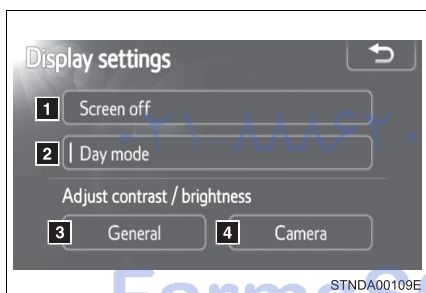

#### 1 Turn off screen

The screen is turned off. To turn it on, press any button such as “MEDIA” or “SETUP”.

#### 2 Change to day mode (→P. 323)

#### 3 Adjust screen contrast/brightness (→P. 323)

#### 4 Adjust screen contrast/brightness of rear view monitor camera (→P. 323)

■ **Changing between day mode and night mode**

When the headlights are turned on, the screen dims.  
 However, the screen can be switched to day mode by touching "Day mode".

The screen will stay in day mode when the headlights are turned on until "Day mode" is touched again.

■ **Adjusting the screen contrast/brightness**

**STEP 1** Touch "General" or "Camera" on the "Display settings" screen.

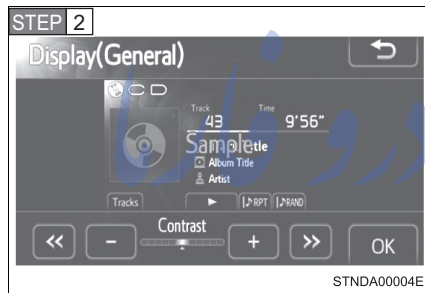

Adjust the display as desired using "+" or "-".

Select "Contrast" or "Brightness" using the "<<" or ">>".

	" "	" + "
"Contrast"	Weaker	Stronger
"Brightness"	Darker	Brighter

**STEP 3** Touch "OK".

### 3-3. Using the "touch screen"

#### Audio settings

**STEP 1** Press "SETUP".

**STEP 2** Touch "Audio" on the "Setup" screen.

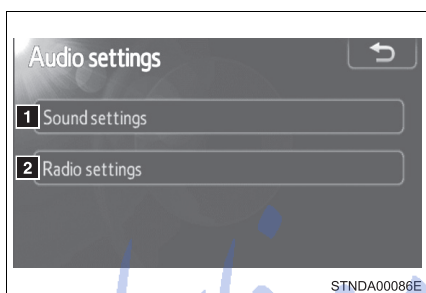

**1** Adjust sound settings  
(→P. 324)

**2** Radio settings (→P. 326)

#### ■ Adjust sound settings

**STEP 1** Touch "Sound settings" on the "Audio settings" screen.

#### "Sound" tab

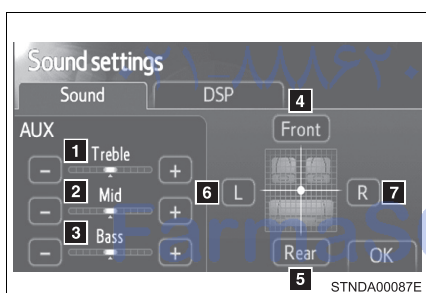

**1 2 3** Touch "-" or "+" to adjust the treble, mid or bass to a level between -5 to 5.

**4 5** Touch "Front" or "Rear" to adjust the front/rear audio balance to a level between Front 7 and Rear 7.

**6 7** Touch "L" or "R" to adjust the left/right audio balance to a level between L7 and R7.

### "DSP" tab

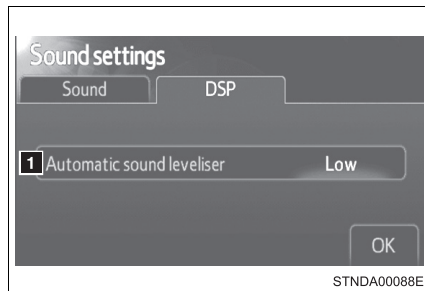

#### 1 Automatic sound levelizer (ASL)

Adjust the ASL level in the order of "High", "Mid", "Low" or "Off".

**STEP 2** When you complete settings, touch "OK".

#### ■ The sound quality level is adjusted individually

The treble, mid and bass levels can be adjusted for the each audio mode separately.

#### ■ About Automatic Sound Leveliser (ASL)

ASL automatically adjusts the volume and tone quality according to the vehicle speed.

تلفن شبانه روزی: ۰۲۱-۸۸۶۲۰۸۵

FarmaSOS.com

### 3-3. Using the “touch screen”

#### ■ Radio settings

**STEP 1** Touch “Radio settings” on the “Audio settings” screen.

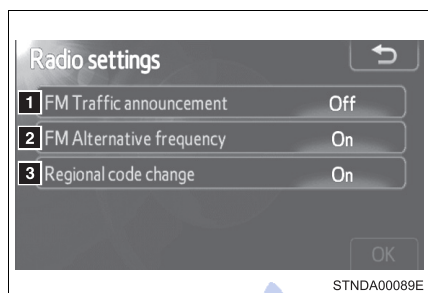

**1** FM Traffic announcement on/off

The system automatically switches to traffic information when a broadcast with a traffic information signal is received.

**2** FM Alternative frequency on/off

The station among those of the same network with strong reception is selected.

**3** Regional code change on/off

The station among those of the same network with strong reception and broadcasting the same program is selected.

**STEP 2** When you complete settings, touch “OK”.

FarmaSOS.com

### 3-3. Using the “touch screen” Audio system

Press “MEDIA” to display the audio control screen.

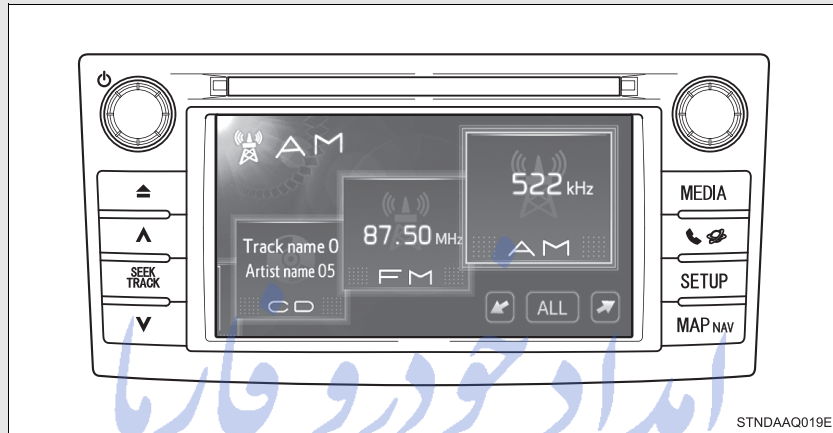

Title	Page
Using the radio	P. 331
Using the CD player	P. 336
Playing an audio CD and MP3/WMA discs	P. 337
Listening to an iPod	P. 350
Listening to a USB memory	P. 360
Using the AUX port	P. 369
Listening to Bluetooth® audio	P. 370
Using the steering wheel audio switches	P. 384

### 3-3. Using the "touch screen"

#### Switching the audio source

**STEP 1** Press "MEDIA" to display audio control screen.



Touch "Source" or press "MEDIA" to display the audio source selection screen.

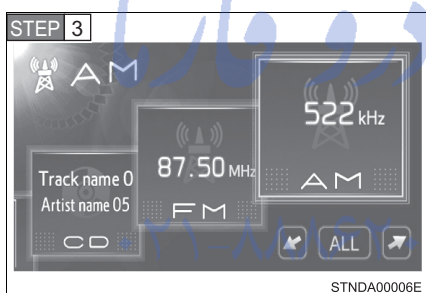

Touch the desired audio source.

  : To scroll the screen.

**ALL** : Change to the list style screen as follows.

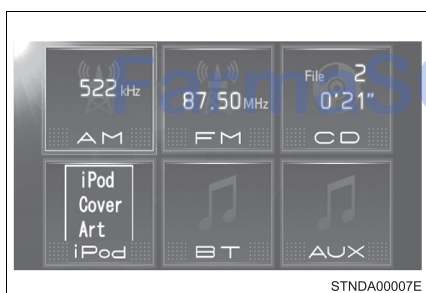



### List screen operation

When a list is displayed, use the appropriate button to scroll through the list.

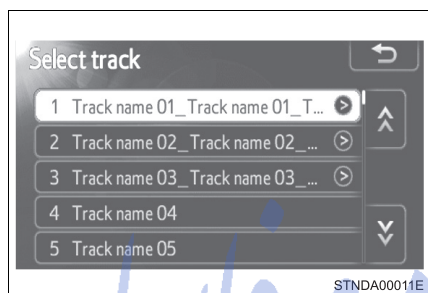

⬆ ⬇: To scroll to the next or previous page.

⏪: If ⏪ appears to the right of titles, the complete titles are too long for the display. Touch this button to scroll to the title.

Turn  to move the cursor box to select a desired item

from the list, and press  to play it. The track that is being played is highlighted.

#### ■ Using cellular phones

Interference may be heard through the audio system's speakers if a cellular phone is being used inside or close to the vehicle while the audio system is operating.

### 3-3. Using the “touch screen”

#### CAUTION

##### ■ Laser product

This product is a class 1 laser product.

- A laser beam leak may result in hazardous radiation exposure.
- Do not open the cover of the player or attempt to repair the unit yourself. Refer servicing to qualified personal.
- Laser power: No hazardous.

#### NOTICE

##### ■ To prevent battery discharge

Do not leave the audio system on longer than necessary when the engine is off.

##### ■ To avoid damaging the audio system

Take care not to spill drinks or other fluids on the audio system.

تلفن شبانه روزی: ۰۲۱-۸۸۶۲۰۸۵

FarmaSOS.com

### 3-3. Using the “touch screen” Using the radio

Touch “AM” or “FM” on the audio source selection screen.

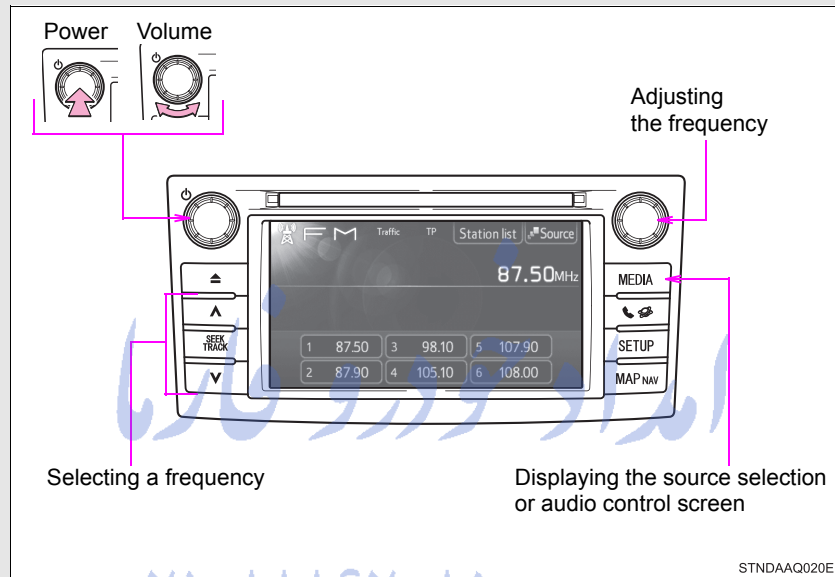

#### ■ Audio control screen

Pressing “MEDIA” displays the audio control screen from any screens of the selected source.

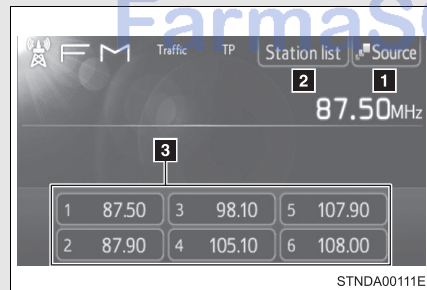

- 1 Audio source selection screen appears
- 2 Displaying the FM station list
- 3 Preset stations

### 3-3. Using the "touch screen"

#### Selecting a station

##### ■ Seek tuning

Press "∧" or "∨" on "SEEK/TRACK".

##### ■ Manual tuning

Turn  .

##### ■ Preset stations

Touch desired preset stations (1 to 6).

#### Using the FM station list

##### ■ Selecting a station from the FM station list

**STEP 1** Touch "Station list".

To return to the preset screen, touch "Presets".

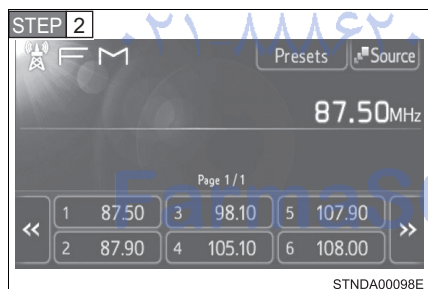

Touch desired station selector (1 to 6).  
تلفن شبانه روزی

Change the station list using 

or  .

The FM station list automatically searches for FM broadcasts by a band scan to generate a list of available radio stations.

### Setting station presets

**STEP 1** Search for desired stations by turning  or pressing "∧" or "∨" on "SEEK/TRACK".

**STEP 2** Touch and hold one of the preset stations (1 to 6) until you hear a beep.

### RDS (Radio Data System)

#### ■ Listening to stations of the same network

**FM Alternative frequency:** The station among those of the same network with strong reception is selected.

FM Alternative frequency on/off (→P. 326)

**Regional code change:** The station among those of the same network with strong reception and broadcasting the same program is selected.

Regional code change on/off (→P. 326)

FarmaSOS.com

### 3-3. Using the "touch screen"

#### ■ FM Traffic announcement

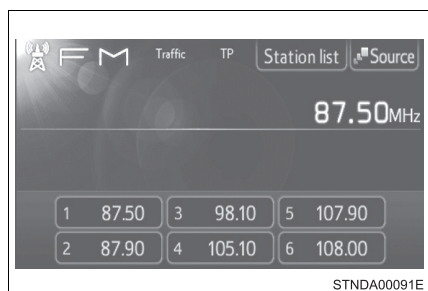

The system automatically switches to traffic information when a broadcast with a traffic information signal is received.

"TP" (Traffic program) will appear on the screen. The station returns to the previous one when the traffic information ends.

FM Traffic announcement on/off  
(→P. 326)

#### ■ Certification for the radio (for Italy)

IL PRODUTTORE Panasonic Corporation Automotive Systems Company 4261, Ikonobe-cho, Tsuzuki-ku, Yokohama, 224-8520, JAPAN DI QUESTO APPARECCHIO MODELLO 86140 0K130, 86140 0K120 DICHIARA CHE ESSO È CONFORME AL D.M.28.08.1995 Nr.548, OTTEMPERANDO ALLE PRESCRIZIONI DI CUI AL D.M.25.6.1985 (PARAGRAFO 3.ALL.A) ED AL D.M.27.8.1987 (PARAGRAFO 3.ALL.I).

تلفن شبانه روزی: ۰۲۱-۸۸۸۸۸۸۸۸

FarmaSOS.com

■ **EON (Enhanced Other Network) system (for traffic announcement function)**

If the RDS station (with EON data) you are listening to is not broadcasting a traffic information program and the audio system is in the TA (Traffic announcement) mode, the radio will be switched automatically to a station broadcasting a traffic information program in the EON AF list when traffic information begins.

■ **Reception sensitivity**

- Maintaining perfect radio reception at all times is difficult due to the continually changing position of the antenna, differences in signal strength and surrounding objects, such as trains, transmitters, etc.
- The radio antenna is mounted on the rear roof. The antenna can be removed from the base by turning it.

■ **Digital Audio Broadcast (DAB) radio**

The optional radio antenna and tuner are necessary for the use of Digital Audio Broadcast (DAB) radio.

تلفن شبانه روزی: ۰۲۱-۸۸۶۲۰۸۵

FarmaSOS.com

### 3-3. Using the “touch screen” Using the CD player

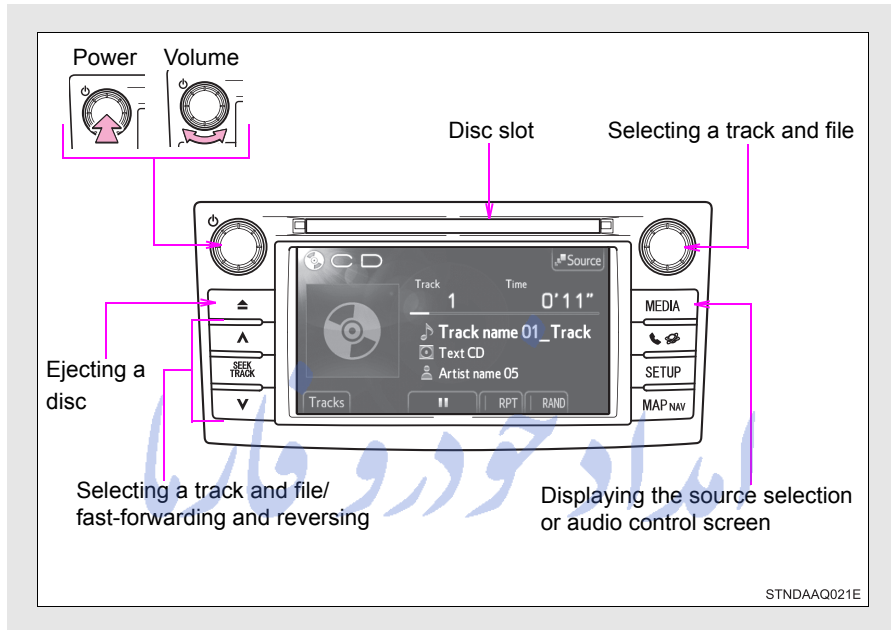

#### Loading a disc

Insert a disc into the disc slot.

#### Ejecting a disc

Press  and remove the disc.



### 3-3. Using the “touch screen”

## Playing an audio CD and MP3/WMA discs

Insert disc or touch “CD” on the audio source selection screen with a disc inserted.

#### ■ Audio control screen

Pressing “MEDIA” displays the audio control screen from any screens of the selected source.

#### Audio CD



- 1 Audio source selection screen appears
- 2 Displaying the track/file list
- 3 Pause  
Touch  to play
- 4 Repeat play
- 5 Random playback
- 6 Displaying the folder list

#### MP3/WMA disc



### 3-3. Using the "touch screen"

#### Selecting, fast-forwarding and reversing tracks (Audio CD)

##### ■ Selecting a track

Press "∧" or "∨" on "SEEK/TRACK" or turn  to select the desired track number.

To fast-forward or reverse, press and hold "∧" or "∨" on "SEEK/TRACK".

##### ■ Selecting a track from the track list

**STEP 1** Touch "Tracks" on the screen.

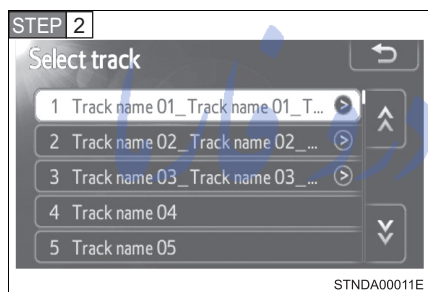

Touch the desired track number.

تلفن شبانه روزی: ۰۲۱-۸۸۸۶۲۰۸۵

FarmaSOS.com

### Selecting, fast-forwarding and reversing files (MP3/WMA disc)

#### ■ Selecting a file

Press "∧" or "∨" on "SEEK/TRACK" or turn  to select the desired file number.

To fast-forward or reverse, press and hold "∧" or "∨" on "SEEK/TRACK" until you hear a beep.

#### ■ Selecting a file from the file list

**STEP 1** Touch "Files" on the screen.

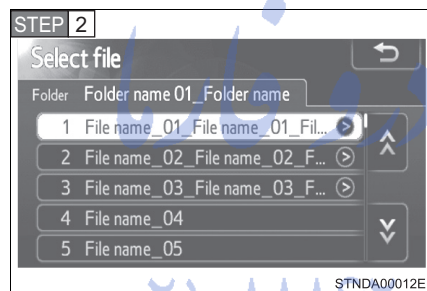

Touch the desired file number.

### 3-3. Using the "touch screen"

#### Selecting a folder (MP3/WMA disc)

STEP 1 Touch "Folders" on the screen.

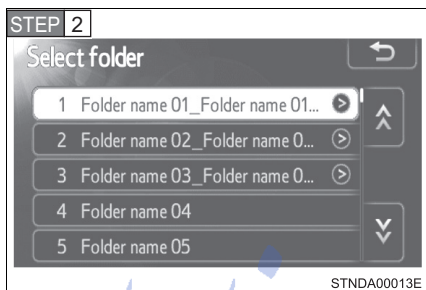

Touch the desired folder number.

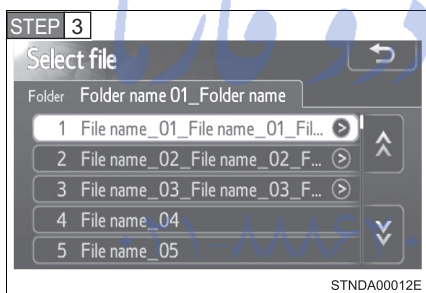

Touch the desired file number.

FarmaSOS.com

### Random playback

Each time **RAND** is touched, the mode changes in the following order:

#### Audio CD

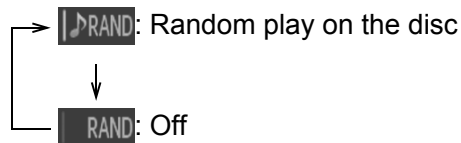

#### MP3/WMA disc

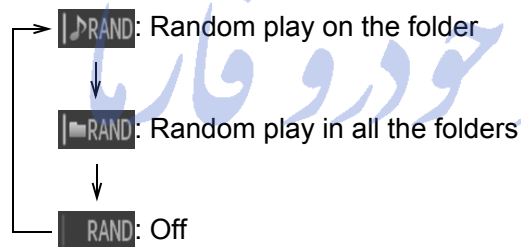

تلفن شبانه روزی: ۰۲۱-۸۸۶۲۰۸۵

FarmaSOS.com

### 3-3. Using the "touch screen"

#### Repeat play

Each time **RPT** is touched, the mode changes in the following order:

##### Audio CD

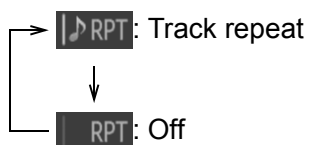

##### MP3/WMA disc

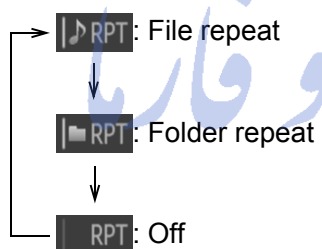

#### ■ Displaying the title and artist name

If a CD-TEXT disc is inserted, the title of the disc and track will be displayed.

FarmaSOS.com

### ■ Error messages

Refer to the following table and take the appropriate measures. If the problem is not rectified, take the vehicle to any authorized Toyota dealer or repairer, or another duly qualified and equipped professional.

Message	Cause	Correction procedures
Check DISC	<ul style="list-style-type: none"> <li>• The disc is dirty or damaged.</li> <li>• The disc is inserted upside down.</li> <li>• The disc is not playable with the player.</li> </ul>	<ul style="list-style-type: none"> <li>• Clean the disc.</li> <li>• Insert the disc correctly.</li> <li>• Confirm the disc is playable with the player.</li> </ul>
DISC error	There is a malfunction within the system.	Eject the disc.
No music files found	This indicates that no playable data is included in the disc.	Eject the disc.

### ■ Discs that can be used

Discs with the marks shown below can be used.

Playback may not be possible depending on recording format or disc features, or due to scratches, dirt or deterioration.



CDs with copy-protection features may not play correctly.

■ **CD player protection feature**

To protect the internal components, playback is automatically stopped when a problem is detected.

■ **If disc is left inside the CD player or in the ejected position for extended periods**

Disc may be damaged and may not play properly.

■ **Lens cleaners**

Do not use lens cleaners. Doing so may damage the CD player.

■ **MP3 and WMA files**

MP3 (MPEG Audio LAYER 3) is a standard audio compression format.

Files can be compressed to approximately 1/10 of their original size by using MP3 compression.

WMA (Windows Media Audio) is a Microsoft audio compression format.

This format compresses audio data to a size smaller than that of the MP3 format.

There is a limit to the MP3 and WMA file standards that can be used and to the media/formats on which the files are recorded.

- MP3 file compatibility
  - Compatible standards  
MP3 (MPEG1 LAYER3, MPEG2 LSF LAYER3)
  - Compatible sampling frequencies  
MPEG1 LAYER3: 32, 44.1, 48 (kHz)  
MPEG2 LSF LAYER3: 16, 22.05, 24 (kHz)
  - Compatible bit rates (compatible with VBR)  
MPEG1 LAYER3: 32—320 (kbps)  
MPEG2 LSF LAYER3: 8—160 (kbps)
  - Compatible channel modes: stereo, joint stereo, dual channel and monaural



- WMA file compatibility
  - Compatible standards  
WMA Ver. 7, 8, 9
  - Compatible sampling frequencies  
32, 44.1, 48 (kHz)
  - Compatible bit rates (only compatible with 2-channel playback)  
Ver. 7, 8: CBR 48—192 (kbps)  
Ver. 9: CBR 48—320 (kbps)

- Compatible media

Media that can be used for MP3 and WMA playback are CD-Rs and CD-RWs.

Playback in some instances may not be possible if the CD-R or CD-RW is not finalized. Playback may not be possible or the audio may jump if the disc is scratched or marked with fingerprints.

- Compatible disc formats

The following disc formats can be used.

- Disc formats: CD-ROM Mode 1 and Mode 2  
CD-ROM XA Mode 2, Form 1 and Form 2
- File formats: ISO9660 Level 1, Level 2, (Romeo, Joliet)  
UDF (2.01 or lower)

MP3 and WMA files written in any format other than those listed above may not play correctly, and their file names and folder names may not be displayed correctly.

Items related to standards and limitations are as follows.

- Maximum directory hierarchy: 8 levels (including the root)
- Maximum length of folder names/file names: 32 characters
- Maximum number of folders: 192 (including the root)
- Maximum number of files per disc: 255

### 3-3. Using the “touch screen”

- File names

The only files that can be recognized as MP3/WMA and played are those with the extension .mp3 or .wma.

- Discs containing multi-session recordings

As the audio system is compatible with multi-sessions, it is possible to play discs that contain MP3 and WMA files. However, only the first session can be played.

- ID3 and WMA tags

ID3 tags can be added to MP3 files, making it possible to record the track title, artist name, etc.

The system is compatible with ID3 Ver. 1.0, 1.1, and Ver. 2.2, 2.3 ID3 tags. (The number of characters is based on ID3 Ver. 1.0 and 1.1.)

WMA tags can be added to WMA files, making it possible to record the track title and artist name in the same way as with ID3 tags.

- MP3 and WMA playback

When a disc containing MP3 or WMA files is inserted, all files on the disc are first checked. Once the file check is finished, the first MP3 or WMA file is played. To make the file check finish more quickly, we recommend you do not write in any files other than MP3 or WMA files or create any unnecessary folders.

Discs that contain a mixture of music data and MP3 or WMA format data cannot be played.

FarmaSOS.com

- Extensions

If the file extensions .mp3 and .wma are used for files other than MP3 and WMA files, they may be mistakenly recognized and played as MP3 and WMA files. This may result in large amounts of interference and damage to the speakers.

- Playback

- To play MP3 files with steady sound quality, we recommend a fixed bit rate of at least 128 kbps and a sampling frequency of 44.1 kHz.
- CD-R or CD-RW playback may not be possible in some instances, depending on the characteristics of the disc.
- There is a wide variety of freeware and other encoding software for MP3 and WMA files on the market, and depending on the status of the encoding and the file format, poor sound quality or noise at the start of playback may result. In some cases, playback may not be possible at all.
- When files other than MP3 or WMA files are recorded on a disc, it may take more time to recognize the disc and in some cases, playback may not be possible at all.
- Microsoft, Windows, and Windows Media are the registered trademarks of Microsoft Corporation in the U.S.A. and other countries

تلفن شبانه روزی: ۰۲۱-۸۸۶۲۰۸۵

FarmaSOS.com

 NOTICE

■ **Discs and adapters that cannot be used**

Do not use the following types of discs, 8 cm (3 in.) disc adapters or Dual Discs.  
Doing so may damage the player and/or disc insert/eject function.

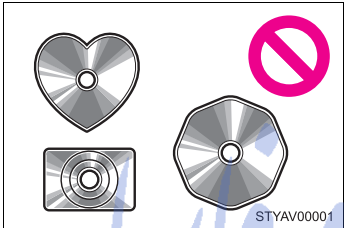
 STYAV00001

- Discs that have a diameter that is not 12 cm (4.7 in.).

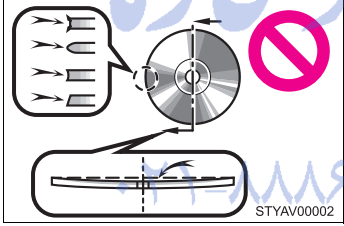
 STYAV00002

- Low-quality or deformed discs.

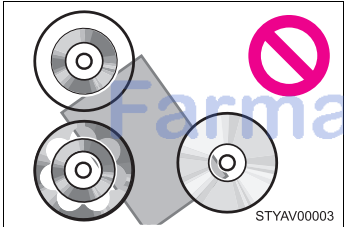
 STYAV00003

- Discs with a transparent or translucent recording area.

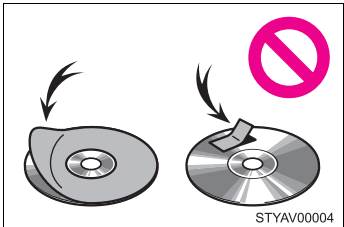
 STYAV00004

- Discs that have tape, stickers or CD-R labels attached to them, or that have had the label peeled off.

 NOTICE

■ **Player precautions**

Failure to follow the precautions below may result in damage to the discs or the player itself.

- Do not insert anything other than discs into the disc slot.
- Do not apply oil to the player.
- Store discs away from direct sunlight.
- Never try to disassemble any part of the player.

امداد خودرو فارما

تلفن شبانه روزی: ۰۲۱-۸۸۶۲۰۸۵

FarmaSOS.com

### 3-3. Using the “touch screen” Listening to an iPod

Connecting an iPod enables you to enjoy music from the vehicle speakers.

Touch “iPod” on the audio source selection screen.

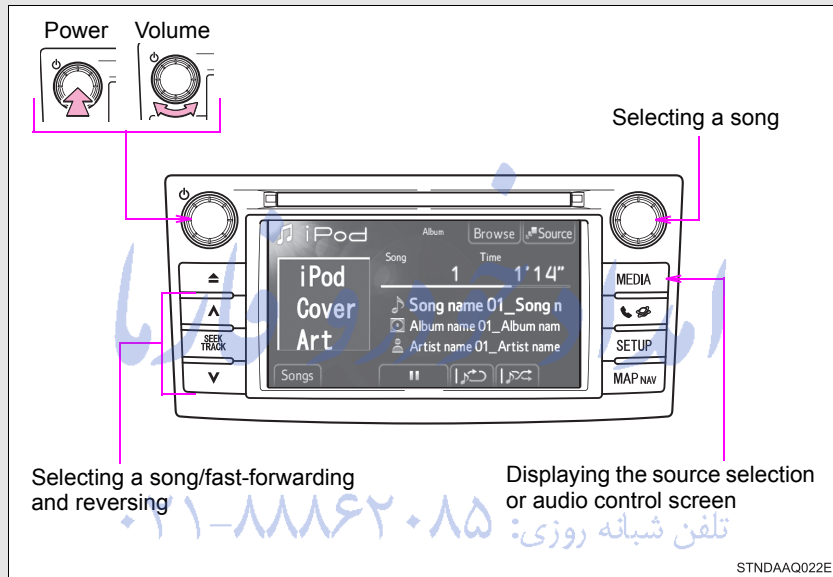

FarmaSOS.com

### ■ Audio control screen

Pressing "MEDIA" displays the audio control screen from any screens of the selected source.



- 1 Audio source selection screen appears
- 2 Selecting the play mode
- 3 Displaying the song list
- 4 Pause  
Touch  to playback
- 5 Repeat play
- 6 Shuffle play

تلفن شبانه روزی: ۰۲۱-۸۸۶۲۰۸۵

FarmaSOS.com

### 3-3. Using the “touch screen”

#### Connecting an iPod

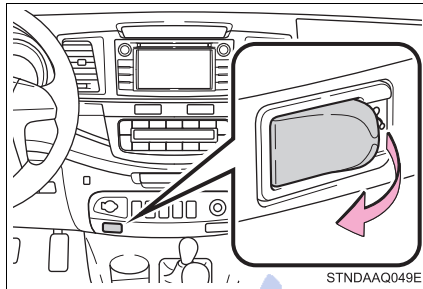

Open the cover and connect the iPod.

Turn on the power of the iPod if it is not turned on.

#### Playing an iPod

##### ■ Play/Pause

Touch  or  to Play/Pause.

##### ■ Selecting a play mode

**STEP 1** Touch “Browse” on the screen.



Select the desired play mode by touching the “Playlists”, “Artists”, “Albums”, “Songs”, “Podcasts”, “Audio books”, “Genres” or “Composers” tabs.



### Selecting, fast-forwarding and reversing songs

#### ■ Selecting one song at a time

Press "∧" or "∨" on "SEEK/TRACK" or turn  to select the desired song.

To fast-forward or reverse, press and hold "∧" or "∨" on "SEEK/TRACK" until you hear a beep.

#### ■ Selecting a song from the list

**STEP 1** Touch "Songs" on the screen.



Touch the desired song.

### 3-3. Using the "touch screen"

#### Shuffle play

Each time  is touched, the mode changes in the following order:

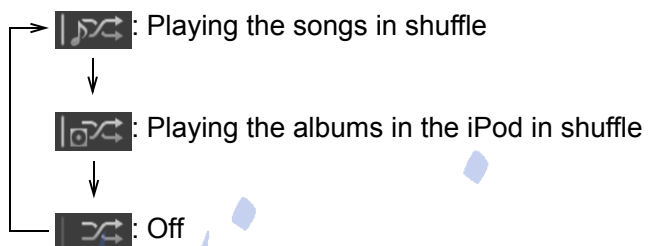

When a large number of songs is stored in an iPod, shuffle selection may take time.

#### Repeat play

Each time  is touched, the mode changes in the following order:

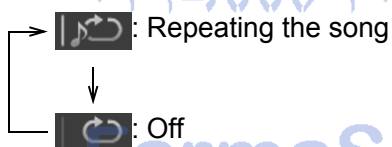

### ■ About iPod



- “Made for iPod” and “Made for iPhone” mean that an electronic accessory has been designed to connect specifically to iPod, or iPhone, respectively, and has been certified by the developer to meet Apple performance standards.
  - Apple is not responsible for the operation of this device or its compliance with safety and regulatory standards. Please note that the use of this accessory with iPod or iPhone may affect wireless performance.
  - iPhone, iPod, iPod classic, iPod nano and iPod touch are trademarks of Apple Inc., registered in the U.S. and other countries.
- **iPod cover art**
- Depending on the iPod and songs in the iPod, iPod cover art may be displayed.
  - This function can be changed to “On” or “Off”. (→P. 320)
  - It may take time to display iPod cover art, and the iPod may not be operated while the cover art display is in process.
  - Only iPod cover art that is saved in a JPEG format can be displayed.

■ **iPod functions**

- When an iPod is connected and the audio source is changed to iPod mode, the iPod will resume play from the same point in which it was last used.
- Depending on the iPod that is connected to the system, certain functions may not be available. If a function is unavailable due to a malfunction (as opposed to a system specification), disconnecting the device and reconnecting it once again may resolve the problem.
- While connected to the system, the iPod cannot be operated with its own controls. It is necessary to use the controls of the vehicle's audio system instead.
- When the battery level of an iPod is very low, the iPod may not operate. If so, charge the iPod before use.
- Supported models (→P. 358)

■ **iPod problems**

To resolve most problems encountered when using your iPod, disconnect your iPod from the vehicle iPod connection and reset it. For instructions on how to reset your iPod, refer to your iPod Owner's Manual.

تلفن شبانه روزی: ۰۲۱-۸۸۶۲۰۸۵

FarmaSOS.com

■ **Error messages**

“Connection error.”: This indicates a problem in the iPod or its connection.

“There are no songs available for playback.”:

This indicates that there is no music data in the iPod.

“No items available.”: This indicates that some available songs are not found in a selected playlist.

“Please check the iPod firmware version.”:

This indicates that the software version is not compatible.

Please check the compatible models. (→P. 358)

“iPod authorization failed.”:

This indicates that it failed to authorize the iPod.  
Please check your iPod.

تلفن شبانه روزی: ۰۲۱-۸۸۶۲۰۸۵

FarmaSOS.com

### 3-3. Using the “touch screen”

#### ■ Compatible models

The following iPod®, iPod nano®, iPod classic®, iPod touch® and iPhone® devices can be used with this system.

##### ● Made for

- iPod touch (4th generation)
- iPod touch (3rd generation)
- iPod touch (2nd generation)
- iPod touch (1st generation)
- iPod classic
- iPod with video
- iPod nano (6th generation)
- iPod nano (5th generation)
- iPod nano (4th generation)
- iPod nano (3rd generation)
- iPod nano (2nd generation)
- iPod nano (1st generation)
- iPhone 4
- iPhone 3GS
- iPhone 3G
- iPhone

Depending on differences between models or software versions etc., some models might be incompatible with this system.

FarmaSOS.com

 CAUTION

■ **While driving**

Do not connect an iPod or operate the controls.

 NOTICE

■ **To prevent damage to the iPod or its terminal**

- Do not leave the iPod in the vehicle. The temperature inside the vehicle may become high, resulting in damage to the iPod.
- Do not push down on or apply unnecessary pressure to the iPod while it is connected.
- Do not insert foreign objects into the port.

تلفن شبانه روزی: ۰۲۱-۸۸۶۲۰۸۵

FarmaSOS.com

### 3-3. Using the “touch screen” Listening to a USB memory

Connecting a USB memory enables you to enjoy music from the vehicle speakers.

Touch “USB” on the audio source selection screen.

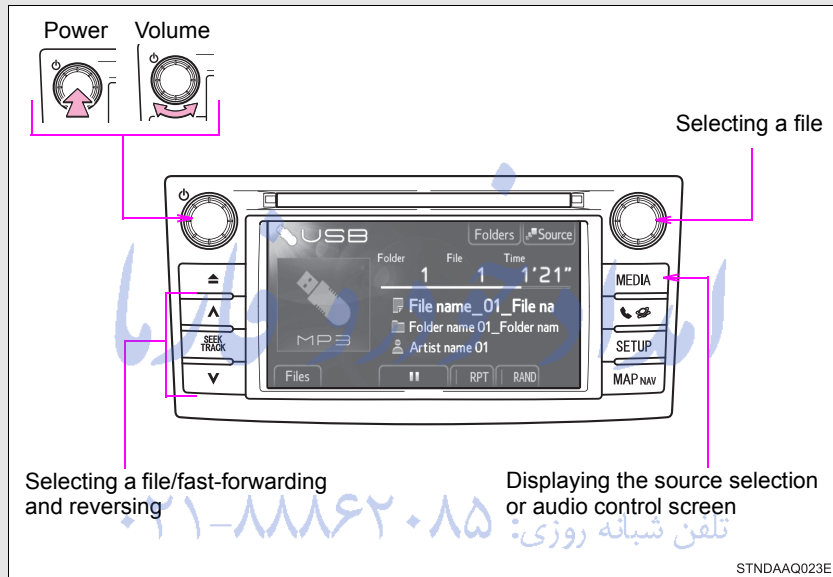

FarmaSOS.com



■ **Audio control screen**

Pressing "MEDIA" displays the audio control screen from any screens of the selected source.



- 1 Audio source selection screen appears
- 2 Displaying the folder list
- 3 Displaying the file list
- 4 Pause  
Touch ▶ to playback
- 5 Repeat play
- 6 Random playback

تلفن شبانه روزی: ۰۲۱-۸۸۶۲۰۸۵

FarmaSOS.com

### 3-3. Using the "touch screen"

#### Connecting a USB memory

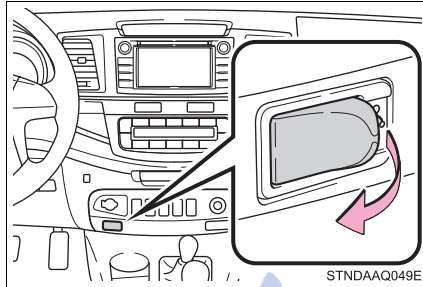

Open the cover and connect the USB memory.

Turn on the power of the USB memory if it is not turned on.

#### Selecting, fast-forwarding and reversing files

##### ■ Selecting one file at time

Press "∧" or "∨" on "SEEK/TRACK" or turn  to select the desired file.

To fast-forward or reverse, press and hold "∧" or "∨" on "SEEK/TRACK" until you hear a beep.

##### ■ Selecting a file from the list

**STEP 1** Touch "Files" on the screen.

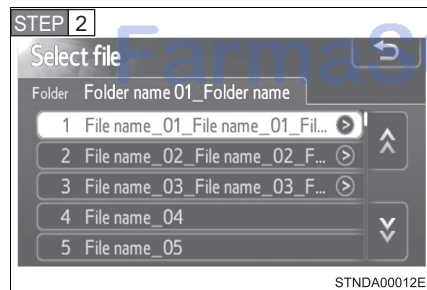

Touch the desired file number.

### Selecting a folder

STEP 1 Touch "Folders" on the screen.

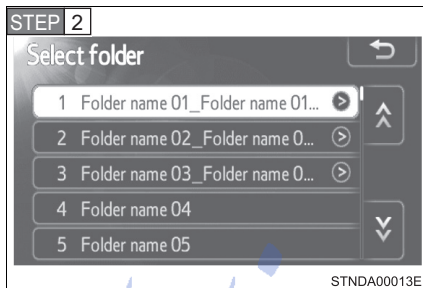

Touch the desired folder number.

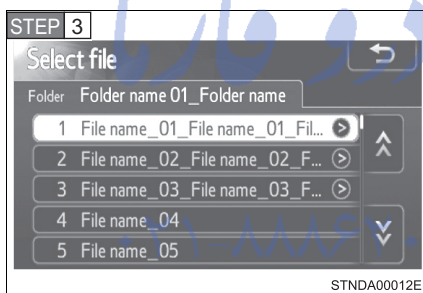

Touch the desired file number.

FarmaSOS.com

### 3-3. Using the "touch screen"

#### Random playback

Each time **RAND** is touched, the mode changes in the following order:

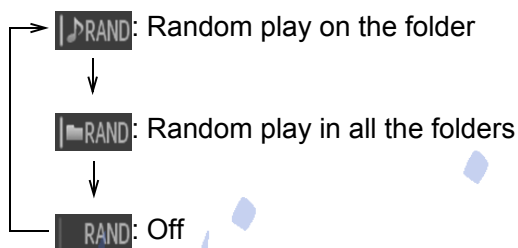

#### Repeat play

Each time **RPT** is touched, the mode changes in the following order:



#### ■ USB memory functions

- Depending on the USB memory that is connected to the system, the device itself may not be operable and certain functions may not be available. If the device is inoperable or a function is unavailable due to a malfunction (as opposed to a system specification), disconnecting the device and reconnecting it once again may resolve the problem.
- If the USB memory still does not begin operation after being disconnected and reconnected, format the memory.

#### ■ Error messages for USB memory

“Connection error.”: This indicates a problem in the USB memory or its connection.

“There are no files available for playback.”:

This indicates that no MP3/WMA files are included in the USB memory.

#### ■ USB memory

- Compatible devices

USB memory that can be used for MP3 and WMA playback.

- Compatible device formats

The following device formats can be used:

- USB communication formats: USB2.0 FS (12 Mbps)
  - File formats: FAT16/32 (Windows)
  - Correspondence class: Mass storage class
- MP3 and WMA files written in any format other than those listed above may not play correctly, and their file names and folder names may not be displayed correctly.

Items related to standards and limitations are as follows:

- Maximum directory hierarchy: 8 levels
- Maximum number of folders in a device: 3000 (including the root)
- Maximum number of files in a device: 9999
- Maximum number of files per folder: 255

### 3-3. Using the “touch screen”

- MP3 and WMA files

MP3 (MPEG Audio LAYER 3) is a standard audio compression format.

Files can be compressed to approximately 1/10 of their original size using MP3 compression.

WMA (Windows Media Audio) is a Microsoft audio compression format. This format compresses audio data to a size smaller than that of the MP3 format.

There is a limit to the MP3 and WMA file standards that can be used and to the media/formats on which the files are recorded.

- MP3 file compatibility

- Compatible standards

MP3 (MPEG1 AUDIO LAYERII, III, MPEG2 AUDIO LAYERII, III, MPEG2.5)

- Compatible sampling frequencies

MPEG1 AUDIO LAYERII, III: 32, 44.1, 48 (kHz)

MPEG2 AUDIO LAYERII, III: 16, 22.05, 24 (kHz)

- Compatible bit rates (compatible with VBR)

MPEG1 AUDIO LAYERII, III: 32-320 (kbps)

MPEG2 AUDIO LAYERII, III: 8-160 (kbps)

- Compatible channel modes: stereo, joint stereo, dual channel and monaural

- WMA file compatibility

- Compatible standards

WMA Ver. 7, 8, 9

- Compatible sampling frequencies

HIGH PROFILE 32, 44.1, 48 (kHz)

- Compatible bit rates

HIGH PROFILE 48-320 (kbps, VBR)

- File names

The only files that can be recognized as MP3/WMA and played are those with the extension .mp3 or .wma.

- ID3 and WMA tags

ID3 tags can be added to MP3 files, making it possible to record the track title, artist name, etc.

The system is compatible with ID3 Ver. 1.0, 1.1, and Ver. 2.2, 2.3, 2.4 ID3 tags. (The number of characters is based on ID3 Ver. 1.0 and 1.1.)

WMA tags can be added to WMA files, making it possible to record the track title and artist name in the same way as with ID3 tags.

- MP3 and WMA playback

- When a device containing MP3 or WMA files is connected, all files in the USB memory device are checked. Once the file check is finished, the first MP3 or WMA file is played. To make the file check finish more quickly, we recommend that you do not include any files other than MP3 or WMA files or create any unnecessary folders.
- When the USB device is connected and the audio source is changed to USB memory mode, the USB device will start playing the first file in the first folder. If the same device is removed and reinserted (and the contents have not been changed), the USB device will resume play from the same point in which it was last used.

- Extensions

If the file extensions .mp3 and .wma are used for files other than MP3 and WMA files, they will be skipped (not played).

### 3-3. Using the “touch screen”

- Playback

- To play MP3 files with steady sound quality, we recommend a fixed bit rate of at least 128 kbps and a sampling frequency of 44.1 kHz.
- There is a wide variety of freeware and other encoding software for MP3 and WMA files on the market, and depending on the status of the encoding and the file format, poor sound quality or noise at the start of playback may result. In some cases, playback may not be possible at all.
- Microsoft, Windows, and Windows Media are the registered trademarks of Microsoft Corporation in the U.S.A. and other countries.

#### CAUTION

##### ■ While driving

Do not connect a USB memory or operate the controls.

#### NOTICE

##### ■ To prevent damage to the USB memory or its terminal

- Do not leave USB memory in the vehicle. The temperature inside the vehicle may become high, resulting in damage to the USB memory.
- Do not push down on or apply unnecessary pressure to the USB memory while it is connected.
- Do not insert foreign objects into the port.



### 3-3. Using the “touch screen” Using the AUX port

This port can be used to connect a portable audio device and listen to it through the vehicle’s speakers.

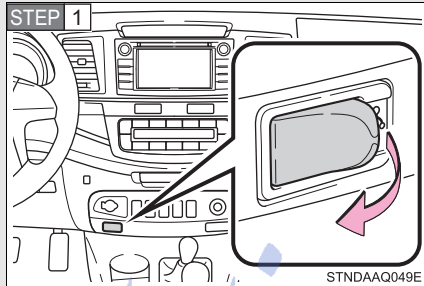

Open the cover and connect the portable audio device.

**STEP 2** Touch “AUX” on the audio source selection screen.

#### ■ Operating portable audio devices connected to the audio system

The volume can be adjusted using the vehicle’s audio controls. All other adjustments must be made on the portable audio device itself.

#### ■ When using a portable audio device connected to the power outlet

Noise may occur during playback. Use the power source of the portable audio device.

3

Interior features

FarmaSOS.com

### 3-3. Using the “touch screen” Listening to Bluetooth® audio

The Bluetooth® audio system enables users to enjoy music played on a portable player from the vehicle speaker via wireless communication. This audio system supports Bluetooth®, a wireless data system capable of playing portable audio music without cables. If your portable player does not support Bluetooth®, the Bluetooth® audio system will not function.

Touch “BT” on the audio source selection screen.

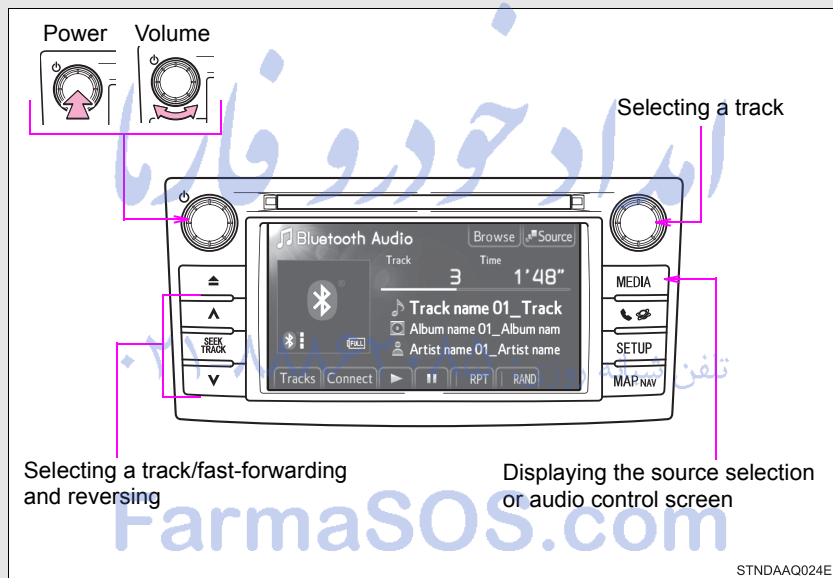

■ **Audio control screen**

Pressing "MEDIA" displays the audio control screen from any screens of the selected source.



- 1 Audio source selection screen appears
- 2 Displaying the album list
- 3 Displaying the track list
- 4 Connecting a Bluetooth® audio player
- 5 Playback
- 6 Pause
- 7 Repeat play
- 8 Random playback

تلفن شبانه روزی: ۰۲۱-۸۸۶۲۰۸۵

FarmaSOS.com

### 3-3. Using the "touch screen"





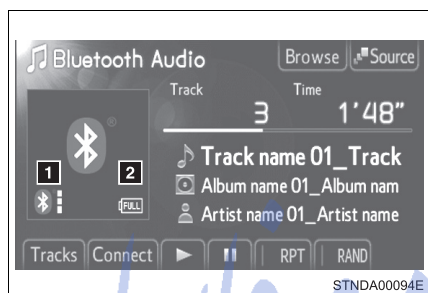

#### Status display

You can check such indicators as signal strength and battery charge on the screen.



1 Connection status

2 Battery charge

Indicators	Conditions
Connection status	Good ←————→ Not connected   
Battery charge	Full ←————→ Empty   

FarmaSOS.com

### Registering a Bluetooth® audio player

To use the Bluetooth® audio system, you need to register your portable audio player into the system. Once registered, you can enjoy your music on the vehicle’s audio system.

You can register up to 5 devices in the system.

**STEP 1** Display the “Bluetooth\* Audio” screen.

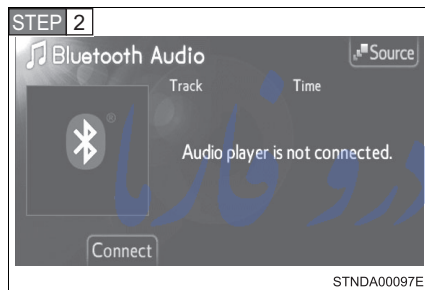

Touch “Connect”.

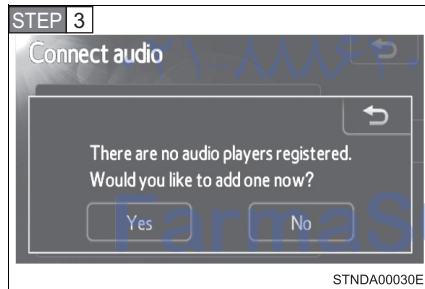

Touch “Yes”.

\*: Bluetooth is a registered trademark of Bluetooth SIG. Inc.

### 3-3. Using the “touch screen”

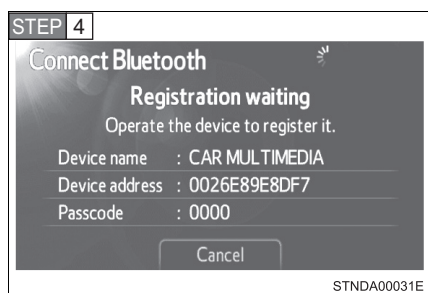

Input the passcode displayed on the screen into your portable audio player.

For the operation of the portable audio player, see the manual that comes with your portable audio player.

Passcodes are not required for SSP (Secure Simple Pairing) compatible Bluetooth® devices. Depending on the device, you may need to select “Yes” to register, or “No” to cancel on your Bluetooth® device.

If you want to cancel it, select “Cancel”.

If a completion message is displayed, registration is complete.

If an error message is displayed, follow the guidance on the screen to try again.

FarmaSOS.com

**Selecting the Bluetooth® audio player**

If multiple Bluetooth® devices are registered, follow the procedure below to select the Bluetooth® device to be used. You may only use one device at a time.

**STEP 1** Display the “Bluetooth\* Audio” screen.

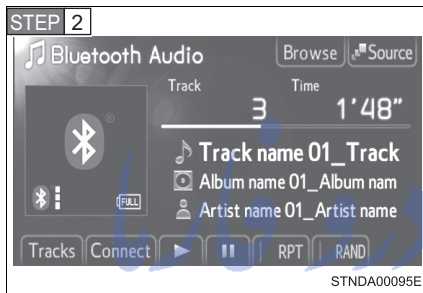

Touch “Connect”.

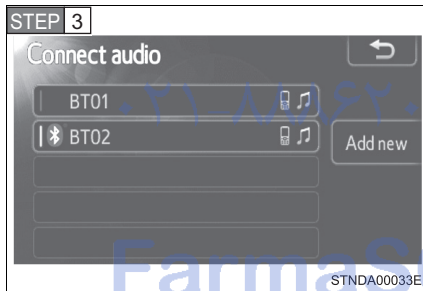

Touch the device to connect.

“Add new”: Registering a Bluetooth® device. (→P. 429)

The selection indicator is displayed on left side of the selected device name.

The Bluetooth® mark is displayed when you connected the device.

\*: Bluetooth is a registered trademark of Bluetooth SIG. Inc.

### Connecting the Bluetooth® audio player

There are two connection methods available.

■ **When the connection method is set to “From vehicle”**

When the portable audio player is on standby for the connection, it will be automatically connected whenever the engine switch is in either the “ACC” or “ON” position.

■ **When the connection method is set to “From audio player”**

Operate the portable player and connect it to the Bluetooth® audio system.

**STEP 1** Display the “Bluetooth\* Audio” screen.

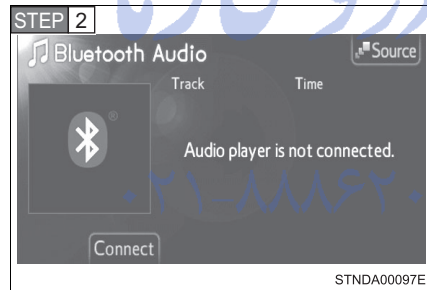

Touch “Connect”.

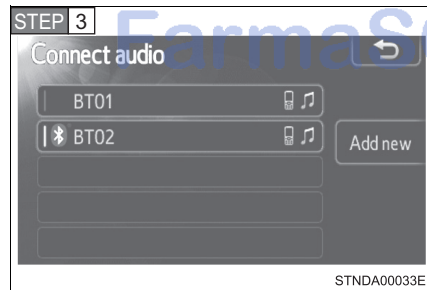

Touch the device to connect.

A message is shown if connection has been successful.

If connection fails, a message will be displayed and connection will be re-attempted.

\*: Bluetooth is a registered trademark of Bluetooth SIG. Inc.



### Playing Bluetooth® audio

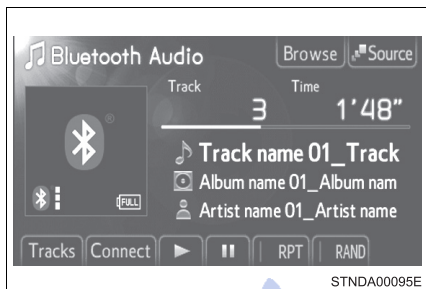

Touch  or  to play/pause.

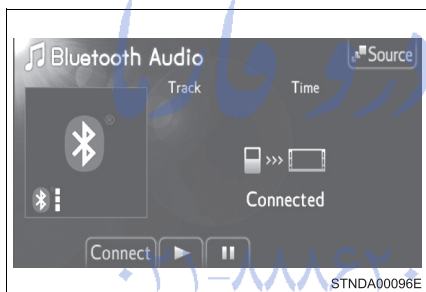

Some titles and controls may not be displayed depending on the type of portable audio player.

3

Interior features

FarmaSOS.com

### 3-3. Using the "touch screen"

#### Selecting a track

##### ■ Selecting a track

Press "∧" or "∨" on "SEEK/TRACK" or turn  to select the desired track number.

To fast-forward or rewind, press and hold "∧" or "∨" on "SEEK/TRACK" until you hear a beep.

##### ■ Selecting a track from the list

**STEP 1** Touch "Tracks" on the screen.

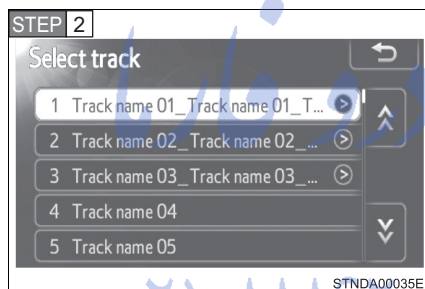

Touch the desired track.

تلفن شبانه روزی: ۰۲۱-۸۸۸۲۰۸۵

FarmaSOS.com

### Selecting an album

STEP 1 Touch "Browse" on the screen.

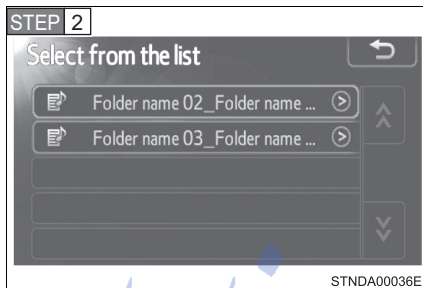

Touch the desired album.

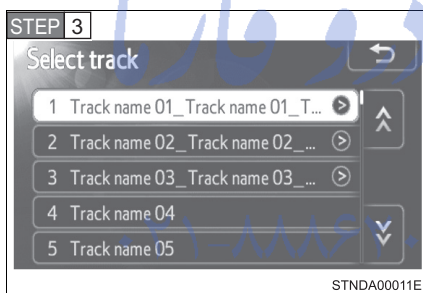

Touch the desired track.

FarmaSOS.com

### 3-3. Using the "touch screen"

#### Random playback

Each time **RAND** is touched, the mode changes in the following order:

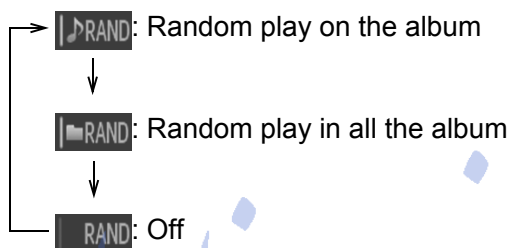

#### Repeat play

Each time **RPT** is touched, the mode changes in the following order:

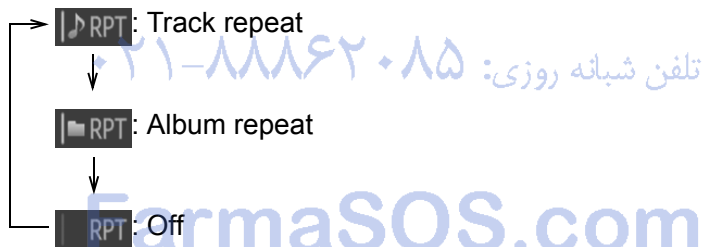

#### ■ When using the Bluetooth® audio system

- In the following conditions, the system may not function.
  - If the portable audio player is turned off
  - If the portable audio player is not connected
  - If the portable audio player's battery is low
- There may be a delay if phone connection is carried out during Bluetooth® audio play.
- Depending on the type of portable audio player that is connected to the system, operation may differ slightly and certain functions may not be available.

#### ■ Bluetooth® antenna

The antenna is built into the display. If the portable audio player is behind the seat or in the glove box or console box, or is touching or covered by metal objects, connection status may deteriorate.

#### ■ Battery charge/signal status

This display may not correspond exactly with the portable audio player, and this system does not have a charging function.

#### ■ About Bluetooth®



Bluetooth is a registered trademark of Bluetooth SIG, Inc.

The Bluetooth word mark and logos are owned by the Bluetooth SIG, Inc. and any use of such marks by Panasonic Corporation is under license. Other trademarks and trade names are those of their respective owners.

#### ■ Compatible models

Portable audio players must correspond to the specifications.

- Bluetooth® specifications:

- Ver. 1.1, or higher (Recommended: Ver. 2.1 + EDR or higher)

- Profiles:

- A2DP (Advanced Audio Distribution Profile) Ver. 1.0, or higher (Recommended: Ver. 1.2 or higher)

- This is a profile to transmit stereo audio or high quality sounds to the headphone.

- AVRCP (Audio/Video Remote Control Profile) Ver. 1.0 or higher (Recommended: Ver. 1.4 or higher)

- This is a profile to remote control the A/V equipment.

However, please note that some functions may be limited depending on the type of portable audio player.

#### ■ Certification

→P. 393

#### ■ Reconnecting the portable audio player

If the portable audio player is disconnected due to a poor reception when the engine switch is in the "ACC" or "ON" position, the system automatically reconnects the portable audio player when possible.

If you have switched off the portable audio player yourself, follow the instructions below to reconnect:

- Select the portable audio player again
- Enter the portable audio player

#### ■ When you release your car

Be sure to initialize your data. (→P. 321)

 CAUTION

■ **While driving**

Do not use the portable audio player or connect the Bluetooth® system.

 NOTICE

■ **When leaving the vehicle**

Do not leave your portable audio player in the vehicle. The inside of the vehicle may become hot, causing damage to the portable audio player.

امداد خودرو فارما

تلفن شبانه روزی: ۰۲۱-۸۸۶۲۰۸۵

FarmaSOS.com

### 3-3. Using the “touch screen”

## Using the steering wheel audio switches

Some audio features can be controlled using the switches on the steering wheel.

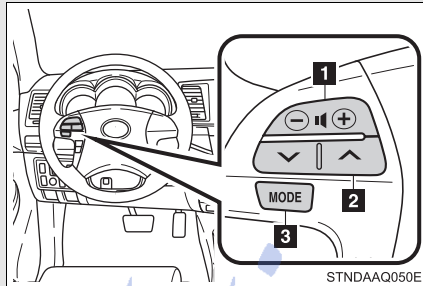

**1** Volume

**2** Radio mode: Selects radio stations

CD mode:

Selects tracks/files and folders (MP3/WMA)

iPod mode: Select songs

USB memory mode:

Selects files and folders

Bluetooth® audio mode:

Selects tracks and albums

**3** Turns the power on, selects audio source

FarmaSOS.com



#### Turning on the power

Press "MODE" when the audio system is turned off.

#### Changing the audio source

Press "MODE" when the audio system is turned on. The audio source changes as follows each time "MODE" is pressed. If no discs are inserted in the player, or if the external device is not connected, that mode will be skipped.

FM→CD player→iPod or USB memory→Bluetooth® audio→AUX→AM

#### Adjusting the volume

Press "+" on  to increase the volume and "-" to decrease the volume.

Hold the switch in that position to continue increasing or decreasing the volume.

#### Silencing a sound

Press and hold the "MODE".

To cancel, press and hold the "MODE".

### 3-3. Using the "touch screen"

#### Selecting a radio station

**STEP 1** Press "MODE" to select the radio mode.

**STEP 2** Press "∧" or "∨" on  to select a radio station.

To seek stations, press and hold the switch until you hear a beep.

#### Selecting a track/file or song

**STEP 1** Press "MODE" to select the CD, Bluetooth® audio, iPod, USB memory mode.

**STEP 2** Press "∧" or "∨" on  to select the desired track/file or song.

#### Selecting a folder

**STEP 1** Press "MODE" to select the CD (only when MP3/WMA disc is in use) or USB memory mode.

**STEP 2** Press and hold "∧" or "∨" on  until you hear a beep.

#### Selecting an album

**STEP 1** Press "MODE" to select the Bluetooth® audio mode.

**STEP 2** Press and hold "∧" or "∨" on  until you hear a beep.

#### CAUTION

##### ■ To reduce the risk of an accident

Exercise care when operating the audio switches on the steering wheel.

### 3-3. Using the “touch screen” Hands-free system (for cellular phone)

The hands-free system is a function that allows you to use your cellular phone without touching it.

This system supports Bluetooth®. Bluetooth® is a wireless data system that allows the cellular phone to wirelessly connect to the hands-free system and make/receive calls.

#### ■ Telephone switch

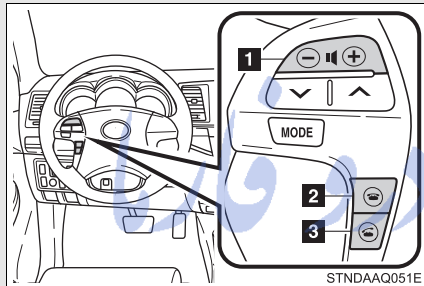

- 1** Volume switch
    - Increase the volume
    - Decrease the volume
  - 2** On hook switch
    - End call
    - Refuse call
  - 3** Off hook switch
    - Sending
    - Receiving
    - “Telephone” screen display
- تلفن شبانه روزی: ۰۲۱-۸۸۶۲۰۸۵

### 3-3. Using the "touch screen"

#### ■ Microphone

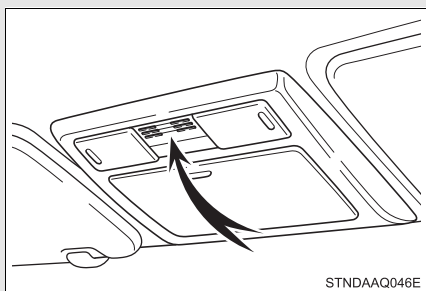

You can use the microphone when talking on the phone.

The person you are speaking to can be heard from the front speakers.

To use the hands-free system, you must register your Bluetooth® phone in the system. (→P. 396)

تلفن شبانه روزی: ۰۲۱-۸۸۸۶۲۰۸۵







FarmaSOS.com

**Status display**

You can check indicators such as signal strength and battery charge on the “Telephone” screen.



- 1** Connection status
- 2** Battery charge
- 3** Call area
- 4** Signal strength

Indicators	Conditions
Connection status	Good <span style="margin-left: 100px;">←→</span> Not connected  <span style="margin-left: 100px;"></span>
Battery charge	Full <span style="margin-left: 100px;">←→</span> Empty  <span style="margin-left: 100px;"></span>
Call area	“Rm”: Roaming area
Signal strength	Excellent <span style="margin-left: 100px;">←→</span> Poor  <span style="margin-left: 100px;"></span>

---

■ **When using the hands-free system**

- The audio system is muted when making a call.
- If both parties speak at the same time, it may be difficult to hear.
- If the received call volume is overly loud, an echo may be heard.  
If the Bluetooth® phone is too close to the system, quality of the sound may deteriorate and connecting condition may go down.
- In the following circumstances, it may be difficult to hear the other party:
  - When driving on unpaved roads
  - When driving at high speeds
  - If a window is open
  - If the air conditioning is blowing directly on the microphone
  - There is an effect from the network of the cellular phone

■ **Conditions under which the system will not operate**

- If using a cellular phone that does not support Bluetooth®
- If the cellular phone is turned off
- If you are outside service range
- If the cellular phone is not connected
- If the cellular phone's battery is low
- When outgoing is controlled, due to heavy traffic on telephone lines, etc.
- When the cellular phone itself cannot be used
- When transferring the phonebook data from the cellular phone

#### ■ Bluetooth® antenna

The antenna is built into the display. If the cellular phone is behind the seat or in the console box, or touching or covered by metal objects, connection status may deteriorate.

#### ■ Battery charge/Signal status

- This display may not correspond exactly with the cellular phone itself.
- This system does not have a charging function.
- The Bluetooth® phone battery will burn quickly when it is connected to Bluetooth®.

#### ■ When using Bluetooth® audio and hands-free system at the same time

The following problems may occur.

- The Bluetooth® connection may be cut.
- Noise may be heard on the Bluetooth® audio playback.

#### ■ About the phonebook in this system

The following data is stored for every registered phone. When another phone is connecting, you cannot read the registered data.

- Phonebook data
- Call history data
- Speed dial

When you delete the phone, the above-mentioned data is also deleted.

#### ■ When you release your car

Be sure to initialize your data. (→P. 321)

#### ■ About Bluetooth®



Bluetooth is a registered trademark of Bluetooth SIG, Inc.

The Bluetooth word mark and logos are owned by the Bluetooth SIG, Inc. and any use of such marks by Panasonic Corporation is under license. Other trademarks and trade names are those of their respective owners.

#### ■ Compatible models

This system supports the following service.

- Bluetooth® Specification:  
Ver. 1.1 or higher (Recommended: Ver. 2.1+EDR or higher)
- Profiles:
  - HFP (Hands Free Profile) Ver. 1.0 or higher (Recommended: Ver. 1.5 or higher)  
This is a profile to allow hands-free phone calls using the cellular phone or head sets. It has an outgoing and incoming call function.
  - OPP (Object Push Profile) Ver. 1.1 or higher  
This is a profile to exchange phonebook data. When the Bluetooth® phone has PBAP and OPP, OPP cannot be used.
  - PBAP (Phone Book Access Profile) Ver. 1.0 or higher  
This is a profile to transfer phonebook data.

If your cellular phone does not support HFP, you cannot enter the Bluetooth® phone. You need to take OPP or PBAP service individually.



■ Certification



**Declaration of Conformity (DoC)**

Hereby, Panasonic Corporation, declares that this Bluetooth Module ASSY (YEAP01A112) is in compliance with the essential requirements and other relevant provisions of Directive 1999/5/EC.

The latest original "DECLARATION of CONFORMITY" (DoC) is available at the address stated.

[DoC Website address] <http://www.ptc.panasonic.de/>

(To see the DoC for the product's component, input the product search number: YEAP01A112)

امداد خودرو فارما

تلفن شبانه روزی: ۰۲۱-۸۸۶۲۰۸۵

FarmaSOS.com

### 3-3. Using the “touch screen”

#### CAUTION

##### ■ While driving

Do not use the cellular phone or connect the Bluetooth® system.

#### NOTICE

##### ■ When leaving the vehicle

Do not leave your cellular phone in the vehicle. The inside of the vehicle may become hot, causing damage to the phone.

امداد خودرو فارما

تلفن شبانه روزی: ۰۲۱-۸۸۸۶۲۰۸۵

FarmaSOS.com

### 3-3. Using the “touch screen” Using the Bluetooth® phone

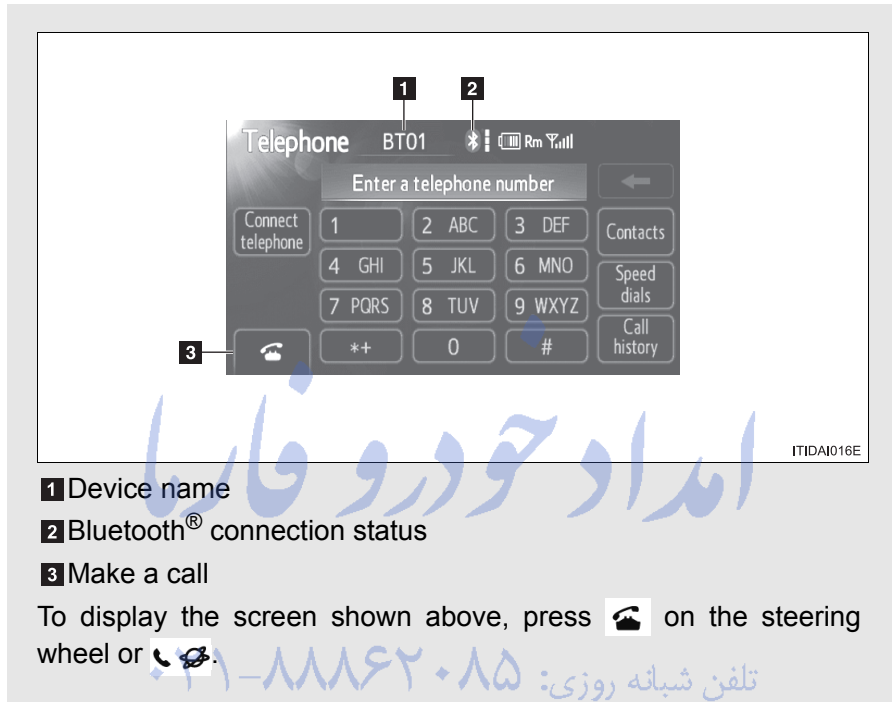

3

Interior features

FarmaSOS.com

### Registering a Bluetooth® phone

To use the hands-free system, you must register a Bluetooth® phone in the system. You can register up to 5 phones in the system.

**STEP 1** Display the “Telephone” screen. (→P. 395)

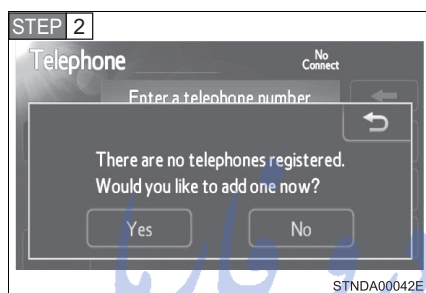

Touch “Yes”.

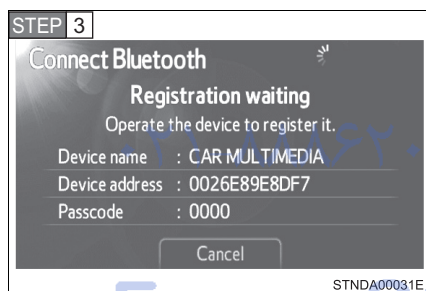

Input the passcode displayed on the screen into your phone.

For the operation of the phone, see the manual that comes with your cellular phone.

Passcodes are not required for SSP (Secure Simple Pairing) compatible Bluetooth® devices. Depending on the phone, you may need to select “Yes” to register, or “No” to cancel on your cellular phone.

If you want to cancel it, select “Cancel”.

If a completion message is displayed, registration is complete.

If an error message is displayed, follow the guidance on the screen to try again.

**Selecting the Bluetooth® phone**

If multiple Bluetooth® devices are registered, follow the procedure below to select the Bluetooth® device to be used. You may only use one device at a time.

**STEP 1** Display the “Telephone” screen. (→P. 395)



Touch “Connect telephone”.

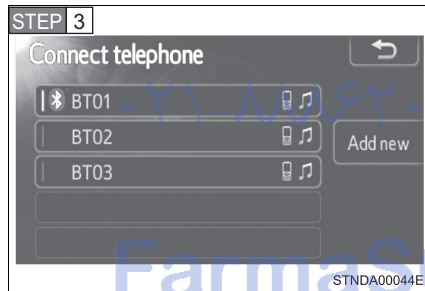

Touch the device to connect.

“Add new”: Registering a Bluetooth® device. (→P. 429)

The selection indicator is displayed on left side of the selected device name.

The Bluetooth® mark is displayed when you connected the device.

### Connecting a Bluetooth® phone

There are two connecting methods available-automatic and manual.

#### **Automatic**

When you register your phone, auto connection will be activated. Always set it to this mode and leave the Bluetooth® phone in a place where connection can be established.

When the engine switch is turned to the “ACC” or “ON” position, the system will search for a nearby cellular phone you have registered. Next, the system automatically connects with the most recent of the phones connected to in the past. Then, the connection result is displayed.

تلفن شبانه روزی: ۰۸۵-۸۸۸۶۲-۰۲۱

FarmaSOS.com

### Manual

When the auto connection has failed or “Bluetooth\* power” is turned off, you must connect Bluetooth® manually.

**STEP 1** Display the “Telephone” screen. (→P. 395)



Touch “Connect telephone”.

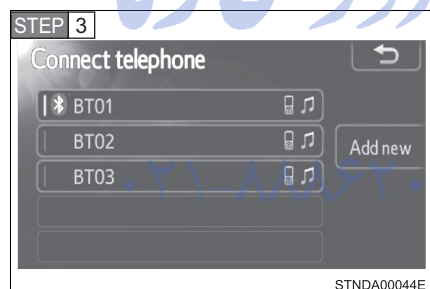

Touch the device to connect.

A message is shown if connection has been successful.

If connection fails, a message will be displayed and connection will be re-attempted.

\*: Bluetooth is a registered trademark of Bluetooth SIG. Inc.

#### ■ Reconnecting to the Bluetooth® phone

If the system cannot connect due to poor signal strength with the engine switch in the “ACC” or “ON” position, the system will automatically attempt to reconnect.

If the phone is turned off, the system will not attempt to reconnect. In this case, connection must be made manually, or the phone must be re-selected.

#### ■ Connecting the phone while Bluetooth® audio is playing

- Bluetooth® audio will stop temporarily.
- It may take time to connect.

### Making a call

Once the Bluetooth® phone is registered, you can make a call using the following procedure:

#### ■ Dialing



**STEP 1** Display the “Telephone” screen. (→P. 395)



Input the phone number.

To delete the inputted phone number, touch .

For the first digit, you can enter “+” by touching “\*” for a while.

**STEP 3** Press  on the steering wheel or touch .



■ **Dialing from the phonebook**

You can dial a number from the phonebook data imported from your mobile phone. The system has one phonebook for each telephone. Up to 1000 entries may be stored in each phonebook. (→P. 414)

**STEP 1** Display the “Telephone” screen. (→P. 395)

**STEP 2** Touch “Contacts” on the “Telephone” screen.

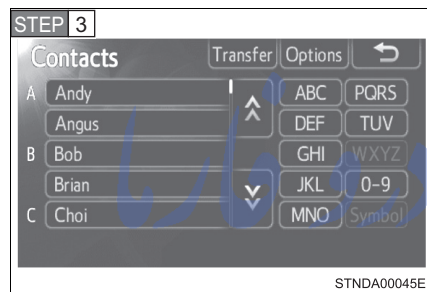

Choose the desired data to call from the list.

If the phonebook is empty, a message will be displayed. (→P. 402)

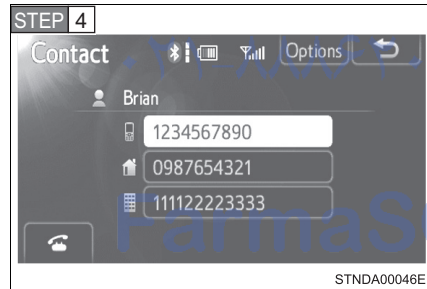

Choose the number and then press on the steering wheel or touch .

3

Interior features

### 3-3. Using the “touch screen”

- When the phonebook is empty

You can transfer the phone numbers in your Bluetooth® phone to the system.

Operation methods differ between PBAP compatible and PBAP incompatible Bluetooth® phones. If your cellular phone does not support either PBAP or OPP service, you cannot transfer contacts.

**STEP 1** Touch “Contacts” on the “Telephone” screen.



If the phonebook is empty, a message will be displayed.

#### **For PBAP compatible Bluetooth® phone**

**STEP 3** Touch “Yes” if you want to transfer new contacts from a cellular phone.

Touch “No” if you want to cancel transferring the contacts.

This operation may be unnecessary depending on the cellular phone model.

#### **For PBAP incompatible and OPP compatible Bluetooth® phone**

**STEP 3** Touch “Transfer” if you want to transfer new contacts from a cellular phone.

Touch “Cancel” if you want to cancel transferring the contacts.

You need to operate your phone to transfer new contacts.

### ■ Calling using speed dial

You can make a call using numbers registered from the phone-book.

**STEP 1** Display the “Telephone” screen. (→P. 395)

**STEP 2** Touch “Speed dials” on the “Telephone” screen.

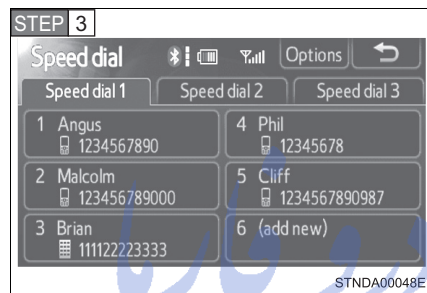

Select the desired tab and choose the desired number to make a call.

تلفن شبانه روزی: ۰۲۱-۸۸۶۲۰۸۵

FarmaSOS.com

### 3-3. Using the "touch screen"

#### ■ Dialing from history

You can call using the call history which has the 4 functions below.

"All": all the calls below which were memorized

"Missed": calls which you missed

"Incoming": calls which you received

"Outgoing": calls which you called

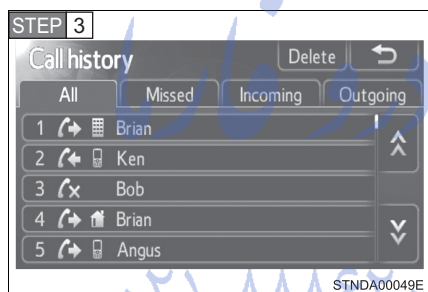

**STEP 1** Display the "Telephone" screen. (→P. 395)

**STEP 2** Touch "Call history" on the "Telephone" screen.

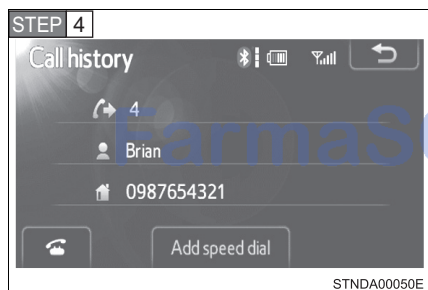

Select the desired tab and choose the desired data from the list.



Press  on the steering wheel or touch .





■ **Call history list**

- If you make a call to or receive a call from a number registered in the phonebook, the name is displayed in the call history.
- If you make multiple calls to the same number, only the last call made is displayed in the call history.

■ **International calls**

You may not be able to make international calls, depending on the mobile phone in use.

■ **Calling by using the latest call history item**

- STEP 1** Press  on the steering wheel to display the "Telephone" screen.
- STEP 2** Press  on the steering wheel to display the "Call history" screen.
- STEP 3** Press  on the steering wheel to select the latest history item.
- STEP 4** Press  on the steering wheel or touch  to call the latest history item.

تلفن شبانه روزی: ۰۲۱-۸۸۶۲۰۸۵

FarmaSOS.com



### 3-3. Using the “touch screen”

#### Receiving a call

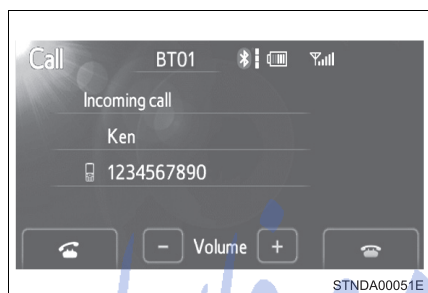
When a call is received, the following screen is displayed together with a sound.



To answer the phone:

- Press  on the steering wheel.
- Touch .

#### ■ To refuse a call

Press  on the steering wheel or touch .

#### ■ To adjust the incoming call volume

Touch “-” or “+”. You can also adjust the volume using the steering switches or volume knob.

#### ■ International calls

Received international calls may not be displayed correctly depending on the cellular phone in use.

### Speaking on the phone

The following screen is displayed when speaking on the phone.

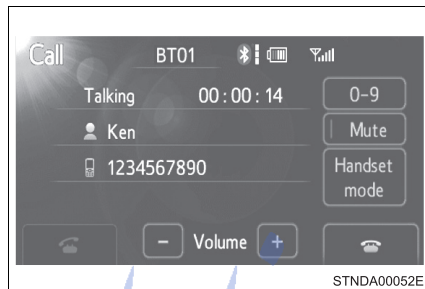

- **To adjust the incoming call volume**  
Touch “-” or “+”. You can also adjust the volume using the steering switches or the volume knob.
- **To prevent the other party from hearing your voice**  
Touch “Mute”.

تلفن شبانه روزی: ۰۲۱-۸۸۶۲۰۸۵

FarmaSOS.com

### 3-3. Using the “touch screen”

#### ■ Inputting tones

When using phone services such as an answering service or a bank, you can store phone numbers and code numbers in the phonebook.

**STEP 1** Touch “0-9”.

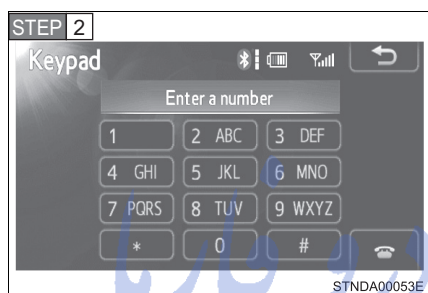

Input the number.

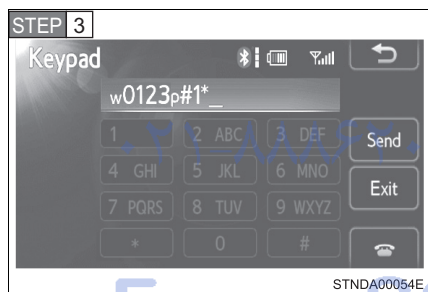

If repeated tone symbols\* are stored in the phone book, “Send” and “Exit” are displayed on the right side of the screen.

\*: Repeated tone symbols are symbols or numbers displayed as p or w, that come after the phone number. (e.g. 056133w0123p#1\*)

**STEP 4** Confirm the number displayed on the screen, and touch “Send”.

If you touch “Exit”, this function will end.



### ■ To transfer a call

Touch “Handset Mode” to change from Hands-free call to cellular phone call.

Touch “Handsfree Mode” to change from cellular phone call to Hands-free call.

### ■ To hang up

Press  on the steering wheel or touch .

### ■ Call waiting

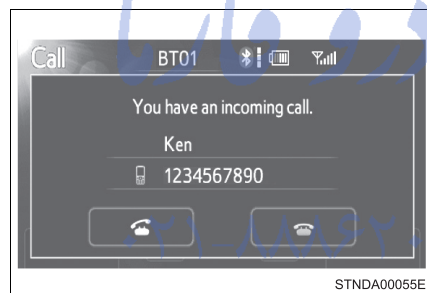

When a call is interrupted by a third party while talking, the incoming call message will be displayed.





To talk with the other party:

- Press  on the steering wheel.
- Touch .

To refuse the call:

- Press  on the steering wheel.
- Touch .

Every time you press  on the steering wheel or touch  during call waiting, you will be switched to the other party.

---

■ **Transferring calls**

- It is not possible to transfer from hands-free to the cellular phone while driving.
- If you transfer from the cellular phone to hands-free, the hands-free screen will be displayed, and you can operate the system using the screen.
- Transfer method and operate may vary according to the cellular phone used.
- For operation of the cellular phone in use, see the phone's manual.

■ **Call waiting operation**

Call waiting operation may differ depending on your phone company and cellular phone.

تلفن شبانه روزی: ۰۲۱-۸۸۸۶۲۰۸۵

FarmaSOS.com

### 3-3. Using the “touch screen” Setting the hands-free system

You can set the hands-free system to your desired settings.

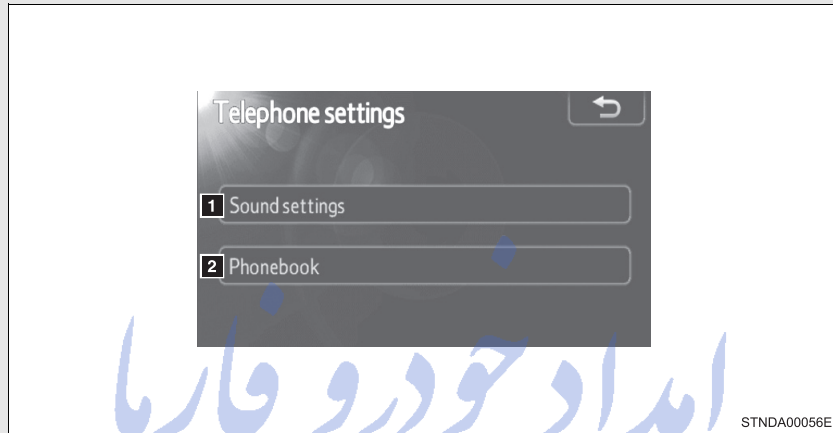

- 1 Setting the sound
- 2 Phonebook settings

To display the screen shown above, press “SETUP”, and touch “Telephone” on the “Setup” screen.

FarmaSOS.com

3

Interior features

### 3-3. Using the “touch screen”

#### Setting the sound

**STEP 1** Display the “Telephone settings” screen. (→P. 411)

**STEP 2** Touch “Sound settings” on the “Telephone settings” screen.

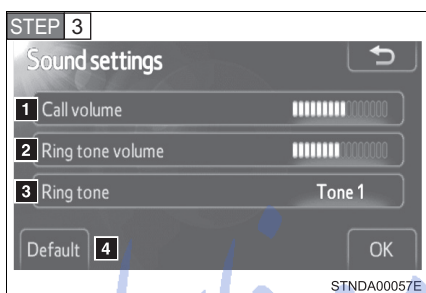

**1** Changes the speaker volume (→P. 412)

**2** Changes the ring tone volume (→P. 412)

**3** Changes the ring tone (→P. 413)

**4** Restore default settings

#### Setting the volume

**STEP 1** Touch “Call volume” or “Ring tone volume” on the “Sound settings” screen.

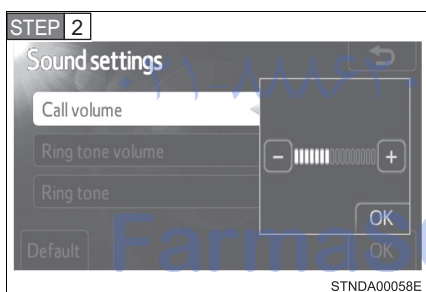

Touch “-” or “+” to lower or raise the volume, and then “OK”.

**STEP 3** When you complete all settings, touch “OK”.

■ **Setting the ring tone**

**STEP 1** Touch "Ring tone" on the "Sound settings" screen.

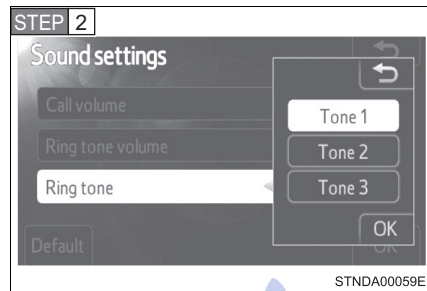

Touch "Tone 1", "Tone 2" or "Tone 3" to change the ring tone, and then "OK".

**STEP 3** When you complete all settings, touch "OK".

■ **To return to the default volume settings**

Touch "Default", and then "Yes".

تلفن شبانه روزی: ۰۲۱-۸۸۶۲۰۸۵

FarmaSOS.com

### 3-3. Using the “touch screen”

#### Phonebook settings

The phonebook manages a maximum of 5 phones in total. The data for 1000 contacts (up to 3 numbers per contact) can be registered in each phonebook.

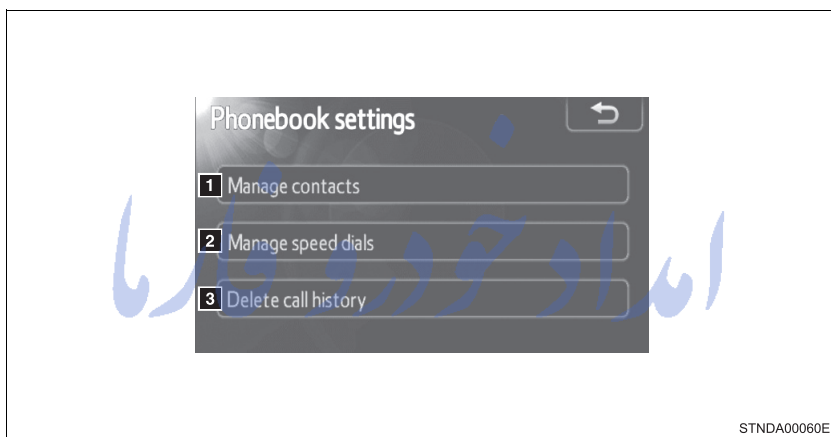

**1** Managing the contacts

**2** Managing the speed dials

**3** Deleting the call history

To display the screen above, follow the steps below.

**STEP 1** Display the “Telephone settings” screen. (→P. 411)

**STEP 2** Touch “Phonebook” on the “Telephone settings” screen.

### ■ Managing the contacts

#### ● Transferring a phone number

You can transfer the phone numbers in your Bluetooth® phone to the system. Operation methods differ between PBAP compatible and PBAP incompatible Bluetooth® phones. If your cellular phone does not support either PBAP or OPP services, you cannot transfer contacts.

**STEP 1** Display the “Phonebook settings” screen. (→P. 411)

**STEP 2** Touch “Manage contacts” on the “Phonebook settings” screen.

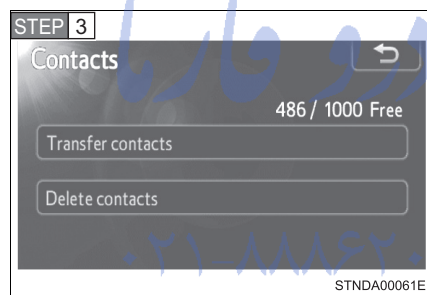

Touch “Transfer contacts”.

FarmaSOS.com

### 3-3. Using the "touch screen"

#### For PBAP compatible Bluetooth® phones

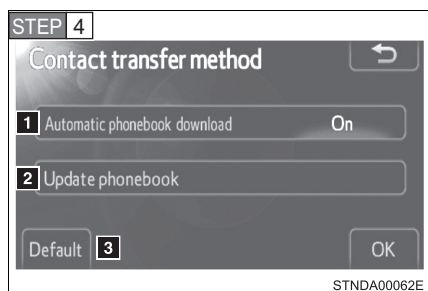

##### 1 Automatic phonebook download on/off

The phonebook data can be automatically transferred.

Depending on the cellular phone, call history will be also transferred.

##### 2 Update phonebook

The phonebook data can be updated.

##### 3 Restore default settings

#### For PBAP incompatible Bluetooth® phones

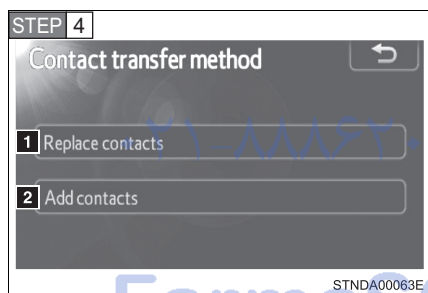

##### 1 Replace contacts

The phonebook data can be replaced.

##### 2 Add contacts

The phonebook can be added.



- Deleting the phonebook data

**STEP 1** Display the "Phonebook settings" screen. (→P. 414)

**STEP 2** Touch "Manage contacts" on the "Phonebook settings" screen.

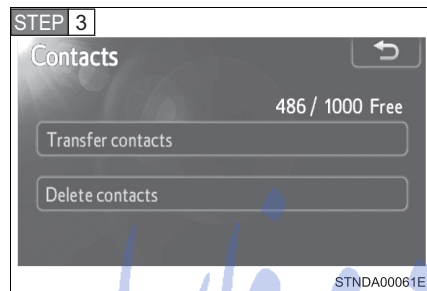

Touch "Delete contacts".

If your phone supports PBAP service, "Automatic phonebook download" setting needs to be set to "Off". (→P. 415)

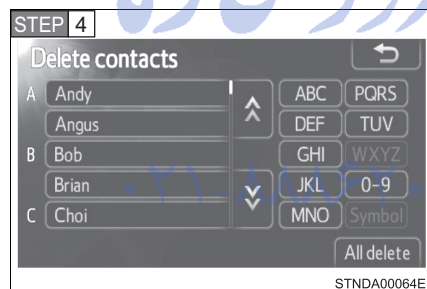

Choose the data to delete.

To delete all data, touch "All delete".

**STEP 5** A confirmation message will be displayed. If everything is correct, touch "Yes".

---

■ **Phonebook data**

Phonebook data is managed for every registered phone. When another phone is connecting, you cannot read the registered data.

■ **Setting the phonebook in a different way (To display the “Contacts” screen)**

**STEP 1** Display the “Telephone” screen. (→P. 395)

**STEP 3** Touch “Contacts” on the “Telephone” screen.

**STEP 3** Touch “Options” on the “Contacts” screen.

**STEP 4** Touch “Manage contacts” on the “Phonebook settings” screen.

■ **When transferring a phone number**

Transfer the phone number while engine is running.  
If your cellular phone is OPP or PBAP compatible, you may need to input “1234” by your cellular phone for OBEX certification.

■ **When you have selected “Update phonebook” to transfer the phone number**

- If your cellular phone does not support PBAP service, you cannot use this function.
- If your phone supports PBAP service, you can transfer the phonebook data without operating your phone.

■ **When you have selected “Replace contacts” or “Add contacts” to transfer the phone number**

If your cellular phone does not support OPP service, you cannot use these functions. You can transfer the phonebook data only by operating your phone.

■ **Transferring the phone number in a different way (To display the "Contact transfer method" screen)**

- STEP 1** Display the "Telephone" screen. (→P. 395)
- STEP 2** Touch "Contacts" on the "Telephone" screen.
- STEP 3** Touch "Transfer" on the "Contacts" screen.

■ **Transferring the phone number while Bluetooth® audio is playing**

Bluetooth® audio will disconnect. It will reconnect automatically when data transfer finishes. It will not be reconnected depending on the phone you are using.

■ **Deleting the phonebook data in a different way**

- STEP 1** Display the "Telephone" screen. (→P. 395)
- STEP 2** Touch "Contacts" on the "Telephone" screen.
- STEP 3** Choose the desired data from the list.
- STEP 4** Touch "Options" on the "Contact" screen.
- STEP 5** Touch "Delete" on the "Contact data" screen.
- STEP 6** A confirmation message will be displayed. If everything is correct, touch "Yes".

If your phone supports PBAP service, "Automatic phonebook download" setting needs to be set to "Off". (→P. 415)

When you delete a Bluetooth® phone, the phonebook data will be deleted at the same time.

### 3-3. Using the “touch screen”

#### ■ Managing the speed dials

##### ● Registering the speed dial from contacts

You can register the desired phone number from phonebook. Up to 18 numbers per phone can be registered.

**STEP 1** Display the “Phonebook settings” screen. (→P. 414)

**STEP 2** Touch “Manage speed dials” on the “Phonebook settings” screen.

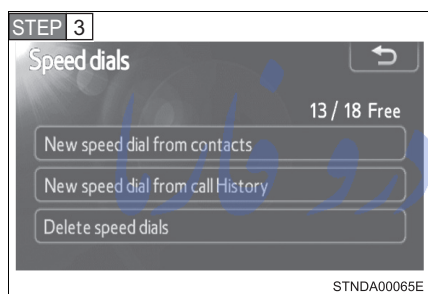

Touch “New speed dial from contacts”.

تلفن شبانه روزی: ۰۲۱-۸۸۸۶۲۰۸۵

FarmaSOS.com

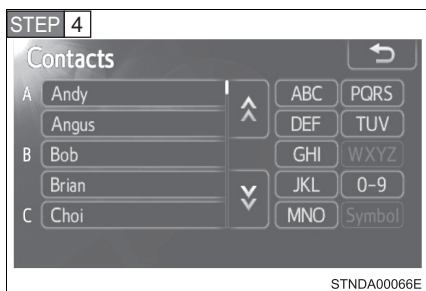

Choose the data to register.

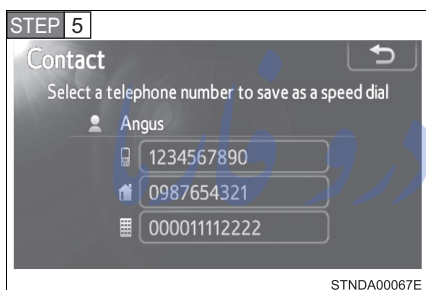

Touch the desired phone number.

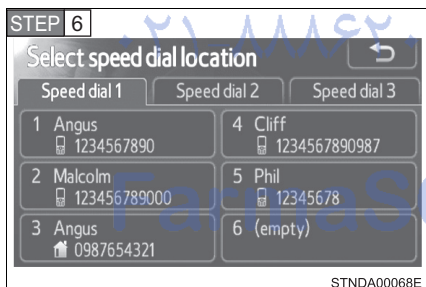

Touch the switch you want to register the number in.

STEP 7 If you select a switch you registered before, a confirmation message will be displayed. If you want to replace it, touch "Yes".

### 3-3. Using the "touch screen"

- Registering the speed dial from call history

**STEP 1** Display the "Phonebook settings" screen. (→P. 414)

**STEP 2** Touch "Manage speed dials" on the "Phonebook settings" screen.

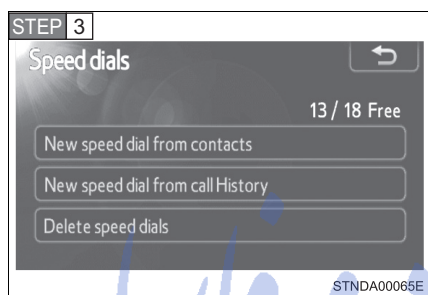

Touch "New speed dial from call History".

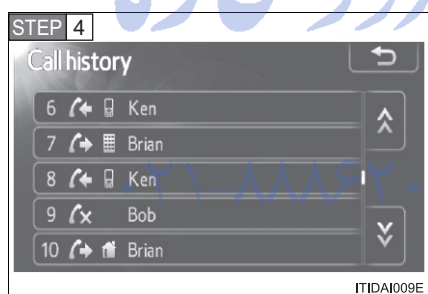

Choose the data to register.

FarmaSOS.com

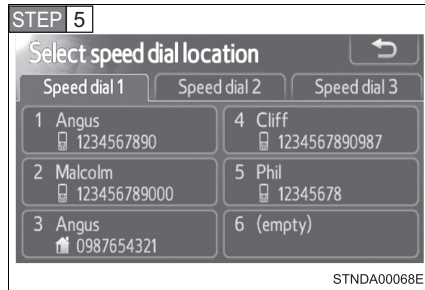

Touch the switch you want to register the number in.

STEP 6 If you select a switch you registered before, a confirmation message will be displayed. If you want to replace it, touch "Yes".

- Deleting the speed dial

STEP 1 Display the "Phonebook settings" screen. (→P. 414)

STEP 2 Touch "Manage speed dials" on the "Phonebook settings" screen.

STEP 3 Touch "Delete speed dials" on the "Speed dials" screen.

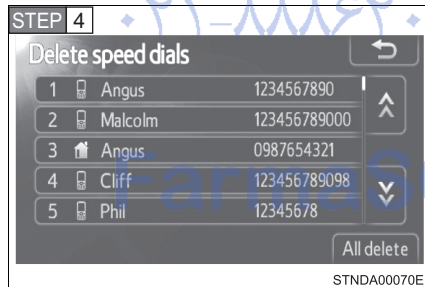

Choose the data to delete. To delete all data, touch "All delete".

STEP 5 A confirmation message will be displayed. If everything is correct, touch "Yes".

■ **Setting the speed dials in a different way (From "Speed dial" screen)**

- STEP 1 Display the "Telephone" screen. (→P. 395)
- STEP 2 Touch "Speed dials" on the "Telephone" screen.
- STEP 3 Touch "Options" on the "Speed dial" screen.

■ **Setting the speed dials in a different way (From "Contacts" screen)**

- STEP 1 Display the "Telephone" screen. (→P. 395)
- STEP 2 Touch "Contacts" on the "Telephone" screen.
- STEP 3 Touch "Options" on the "Contacts" screen.
- STEP 4 Touch "Manage speed dials" on the "Phonebook settings" screen.

■ **Registering the speed dial in a different way (From "Speed dial" screen)**

- STEP 1 Display the "Telephone" screen. (→P. 395)
- STEP 2 Touch "Speed dials" on the "Telephone" screen.
- STEP 3 Touch "(add new)" on the "Speed dial" screen.
- STEP 4 Touch "Contacts" or "History" to set new speed dial.  
Touch "Cancel" to cancel it.
- STEP 5 Choose the desired data from the list.
- STEP 6 Touch the desired phone number.
- STEP 7 Follow the steps "Registering the speed dial from contacts" from "STEP6" (→P. 420) or "Registering the speed dial from call history" from "STEP5". (→P. 422)



■ **Registering the speed dial in a different way (From "Contact" screen)**

- STEP 1** Display the "Telephone" screen. (→P. 395)
- STEP 2** Touch "Contacts" on the "Telephone" screen.
- STEP 3** Choose the desired data from the list.
- STEP 4** Touch "Options" on the "Contact" screen.
- STEP 5** Touch "Set speed dial" on the "Contact data" screen.
- STEP 6** Touch the desired telephone number.
- STEP 7** Follow the steps "Registering the speed dial from contacts" from "STEP6" (→P. 420) or "Registering the speed dial from call history" from "STEP5". (→P. 422)

■ **Registering the speed dial in a different way (From "Call history" screen)**

- STEP 1** Display the "Telephone" screen. (→P. 395)
- STEP 2** Touch "Call history" on the "Telephone" screen.
- STEP 3** Choose the desired data from the list.
- STEP 4** Touch "Add speed dial" on the "Call history" screen.
- STEP 5** Follow the steps "Registering the speed dial from contacts" from "STEP6" (→P. 420) or "Registering the speed dial from call history" from "STEP5". (→P. 422)

FarmaSOS.com

### 3-3. Using the “touch screen”

#### ■ Deleting the call history

**STEP 1** Display the “Phonebook settings” screen. (→P. 414)

**STEP 2** Touch “Delete call history” on the “Phonebook settings” screen.

If your phone supports PBAP service, the “Automatic phonebook download” setting needs to be set to “Off”. (→P. 415)

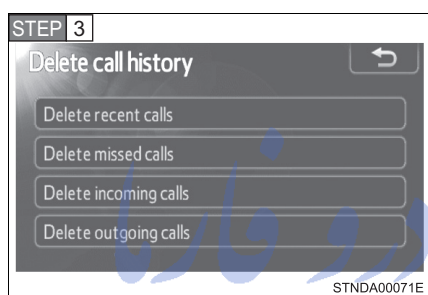

Choose the desired history to delete.

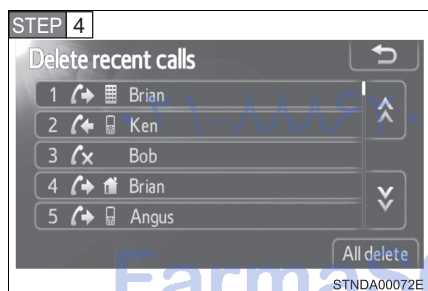

Choose the data to delete.  
To delete all data, touch “All delete”.

**STEP 5** A confirmation message will be displayed. If everything is correct, touch “Yes”.

■ **Deleting call history in a different way**

- STEP 1** Display the "Telephone" screen. (→P. 395)
- STEP 2** Touch "Call history" on the "Telephone" screen.
- STEP 3** Touch "Delete" on the "Call history" screen.
- STEP 4** Follow the steps "Deleting the call history" from "STEP4". (→P. 426)

امداد خودرو فارما

تلفن شبانه روزی: ۰۲۱-۸۸۸۶۲۰۸۵

FarmaSOS.com

### 3-3. Using the “touch screen” Bluetooth® settings

You can set the Bluetooth® system to your desired settings.



**1** Registered devices settings

**2** Connecting telephone

**3** Connecting audio player

**4** Detailed Bluetooth® settings

To display the screen shown above, press “SETUP”, and touch “Bluetooth\*” on the “Setup” screen.

\*: Bluetooth is a registered trademark of Bluetooth SIG. Inc.

### Registered devices settings

#### ■ Registering a Bluetooth® device

Bluetooth® devices compatible with phones (HFP) and portable audio players (AVP) can be registered simultaneously. You can register up to 5 Bluetooth® devices.

**STEP 1** Display the “Bluetooth\* Settings” screen. (→P. 428)

**STEP 2** Touch “Registered devices” on the “Bluetooth\* Settings” screen.

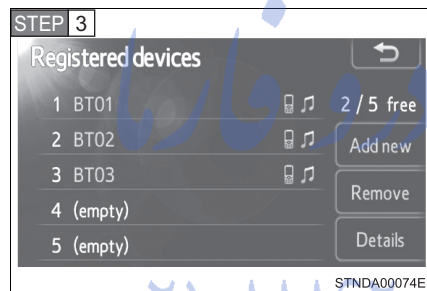

Touch “Add new”.

\*: Bluetooth is a registered trademark of Bluetooth SIG, Inc. تلفن شماره ۰۲۱-۸۸۸۸۸۸۸۸

### 3-3. Using the “touch screen”

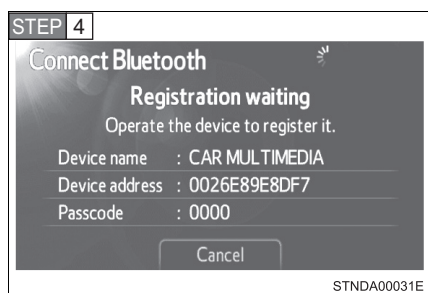

When this screen is displayed, input the passcode displayed on the screen into your Bluetooth® device.

For the operation of the Bluetooth® device, see the manual that comes with your Bluetooth® device.

Passcodes are not required for SSP (Secure Simple Pairing) compatible Bluetooth® devices. Depending on the phone, you may need to select “Yes” to register, or “No” to cancel on your cellular phone.

If you want to cancel it, touch “Cancel”.

If a completion message is displayed, registration is complete.

If an error message is displayed, follow the guidance on the screen to try again.

■ **Removing a Bluetooth® device**

**STEP 1** Display the "Bluetooth\* Settings" screen. (→P. 428)

**STEP 2** Touch "Registered devices" on the "Bluetooth\* Settings" screen.

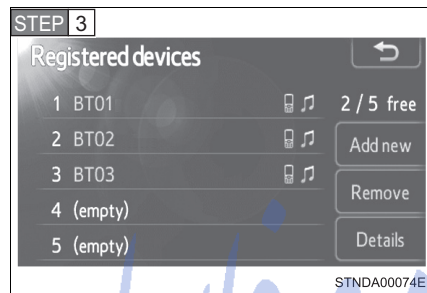

Touch "Remove".

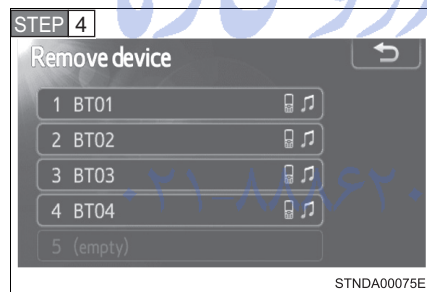

Touch the device to remove.

**STEP 5** A confirmation message will be displayed, touch "Yes" to remove the device.

\*: Bluetooth is a registered trademark of Bluetooth SIG, Inc.

### 3-3. Using the “touch screen”

#### ■ Displaying a Bluetooth® device details

You can confirm and change the device details.

**STEP 1** Display the “Bluetooth\* Settings” screen. (→P. 428)

**STEP 2** Touch “Registered devices” on the “Bluetooth\* Settings” screen.

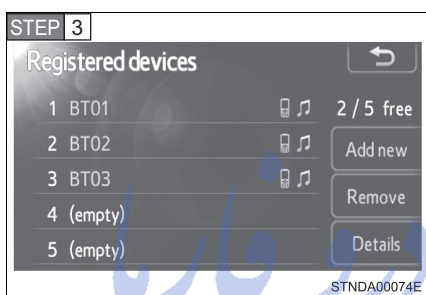

Touch “Details”.

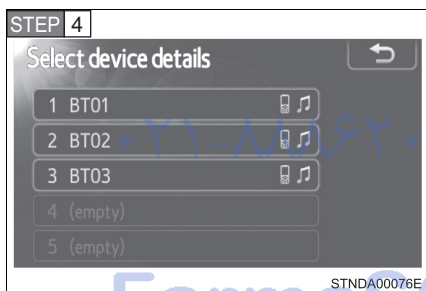

Touch the device.

\*: Bluetooth is a registered trademark of Bluetooth SIG. Inc.



**STEP 5** Following screen is displayed:

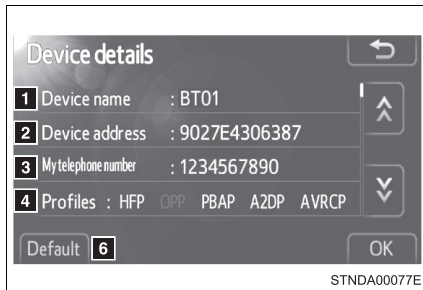

- 1** Display device name
- 2** Display device address
- 3** Display your telephone number  
The number may not be displayed depending on the phones.

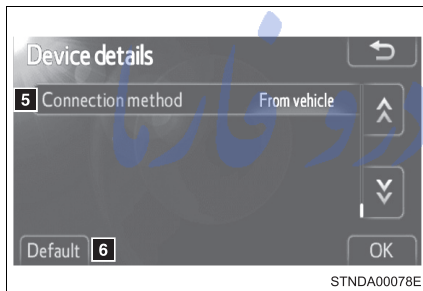

- 4** Display compatibility profile of the device
- 5** Change connection method (→P. 433)
- 6** Restore default settings

**STEP 6** When you complete settings, touch “OK” تلفن شبانه روزی

- Changing connection method

**STEP 1** Touch “Connection method” on the “Device details” screen.

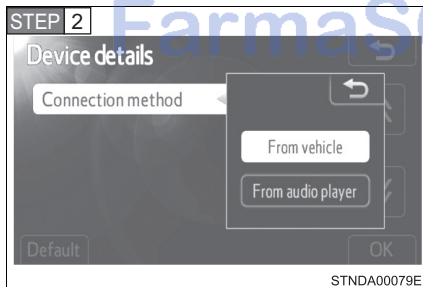

**STEP 2** Touch “From vehicle” or “From audio player”.

“From vehicle”: Connect the audio system to the portable audio player.

“From audio player”: Connect the portable audio player to the audio system.

### Selecting the Bluetooth® phone

If multiple Bluetooth® devices are registered, follow the procedure below to select the Bluetooth® device to be used. You may only use one device at a time.

**STEP 1** Display the “Bluetooth\* Settings” screen. (→P. 428)

**STEP 2** Touch “Connect telephone” on the “Bluetooth\* Settings” screen.

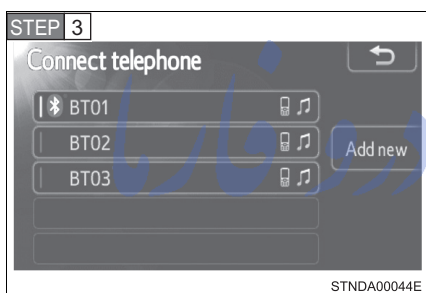

Touch the device to connect.

“Add new”: Registering a Bluetooth® device. (→P. 429)

The selection indicator is displayed on left side of the selected device name.

The Bluetooth® mark is displayed when you connected the device.

\*: Bluetooth is a registered trademark of Bluetooth SIG, Inc.

تلفن شبانه روزی: ۰۸۵-۸۸۶۲-۲۱

FarmaSOS.com

### Selecting the audio player

If multiple Bluetooth® devices are registered, follow the procedure below to select the Bluetooth® device to be used. You may only use one device at a time.

**STEP 1** Display the “Bluetooth\* Settings” screen. (→P. 428)

**STEP 2** Touch “Connect audio player” on the “Bluetooth\* Settings” screen.

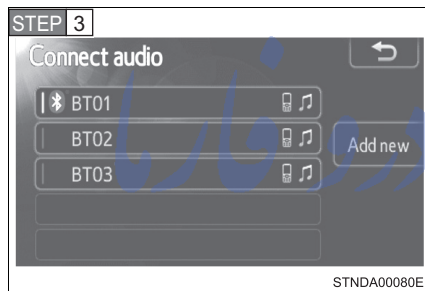

Touch the device to connect.

“Add new”: Registering a Bluetooth® device. (→P. 429)

The selection indicator is displayed on left side of the selected device name.

The Bluetooth® mark is displayed when you connected the device.

\*: Bluetooth is a registered trademark of Bluetooth SIG. Inc.

### Detailed Bluetooth® settings

You can confirm and change the detailed Bluetooth® settings.

**STEP 1** Display the “Bluetooth\* Settings” screen. (→P. 428)

**STEP 2** Touch “Detailed Bluetooth\* settings” on the “Bluetooth\* Settings” screen.

\*: Bluetooth is a registered trademark of Bluetooth SIG. Inc.

### 3-3. Using the “touch screen”

**STEP 3** Following screen is displayed:

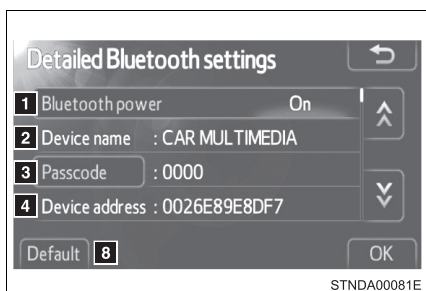

**1** Change Bluetooth<sup>®</sup> power on/off

You can change Bluetooth<sup>®</sup> function to “On” or “Off”

**2** Display device name

**3** Change passcode (→P. 437)

**4** Display device address

**5** Display compatibility profile of the system

**6** Change displaying telephone status on/off

You can set the system to show the status confirmation display when connecting telephone

**7** Change displaying audio player status on/off

You can set the system to show the status confirmation display when connecting audio player

**8** Restore default settings

**STEP 4** When you complete settings, touch “OK”.

### ■ Editing the passcode

You can change the passcode that you use to register your Bluetooth® device in the system.

**STEP 1** Touch “Passcode” on the “Detailed Bluetooth\* settings” screen.

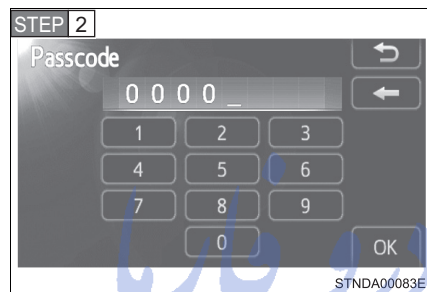

Input a passcode, and touch “OK”.

\*: Bluetooth is a registered trademark of Bluetooth SIG. Inc.

تلفن شبانه روزی: ۰۲۱-۸۸۶۲۰۸۵

FarmaSOS.com

### 3-4. Using the interior lights

## Interior lights list

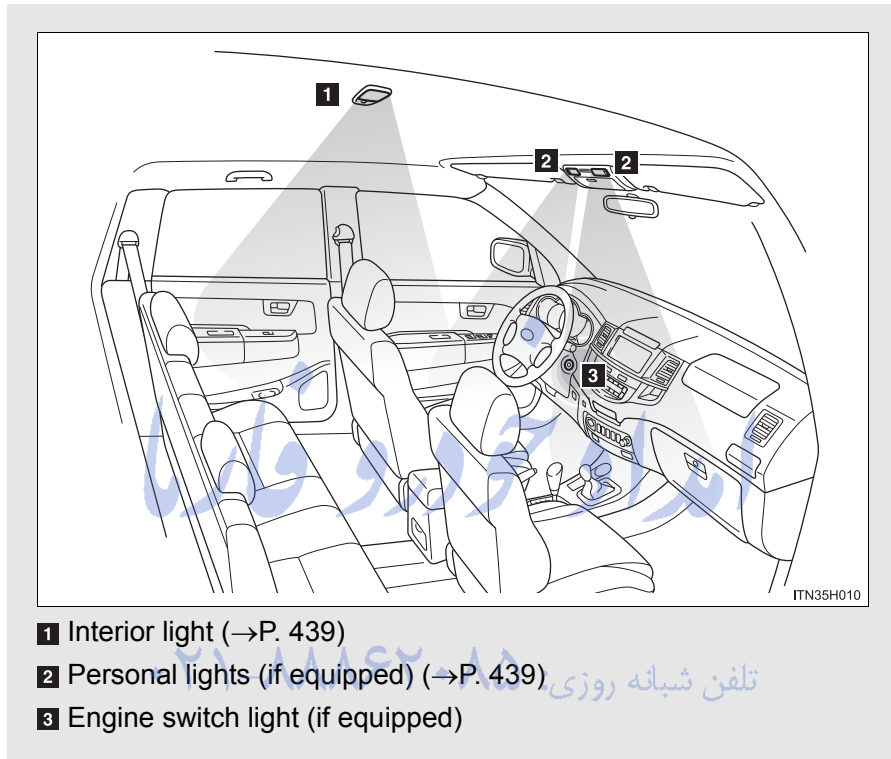

FarmaSOS.com

**Personal lights (if equipped)**

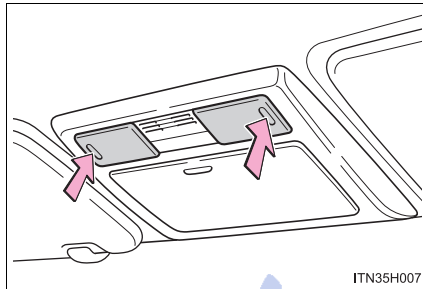

Turns the lights on/off

**Interior light**

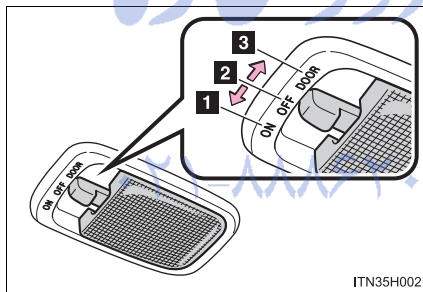

- 1 Turns the light on
- 2 Turns the light off
- 3 Turns the door position on

■ **Illuminated entry system (if equipped)**

**Type A**

The lights turn on/off automatically with the opening/closing of the doors.

**Type B**

The lights automatically turn on/off according to the engine switch position, whether the doors are locked/unlocked, and whether the doors are open/closed.

### 3-5. Using the storage features

## List of storage features

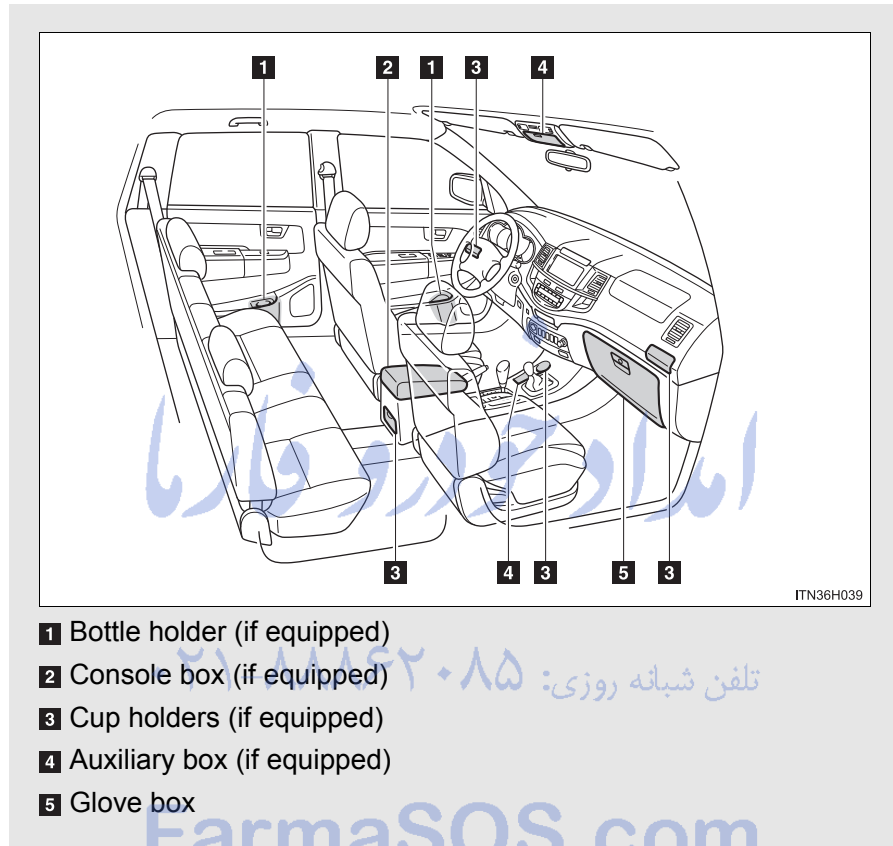



 CAUTION

■ **Items that should not be left in the storage spaces**

Do not leave glasses, lighters or spray cans in the storage spaces, as this may cause the following when cabin temperature becomes high:

- Glasses may be deformed by heat or cracked if they come into contact with other stored items.
- Lighters or spray cans may explode. If they come into contact with other stored items, the lighter may catch fire or the spray can may release gas, causing a fire hazard.

امداد خودرو فارما

تلفن شبانه روزی: ۰۲۱-۸۸۶۲۰۸۵

FarmaSOS.com

**Glove box**

The glove box can be opened by pulling the lever, locked and unlocked by using the master key.

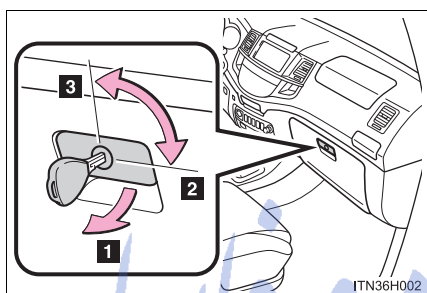

- 1** Open
- 2** Lock
- 3** Unlock

**⚠ CAUTION****■ Caution while driving**

Keep the glove box closed. In the event of sudden braking or sudden swerving, an accident may occur due to an occupant being struck by the open glove box or the items stored inside.

FarmaSOS.com

**Console box (if equipped)**

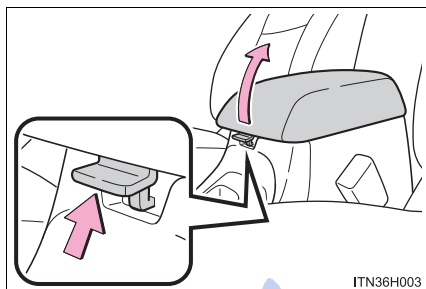

Lift the lid while pulling up the knob to release the lock.

**⚠ CAUTION**

**■ Caution while driving**

Keep the console box closed. In the event of sudden braking or sudden swerving, an accident may occur due to an occupant being struck by the open console box or the items stored inside.

تلفن شبانه روزی: ۰۲۱-۸۸۶۲۰۸۵

FarmaSOS.com

**Cup holders**

**Type A (instrument panel)**

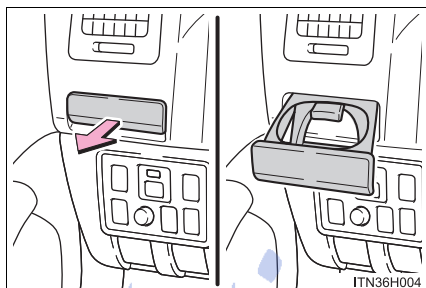

Pull out the cup holder completely.

Lift the tray up before returning.

**Type B (console box) (if equipped)**

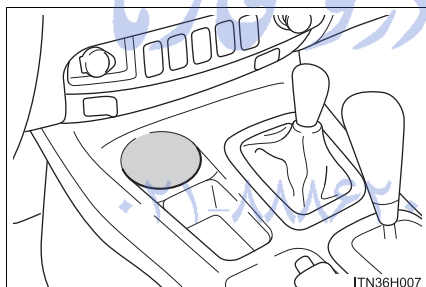

**Type C (console box) (if equipped)**

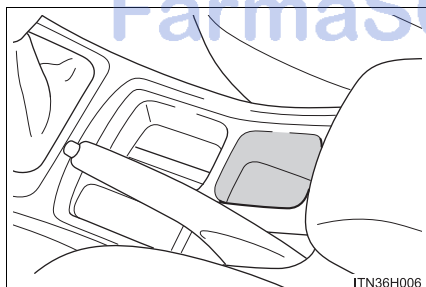

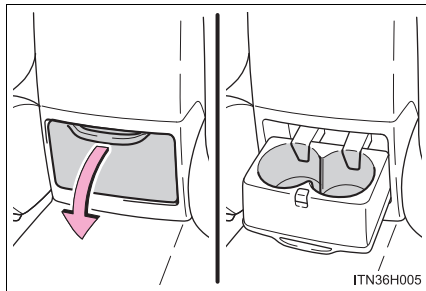
**Type D (rear console box) (if equipped)**

Pull the lid.

**⚠ CAUTION****■ Items unsuitable for the cup holder**

Do not place anything other than cups or beverage cans in the cup holders. Other items may be thrown out of the holders in the event of sudden braking, sudden swerving or an accident, cause injury. If possible, cover hot drinks to prevent burns.

**■ When not in use (type A and D)**

Keep the cup holders closed. In the event of sudden braking or sudden swerving, an accident may occur due to an occupant being struck by the open cup holders or the items stored inside.

### Bottle holders

#### For front seats

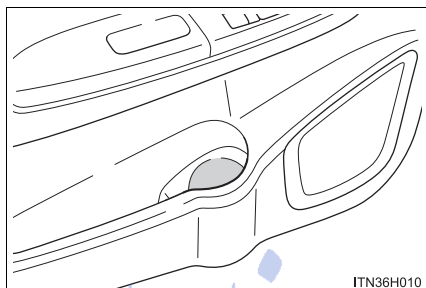

#### For rear seats (if equipped)

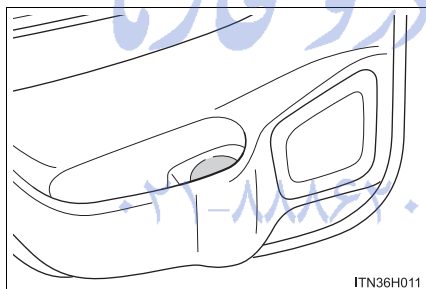

#### ■ When using the holder as a bottle holder

- When storing a bottle, close the cap.
- The bottle may not be stored depending on its size or shape.

#### ⚠ NOTICE

#### ■ Items that should not be stowed in the bottle holders

Do not place open bottles in the bottle holders, or glasses and paper cups containing liquid. The contents may spill and glasses may break.

**Auxiliary boxes**

**Type A (if equipped)**

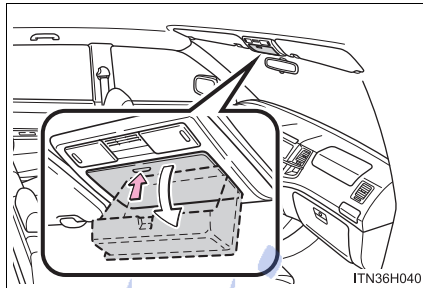

Press in the lid.

The auxiliary box is useful for temporarily storing sunglasses and similar small items.

**Type B (if equipped)**

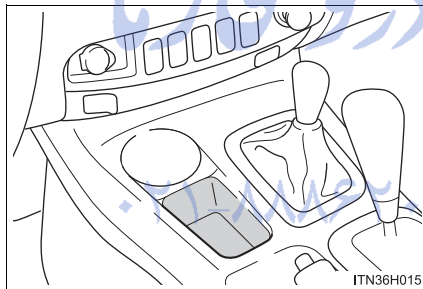

**Type C (if equipped)**

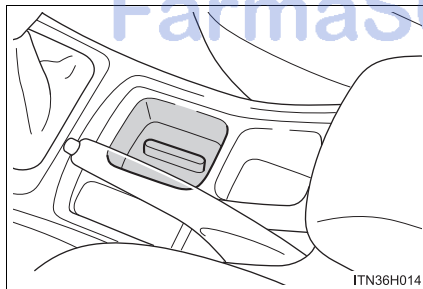

 CAUTION

■ **Caution while driving (type A)**

Keep the auxiliary boxes closed. In the event of sudden braking or sudden swerving, an accident may occur due to an occupant being struck by an open auxiliary box or the items stored inside.

■ **Items unsuitable for storing (type A)**

Do not store items heavier than 0.2 kg (0.4 lb.).  
Doing so may cause the auxiliary box to open and the items inside may fall out, resulting in an accident.

امداد خودرو فارما

تلفن شبانه روزی: ۰۲۱-۸۸۸۶۲۰۸۵

FarmaSOS.com



### 3-6. Other interior features

## Sun visors

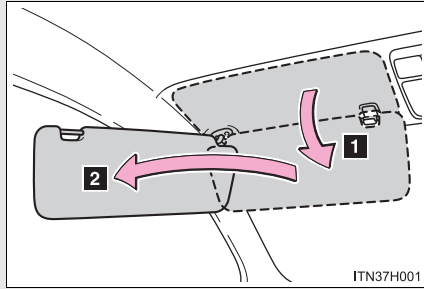

- 1** To set the visor in the forward position, flip it down.
- 2** To set the visor in the side position, flip down, unhook, and swing it to the side.

امداد خودرو فارما

تلفن شبانه روزی: ۰۲۱-۸۸۶۲۰۸۵

FarmaSOS.com

3

Interior features

**3-6. Other interior features**  
**Vanity mirror\***

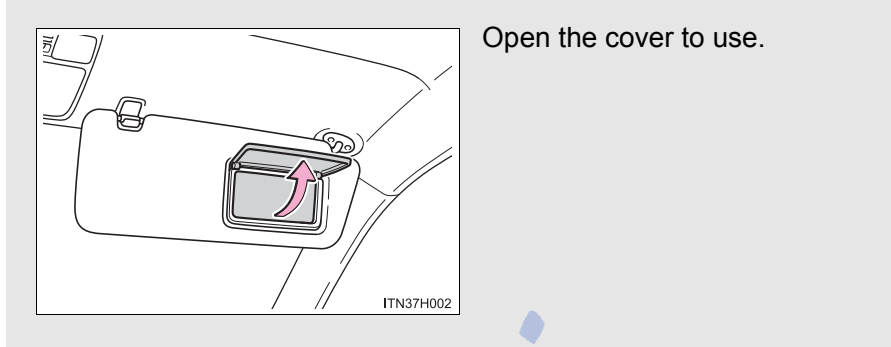

امداد خودرو فارما

تلفن شبانه روزی: ۰۲۱-۸۸۸۶۲۰۸۵

FarmaSOS.com

\*: If equipped

### 3-6. Other interior features

## Clock

#### Vehicles without multi-information display

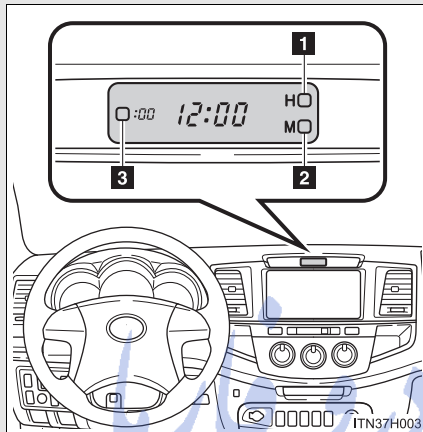

- 1 Adjusts the hours
- 2 Adjusts the minutes
- 3 Rounds to the nearest hour\*

\*: e.g. 1:00 to 1:29 → 1:00  
1:30 to 1:59 → 2:00

#### Vehicles with multi-information display

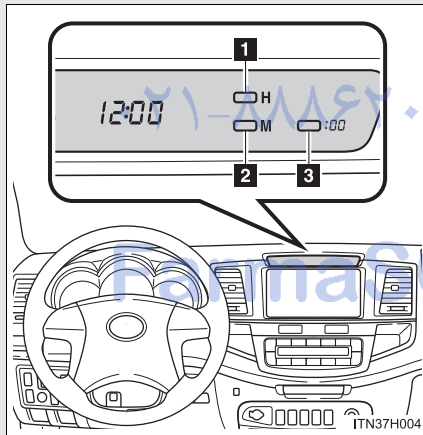

- 1 Adjusts the hours
- 2 Adjusts the minutes
- 3 Rounds to the nearest hour\*

\*: e.g. 1:00 to 1:29 → 1:00  
1:30 to 1:59 → 2:00

#### ■ The clock is displayed when

The engine switch is in the “ACC” or “ON” position.

#### ■ When disconnecting and reconnecting battery terminals

The time display will automatically be set to 1:00.

### 3-6. Other interior features

## Ashtray

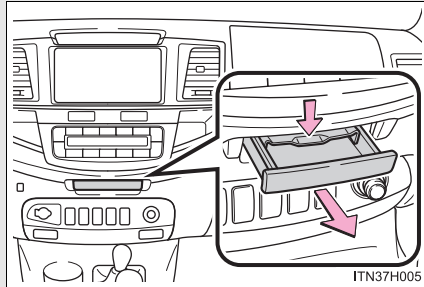

Pull the lid.

To remove the ashtray, press down on the lock spring plate and pull the lid.

#### CAUTION

##### ■ When not in use

Keep the ashtray closed. In the event of sudden braking or sudden swerving, an accident may occur due to an occupant being struck by the open ashtray or ash flying out.

##### ■ To prevent fire

- Fully extinguish matches and cigarettes before putting them in the ashtray, then make sure the ashtray is fully closed.
- Do not place paper or any other type of flammable object in the ashtray.

FarmaSOS.com

### 3-6. Other interior features

## Cigarette lighter

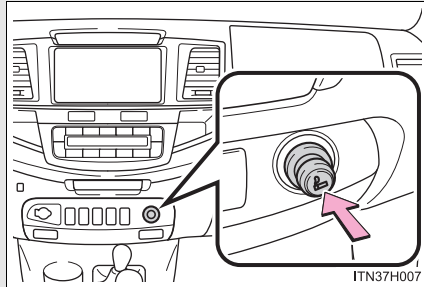

Push the cigarette lighter.

The cigarette lighter will pop up when it is ready for use.

- **The cigarette lighter can be used when**  
The engine switch is in the "ACC" or "ON" position.

#### CAUTION

##### ■ To avoid burns or fires

- Do not touch the metal part of the cigarette lighter.
- Do not hold the cigarette lighter down. It could overheat and cause a fire.
- Do not insert anything other than the cigarette lighter provided into the cigarette lighter outlet. Doing so may deform the outlet and make the cigarette lighter pop out of the outlet or become difficult to take out.

### 3-6. Other interior features

## Power outlet\*

The power outlet can be used for 12V accessories that run on less than 10A.

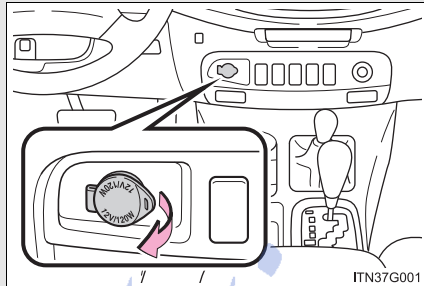

Open the cover.

- **The power outlet can be used when**  
The engine switch is in the "ACC" or "ON" position.

 **NOTICE** تلفن شبانه روزی: ۰۸۵+۸۸۶۲-۲۱

- **To avoid damaging the power outlet**  
Close the power outlet lid when the power outlet is not in use.  
Foreign objects or liquids that enter the power outlet may cause a short circuit.
- **To prevent blown fuse**  
Do not use an accessory that uses more than 12V 10A.
- **To prevent battery discharge**  
Do not use the power outlet longer than necessary when the engine is not running.

\*: If equipped

### 3-6. Other interior features

## Seat heaters\*

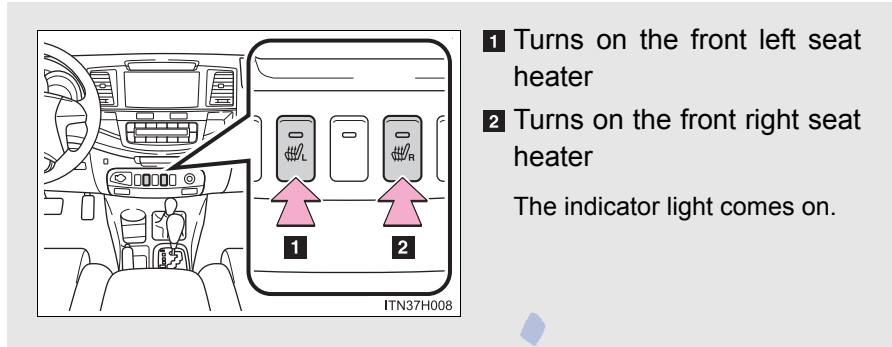

- **The seat heaters can be used when**  
The engine switch is in the "ON" position.
- **When not in use**  
Turn the seat heater off.

3

Interior features

تلفن شبانه روزی: ۰۲۱-۸۸۶۲۰۸۵

FarmaSOS.com

\*: If equipped

 CAUTION

■ Burns

- Use caution when seating the following persons in a seat with the seat heater on to avoid the possibility of burns:
  - Babies, small children, the elderly, the sick and the physically challenged
  - Persons with sensitive skin
  - Persons who are fatigued
  - Persons who have taken alcohol or drugs that induce sleep (sleeping drugs, cold remedies, etc.)
- Do not cover the seat with anything when using the seat heater. Using the seat heater with a blanket or cushion increases the temperature of the seat and may lead to overheating.
- Do not use the seat heater more than necessary. Doing so may cause minor burns or overheating.

 NOTICE

■ To prevent seat heater damage

Do not put heavy objects that have an uneven surface on the seat and do not stick sharp objects (needles, nails, etc.) into the seat.

■ To prevent battery discharge

Turn the seat heaters off when the engine is not running.



### 3-6. Other interior features

## Floor mat

Use only floor mats designed specifically for vehicles of the same model and model year as your vehicle. Fix them securely in place onto the carpet.

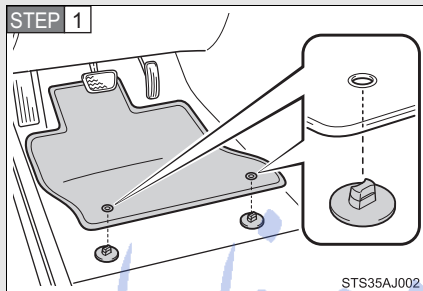

Insert the retaining hooks (clips) into the floor mat eyelets.

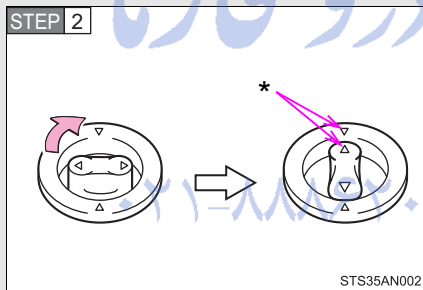

Turn the upper knob of each retaining hook (clip) to secure the floor mats in place.

\*: Always align the  $\triangle$  marks.

The shape of the retaining hooks (clips) may differ from that shown in the illustration.

**⚠ CAUTION**

Observe the following precautions.

Failure to do so may cause the driver's floor mat to slip, possibly interfering with the pedals while driving. An unexpectedly high speed may result or it may become difficult to stop the vehicle, leading to a serious accident.

■ **When installing the driver's floor mat**

- Do not use floor mats designed for other models or different model year vehicles, even if they are Toyota Genuine floor mats.
- Only use floor mats designed for the driver's seat.
- Always install the floor mat securely using the retaining hooks (clips) provided.
- Do not use two or more floor mats on top of each other.
- Do not place the floor mat bottom-side up or upside-down.

■ **Before driving**

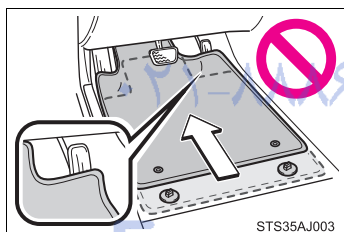

- Check that the floor mat is securely fixed in the correct place with all the provided retaining hooks (clips). Be especially careful to perform this check after cleaning the floor.
- With the engine stopped and the shift lever in P (automatic transmission) or N (manual transmission), fully depress each pedal to the floor to make sure it does not interfere with the floor mat.

### 3-6. Other interior features

## Compass\*

The compass on the multi-information display indicates the direction in which the vehicle is heading.

#### ■ Operation

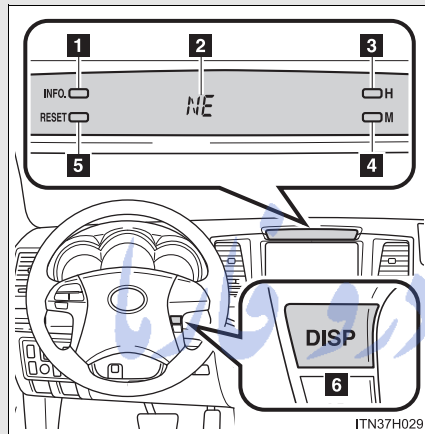

To turn the compass on, press the “INFO.” or “DISP” button until the compass appears. (→P. 185)

- 1 “INFO.” button
- 2 Direction display
- 3 “H” button
- 4 “M” button
- 5 “RESET” button
- 6 “DISP” button (if equipped)

#### ■ Displays and directions

Display	Direction
N	North
NE	Northeast
E	East
SE	Southeast
S	South
SW	Southwest
W	West
NW	Northwest

\*: If equipped

### Calibrating the compass

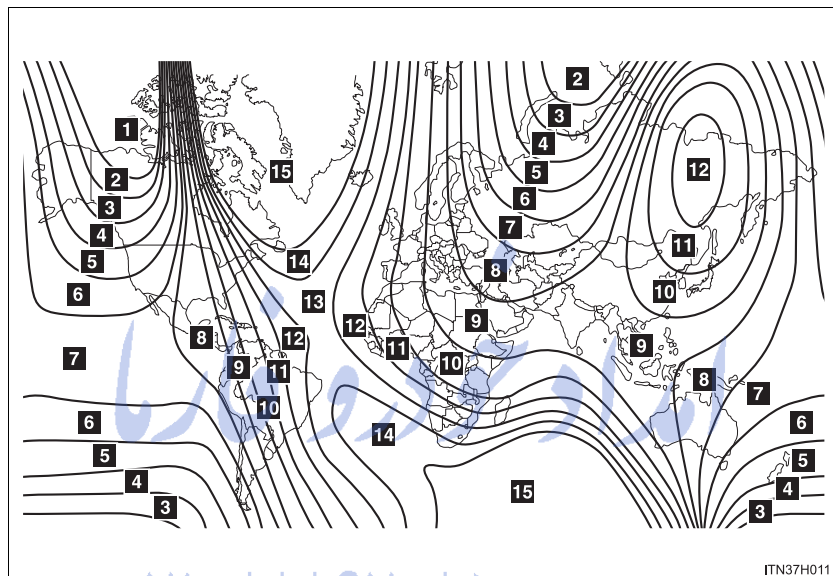

The direction display deviates from the true direction determined by the earth's magnetic field. The amount of deviation varies depending on the geographic position of the vehicle.

If you cross over one of the map boundaries shown in illustration, the compass will deviate.  
To obtain higher precision or perfect calibration, refer to "Deviation calibration".

### ■ Deviation calibration

**STEP 1** Stop the vehicle.

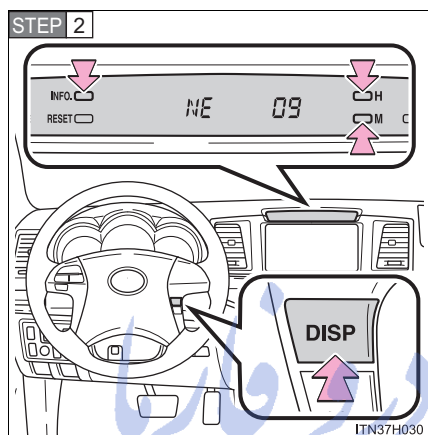

Press and hold the “INFO.” or “DISP” button until a number (1 to 15) appears on the clock. Then press the “H” or “M” button, and referring to the map above, select the number of the zone where you are.

**STEP 3** Press the “INFO.” or “DISP” button.

If the direction is displayed for several seconds after adjustment, the calibration is complete.

تلفن شبانه روزی: ۰۲۱-۸۸۶۲۰۸۵

FarmaSOS.com

### ■ Circling calibration

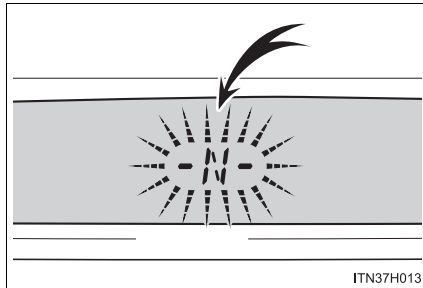

If the direction display on the compass flashes, circling calibration needs to be performed.

**STEP 1** Stop the vehicle in a place where it is safe to drive in a circle.

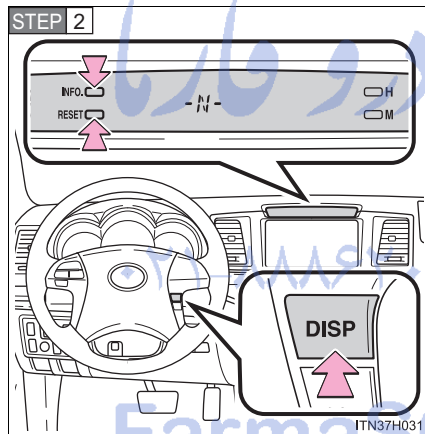

Press and hold the "INFO." or "DISP" button until a number (1 to 15) appears on the clock, and press the "RESET" button.

"- N -" appears on the direction display.

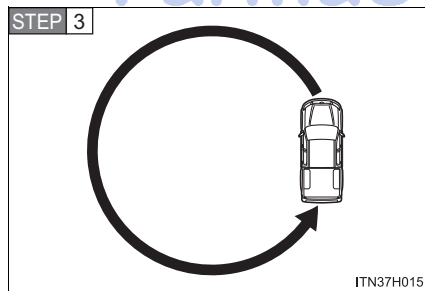

Drive the vehicle at 8 km/h (5 mph) or less in a circle until a direction is displayed.

If there is not enough space to drive in a circle, drive around the block until a direction is displayed.

■ **Conditions unfavorable to correct operation**

The compass may not show the correct direction in the following conditions:

- The vehicle is stopped immediately after turning.
- The vehicle is on an inclined surface.
- The vehicle is in a place where the earth's magnetic field is subject to interference by artificial magnetic fields (underground car park/parking lot, under a steel tower, between buildings, roof car park/parking lot, near an intersection, near a large vehicle, etc.).
- The vehicle has become magnetized.  
(There is a magnet or metal object near the multi-information display.)
- The battery has been disconnected.
- A door is open.

تلفن شبانه روزی: ۰۲۱-۸۸۶۲۰۸۵

FarmaSOS.com

 CAUTION

■ **While driving the vehicle**

Do not adjust the display. Adjust the display only when the vehicle is stopped.

■ **When doing the circling calibration**

Secure a wide space, and watch out for people and vehicles in the vicinity. Do not violate any local traffic rules while performing circling calibration.

 NOTICE

■ **To avoid compass malfunctions**

Do not place magnets or any metal objects near the multi-information display. Doing this may cause the compass sensor to malfunction.

■ **To ensure normal operation of the compass**

- Do not perform a circling calibration of the compass in a place where the earth's magnetic field is subject to interference by artificial magnetic fields.
- During calibration, do not operate electric systems (power windows etc.) as they may interfere with the calibration.

FarmaSOS.com



### 3-6. Other interior features

## Deck hooks\*

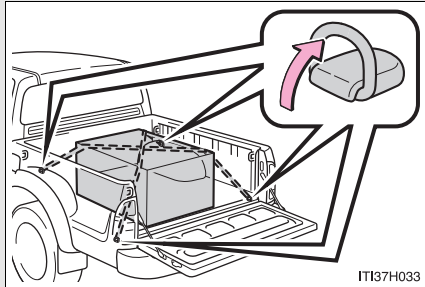

Raise the hooks when needed.

The deck hooks are provided for securing loose items.

#### CAUTION

■ **When the deck hooks are not in use**

To avoid injury, always return the deck hooks to their stowed positions.

3

Interior features

تلفن شبانه روزی: ۰۲۱-۸۸۶۲۰۸۵

FarmaSOS.com

\*: If equipped

465

امداد خودرو فارما

تلفن شبانه روزی: ۰۲۱-۸۸۸۶۲۰۸۵

[FarmaSOS.com](http://FarmaSOS.com)

## Maintenance and care

# 4

### 4-1. Maintenance and care

- Cleaning and protecting the vehicle exterior ..... 466
- Cleaning and protecting the vehicle interior ..... 470

### 4-2. Maintenance

- Maintenance requirements..... 474

### 4-3. Do-it-yourself maintenance

- Do-it-yourself service precautions ..... 478
- Hood ..... 482
- Engine compartment..... 484
- Tires ..... 501
- Tire inflation pressure ..... 505
- Wheels..... 507
- Air conditioning filter ..... 509
- Wireless remote control battery..... 511
- Checking and replacing fuses ..... 514
- Light bulbs ..... 530

## 4-1. Maintenance and care

### Cleaning and protecting the vehicle exterior

**Perform the following to protect the vehicle and maintain it in prime condition:**

- Working from top to bottom, liberally apply water to the vehicle body, wheel wells and underside of the vehicle to remove any dirt and dust.
- Wash the vehicle body using a sponge or soft cloth, such as a chamois.
- For hard-to-remove marks, use car wash soap and rinse thoroughly with water.
- Wipe away any water.
- Wax the vehicle when the waterproof coating deteriorates.

If water does not bead on a clean surface, apply wax when the vehicle body is cool.

---

#### ■ Automatic car washes

- Fold the mirrors and remove (vehicles with short pole type antenna) or retract (vehicles with pillar type antenna) the antenna before washing the vehicle. Start washing from the front of the vehicle. Make sure to re-install the antenna (vehicles with short pole type antenna) and extend the mirrors before driving.
- Brushes used in automatic car washes may scratch the vehicle surface and harm your vehicle's paint.

#### ■ High pressure car washes

- Do not allow the nozzles of the car wash to come within close proximity of the windows.
- Before using the car wash, check that the fuel filler door on your vehicle is closed properly.

#### ■ Aluminum wheels (if equipped)

- Remove any dirt immediately by using a neutral detergent. Do not use hard brushes or abrasive cleaners. Do not use strong or harsh chemical cleaners.  
Use the same mild detergent and wax as used on the paint.
- Do not use detergent on the wheels when they are hot, for example after driving for long distance in the hot weather.
- Wash detergent from the wheels immediately after use.

#### ■ Bumpers

Do not scrub with abrasive cleaners.

#### ⚠ CAUTION

##### ■ When washing the vehicle

Do not apply water to the inside of the engine compartment. Doing so may cause the electrical components etc. to catch fire.

##### ■ Precautions regarding the exhaust pipe

Exhaust gasses cause the exhaust pipe to become quite hot.

When washing the vehicle, be careful not to touch the pipe until it has cooled sufficiently, as touching a hot exhaust pipe can cause burns.

 NOTICE

■ **To prevent paint deterioration and corrosion on the body and components (aluminum wheels etc.)**

- Wash the vehicle immediately in the following cases:
  - After driving near the sea coast
  - After driving on salted roads
  - If coal tar or tree sap is present on the paint surface
  - If dead insects, insect droppings or bird droppings are present on the paint surface
  - After driving in an area contaminated with soot, oily smoke, mine dust, iron powder or chemical substances
  - If the vehicle becomes heavily soiled with dust or mud
  - If liquids such as benzene and gasoline are spilled on the paint surface
- If the paint is chipped or scratched, have it repaired immediately.
- To prevent the wheels from corroding, remove any dirt and store in a place with low humidity when storing the wheels.

■ **Cleaning the exterior lights**

- Wash carefully. Do not use organic substances or scrub with a hard brush. This may damage the surfaces of the lights.
- Do not apply wax to the surfaces of the lights. Wax may cause damage to the lenses.

 NOTICE

■ **Antenna installation and removal precautions (vehicles with short pole type antenna)**

- Before driving, ensure that the antenna is installed.
- When the antenna is removed, such as before entering an automatic car wash, make sure to store it in a suitable place so as not to lose it. Also, before driving, make sure to reinstall the antenna in its original position.

امداد خودرو فارما

تلفن شبانه روزی: ۰۲۱-۸۸۸۶۲۰۸۵

FarmaSOS.com

## 4-1. Maintenance and care

### Cleaning and protecting the vehicle interior

The following procedures will help protect your vehicle's interior and keep it in top condition:

#### ■ Protecting the vehicle interior

Remove dirt and dust using a vacuum cleaner. Wipe dirty surfaces with a cloth dampened with lukewarm water.

#### ■ Cleaning the leather areas

- Remove dirt and dust using a vacuum cleaner.
- Wipe off any excess dirt and dust with a soft cloth dampened with diluted detergent.

Use a diluted water solution of approximately 5% neutral wool detergent.

- Wring out any excess water from the cloth and thoroughly wipe off all remaining traces of detergent.
- Wipe the surface with a dry, soft cloth to remove any remaining moisture. Allow the leather to dry in a shaded and ventilated area.

#### ■ Cleaning the synthetic leather areas

- Remove loose dirt using a vacuum cleaner.
- Apply a mild soap solution to the synthetic leather using a sponge or soft cloth.
- Allow the solution to soak in for a few minutes. Remove the dirt and wipe off the solution with a clean, damp cloth.



#### ■ Caring for leather areas

Toyota recommends cleaning the interior of the vehicle at least twice a year to maintain the quality of the vehicle's interior.

#### ■ Shampooing the carpets

There are several commercial foaming-type cleaners available. Use a sponge or brush to apply the foam. Rub in overlapping circles. Do not use water. Wipe dirty surfaces and let them dry. Excellent results are obtained by keeping the carpet as dry as possible.

#### ■ Seat belts

Clean with mild soap and lukewarm water using a cloth or sponge. Also check the belts periodically for excessive wear, fraying or cuts.

#### ⚠ CAUTION

#### ■ Water in the vehicle

- Do not splash or spill liquid in the vehicle.  
Doing so may cause electrical components etc. to malfunction or catch fire.
- Do not get any of the SRS components or wiring in the vehicle interior wet.  
(→P. 110)  
An electrical malfunction may cause the airbags to deploy or not function properly, resulting in death or serious injury.

#### ■ Cleaning the interior (especially instrument panel)

Do not use polish wax or polish cleaner. The instrument panel may reflect off the windshield, obstructing the driver's view and leading to an accident, resulting in death or serious injury.

 NOTICE

■ **Cleaning detergents**

- Do not use the following types of detergent, as they may discolor the vehicle interior or cause streaks or damage to painted surfaces:
  - Non-seat portions: Organic substances such as benzene or gasoline, alkaline or acidic solutions, dye, and bleach
  - Seats: Alkaline or acidic solutions, such as thinner, benzene, and alcohol
- Do not use polish wax or polish cleaner. The instrument panel's or other interior part's painted surface may be damaged.

■ **Preventing damage to leather surfaces**

Observe the following precautions to avoid damage to and deterioration of leather surfaces:

- Remove any dust or dirt from leather surfaces immediately.
- Do not expose the vehicle to direct sunlight for extended periods of time. Park the vehicle in the shade, especially during summer.
- Do not place items made of vinyl, plastic, or containing wax on the upholstery, as they may stick to the leather surface if the vehicle interior heats up significantly.

■ **Water on the floor**

Do not wash the vehicle floor with water.

Vehicle systems such as the audio system may be damaged if water comes into contact with electrical components such as the audio system above or under the floor of the vehicle. Water may also cause the body to rust.

 NOTICE

■ **Cleaning the inside of the rear window (vehicles with rear window defogger)**

- Do not use glass cleaner to clean the rear window, as this may cause damage to the rear window defogger heater wires. Use a cloth dampened with lukewarm water to gently wipe the window clean. Wipe the window in strokes running parallel to the heater wires.
- Be careful not to scratch or damage the heater wires.

امداد خودرو فارما

تلفن شبانه روزی: ۰۲۱-۸۸۸۶۲۰۸۵

FarmaSOS.com

## 4-2. Maintenance

### Maintenance requirements

To ensure safe and economical driving, day-to-day care and regular maintenance are essential. Toyota recommends performing the following maintenance:

#### ■ Scheduled maintenance

Scheduled maintenance should be performed at specified intervals according to the maintenance schedule.

For full details of your maintenance schedule, refer to the “Toyota Service Booklet” or “Toyota Warranty Booklet”.

#### ■ Do-it-yourself maintenance

What about do-it-yourself maintenance?

Many maintenance items are easy to do yourself if you have a little mechanical ability and a few basic automotive tools.

Note, however, that some maintenance tasks require special tools and skills. These are best performed by qualified technicians. Even if you're an experienced do-it-yourself mechanic, we recommend that repairs and maintenance be conducted by any authorized Toyota dealer or repairer, or another duly qualified and equipped professional. Any authorized Toyota dealer or repairer will keep a record of maintenance, which could be useful should you ever require Warranty Service. Should you choose to select a qualified and equipped professional other than an authorized Toyota repairer to service or maintain your vehicle, we recommend that you request that a record of maintenance be kept.

**■ Where to go for service?**

In order to maintain your vehicle in the best possible condition, Toyota recommends that all repairs and service operations be carried out by authorized Toyota dealers or repairers or other duly qualified and equipped professionals. For repairs and services covered by your warranty, please visit an authorized Toyota dealer or repairer, who will use genuine Toyota parts in repairing any difficulties you may encounter. There can also be advantages in utilizing authorized Toyota dealers or repairers for non-warranty repairs and services, as members of the Toyota network will be able to expertly assist you with any difficulties you may encounter.

Your Toyota dealer or repairer, or another duly qualified and equipped professional will perform all of the scheduled maintenance on your vehicle reliably and economically due to their experience with Toyota vehicles.

تلفن شبانه روزی: ۰۲۱-۸۸۸۶۲۰۸۵

FarmaSOS.com

■ **Does your vehicle need repairs?**

Be on the alert for changes in performance and sounds, and visual tip-offs that indicate service is needed. Some important clues are:

- Engine missing, stumbling or pinging
- Appreciable loss of power
- Strange engine noises
- A fluid leak under the vehicle (However, water dripping from the air conditioning system after use is normal.)
- Change in exhaust sound (This may indicate a dangerous carbon monoxide leak. Drive with the windows open and have the exhaust system checked immediately.)
- Flat-looking tires, excessive tire squeal when cornering, uneven tire wear
- Vehicle pulls to one side when driven straight on a level road
- Strange noises related to suspension movement
- Loss of brake effectiveness, spongy feeling brake pedal or clutch pedal, pedal almost touches the floor, vehicle pulls to one side when braking
- Engine coolant temperature continually higher than normal

If you notice any of these clues, take your vehicle to any authorized Toyota dealer or repairer, or another duly qualified and equipped professional as soon as possible. Your vehicle may need adjustment or repair.

FarmaSOS.com

**⚠ CAUTION****■ If your vehicle is not properly maintained**

Improper maintenance could result in serious damage to the vehicle and possible serious injury or death.

**■ Handling of the battery**

Battery posts, terminals and related accessories contain lead and lead compounds which are known to cause brain damage. Wash your hands after handling. (→P. 496)

امداد خودرو فارما

تلفن شبانه روزی: ۰۲۱-۸۸۸۶۲۰۸۵

FarmaSOS.com

### 4-3. Do-it-yourself maintenance

## Do-it-yourself service precautions

If you perform maintenance by yourself, be sure to follow the correct procedure as given in these sections.

Items	Parts and tools
Battery condition (→P. 496)	<ul style="list-style-type: none"><li>• Warm water</li><li>• Baking soda</li><li>• Grease</li><li>• Conventional wrench (for terminal clamp bolts)</li><li>• Distilled water</li></ul>
Engine coolant level (→P. 493)	<ul style="list-style-type: none"><li>• "Toyota Super Long Life Coolant" or a similar high quality ethylene glycol-based non-silicate, non-amine, non-nitrite and non-borate coolant with long-life hybrid organic acid technology</li><li>• "Toyota Super Long Life Coolant" is pre-mixed with 50% coolant and 50% deionized water.</li><li>• Funnel (used only for adding coolant)</li></ul>
Engine oil level (→P. 488)	<ul style="list-style-type: none"><li>• "Toyota Genuine Motor Oil" or equivalent</li><li>• Rag or paper towel</li><li>• Funnel (used only for adding engine oil)</li></ul>



Items	Parts and tools
Fuses (→P. 516)	• Fuse with same amperage rating as original
Light bulbs (→P. 532)	• Bulb with same number and wattage rating as original • Phillips-head screwdriver • Wrench
Radiator, condenser and intercooler (→P. 495)	—
Tire inflation pressure (→P. 507)	• Tire pressure gauge • Compressed air source
Washer fluid (→P. 500)	• Water or washer fluid containing antifreeze (for winter use) • Funnel (used only for adding water or washer fluid)

تلفن شبانه روزی: ۰۲۱-۸۸۶۲۰۸۵

FarmaSOS.com

 CAUTION

The engine compartment contains many mechanisms and fluids that may move suddenly, become hot, or become electrically energized. To avoid death or serious injury, observe the following precautions.

■ **When working on the engine compartment**

- Keep hands, clothing and tools away from the moving fan and engine drive belt.
- Be careful not to touch the engine, radiator, exhaust manifold, etc. right after driving as they may be hot. Oil and other fluids may also be hot.
- Do not leave anything that may burn easily, such as paper and rags, in the engine compartment.
- Do not smoke, cause sparks or expose an open flame to fuel or the battery. Fuel and battery fumes are flammable.
- Be extremely cautious when working on the battery. It contains poisonous and corrosive sulfuric acid.
- Take care because brake fluid can harm your hands or eyes and damage painted surfaces. If fluid gets on your hands or in your eyes, flush the affected area with clean water immediately. If you still experience discomfort, consult a doctor.

■ **Safety glasses**

Wear safety glasses to prevent flying or falling material, fluid spray, etc. from getting in your eyes.

 NOTICE

■ **If you remove the air cleaner filter**

Driving with the air cleaner filter removed may cause excessive engine wear due to dirt in the air.

■ **If the fluid level is low or high**

It is normal for the brake fluid level to go down slightly as the brake pads wear or when the fluid level in the accumulator is high.

If the reservoir needs frequent refilling, it may indicate a serious problem.

امداد خودرو فارما

تلفن شبانه روزی: ۰۲۱-۸۸۸۶۲۰۸۵

FarmaSOS.com

### 4-3. Do-it-yourself maintenance

## Hood

Release the lock from the inside of the vehicle to open the hood.

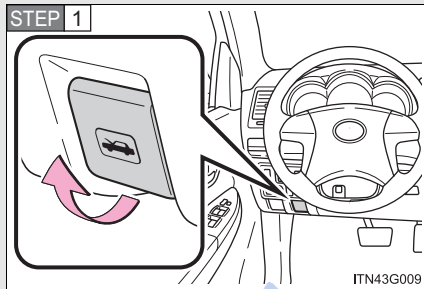

Pull the hood lock release lever.

The hood will pop up slightly.

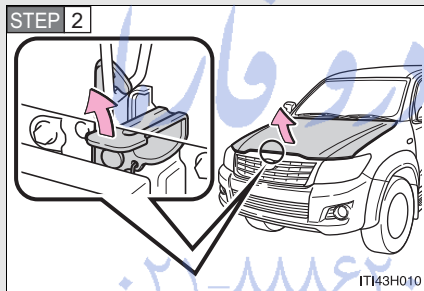

Pull up the auxiliary catch lever and lift the hood.

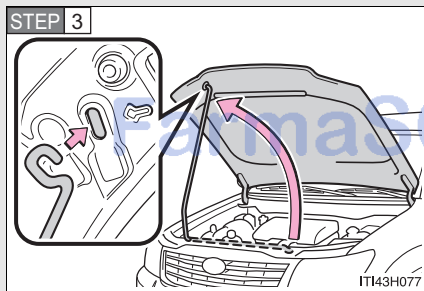

Hold the hood open by inserting the supporting rod into the slot.

 CAUTION

■ **Pre-driving check**

Check that the hood is fully closed and locked.  
If the hood is not locked properly, it may open while the vehicle is in motion and cause an accident, which may result in death or serious injury.

■ **After installing the support rod into the slot**

Make sure the rod supports the hood securely from falling down on to your head or body.

 NOTICE

■ **When closing the hood**

Be sure to return the support rod to its clip before closing the hood. Closing the hood with the support rod up could cause the hood to bend.

## 4-3. Do-it-yourself maintenance Engine compartment

### Left-hand drive vehicles

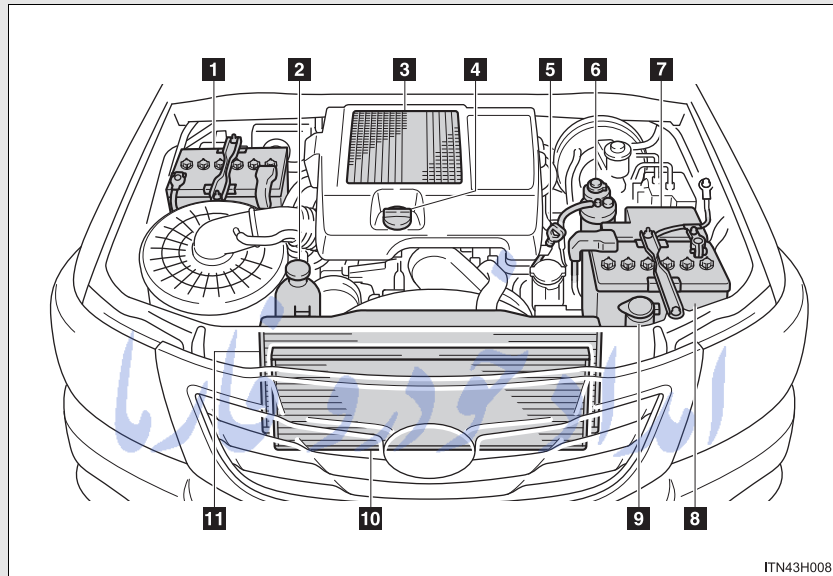

- |  |   |
|--|---|
| <b>1</b> Battery (if equipped)<br>(→P. 496)    | <b>5</b> Engine oil level dipstick<br>(→P. 488) |
| <b>2</b> Engine coolant reservoir<br>(→P. 493) | <b>6</b> Fuel filter (→P. 502, 595)             |
| <b>3</b> Intercooler (→P. 495)                 | <b>7</b> Fuse box (→P. 516)                     |
| <b>4</b> Engine oil filler cap<br>(→P. 490)    | <b>8</b> Battery (→P. 496)                      |
|  | <b>9</b> Washer fluid tank (→P. 500)            |
|  | <b>10</b> Condenser (→P. 495)                   |
|  | <b>11</b> Radiator (→P. 495)                    |

**Right-hand drive vehicles**

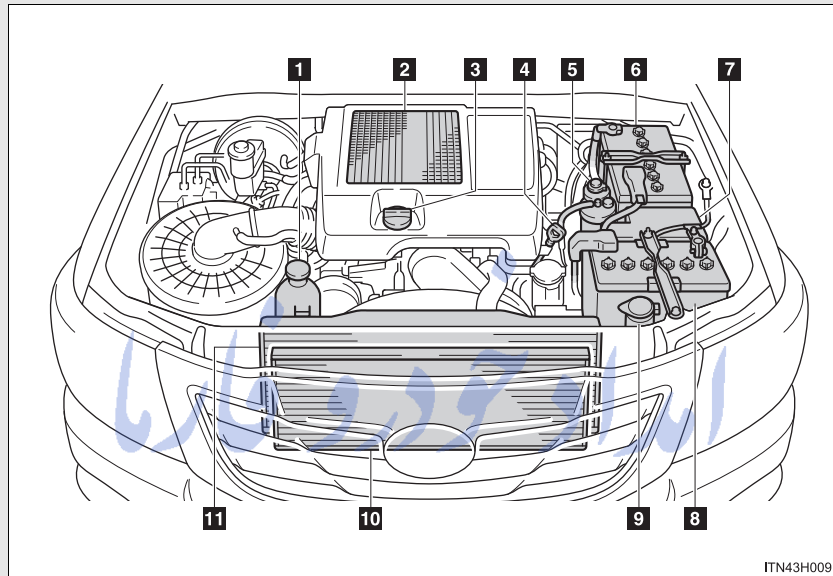

- |   |   |
|---|---|
| <b>1</b> Engine coolant reservoir<br>(→P. 493)  | <b>6</b> Battery (if equipped)<br>(→P. 496) |
| <b>2</b> Intercooler<br>(→P. 495)               | <b>7</b> Fuse box<br>(→P. 516)              |
| <b>3</b> Engine oil filler cap<br>(→P. 490)     | <b>8</b> Battery<br>(→P. 496)               |
| <b>4</b> Engine oil level dipstick<br>(→P. 488) | <b>9</b> Washer fluid tank<br>(→P. 500)     |
| <b>5</b> Fuel filter<br>(→P. 502, 595)          | <b>10</b> Condenser<br>(→P. 495)            |
|   | <b>11</b> Radiator<br>(→P. 495)             |

## Engine oil

With the engine at operating temperature and turned off, check the oil level on the dipstick.

### ■ Checking the engine oil

**STEP 1** Park the vehicle on level ground. After turning off the engine, wait more than 5 minutes for the oil to drain back into the bottom of the engine.

**STEP 2** Remove the sand and dust from around the dipstick.

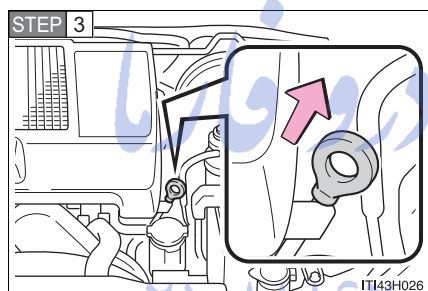

Holding a rag under the end, pull the dipstick out.

**STEP 4** Wipe the dipstick clean.

Make sure that the inlet of the oil level gauge guide and O-ring of the dipstick are free from sand and dust.

If the O-ring is damaged, replace it with a new one.

**STEP 5** Reinsert the dipstick fully.

**STEP 6** Holding a rag under the end, pull the dipstick out and check the oil level.

**STEP 7** Wipe the dipstick and reinsert it fully.



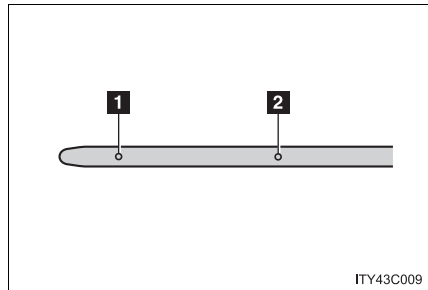

- 1** Low
- 2** Full

امداد خودرو فارما

تلفن شبانه روزی: ۰۲۱-۸۸۸۶۲۰۸۵

FarmaSOS.com

### ■ Adding engine oil

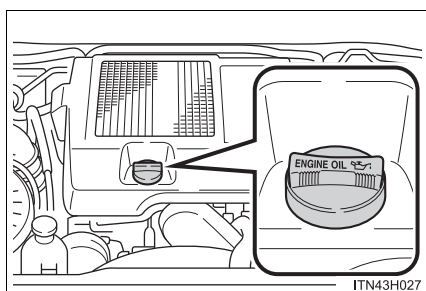

If the oil level is below or near the low level mark, add engine oil of the same type as that already in the engine.

Make sure to check the oil type and prepare the items needed before adding oil.

Engine oil selection	→P. 610, 612
Oil quantity (Low → Full)	For Russia and Ukraine 1.6 L (1.7 qt., 1.4 Imp.qt.) Except for Russia and Ukraine 1.4 L (1.5 qt., 1.2 Imp.qt.)
Items	Clean funnel

- STEP 1** Remove the sand and dust from around the oil filler cap.
- STEP 2** Remove the oil filler cap by turning it counterclockwise.
- STEP 3** Add engine oil slowly, checking the dipstick.
- STEP 4** Install the oil filler cap by turning it clockwise.

**■ Engine oil consumption**

- The amount of engine oil consumed depends on the oil viscosity, the quality of the oil and the way the vehicle is driven.
- More oil is consumed under driving conditions such as high speeds and frequent acceleration and deceleration.
- A new engine consumes more oil.
- When judging the amount of oil consumption, keep in mind that the oil may have become diluted, making it difficult to judge the true level accurately.
- Oil consumption: Max. 1.0 L/1000 km (1.1 qt./600 miles, 0.9 Imp.qt./600 miles)
- If your vehicle consumes more than 1.0 L (1.1 qt., 0.9 Imp.qt.) every 1000 km (600 miles), contact any authorized Toyota dealer or repairer, or another duly qualified and equipped professional.

**■ After changing the engine oil**

The engine oil maintenance data should be reset. Perform the following procedures:

- STEP 1** Switch the display to the trip meter A (→P. 178) when the engine is in the “ON” position.
- STEP 2** Turn the engine switch to the “LOCK” position.
- STEP 3** While pressing the odometer/trip meter display change button (→P.178), turn the engine switch to the “ON” position (do not start the engine because reset mode will be canceled). Continue to press and hold the button for more than one second after the trip meter displays “000000”.

 CAUTION

■ **Used engine oil**

- Used engine oil contains potentially harmful contaminants which may cause skin disorders such as inflammation and skin cancer, so care should be taken to avoid prolonged and repeated contact. To remove used engine oil from your skin, wash thoroughly with soap and water.
- Dispose of used oil and filters only in a safe and acceptable manner. Do not dispose of used oil and filters in household trash, in sewers or onto the ground. Call any authorized Toyota dealer or repairer, or another duly qualified and equipped professional, service station or auto parts store for information concerning recycling or disposal.
- Do not leave used engine oil within the reach of children.

 NOTICE

■ **To prevent serious engine damage**

Check the oil level on a regular basis.

■ **When replacing the engine oil**

- Be careful not to spill engine oil on the vehicle components.
- Avoid overfilling, or the engine could be damaged.
- Check the oil level on the dipstick every time you refill the vehicle.
- Be sure the engine oil filler cap is properly tightened.

## Engine coolant

The coolant level is satisfactory if it is between the upper and lower lines on the reservoir when the engine is cold.

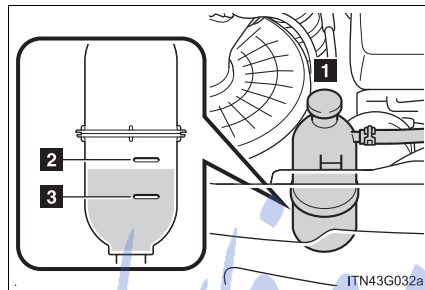

- 1 Reservoir cap
- 2 Upper line
- 3 Lower line

If the level is on or below the lower line, add coolant up to the upper line. (→P. 592)

### ■ Coolant selection

Only use "Toyota Super Long Life Coolant" or a similar high quality ethylene glycol based non-silicate, non-amine, non-nitrite, and non-borate coolant with long-life hybrid organic acid technology.

"Toyota Super Long Life Coolant" is a mixture of 50% coolant and 50% deionized water. (Minimum temperature: -35°C [-31°F])

For more details about engine coolant, contact any authorized Toyota dealer or repairer, or another duly qualified and equipped professional.

### ■ If the coolant level drops within a short time of replenishing

Visually check the radiator, hoses, engine coolant reservoir caps, drain cock and water pump.

If you cannot find a leak, have any authorized Toyota dealer or repairer, or another duly qualified and equipped professional, test the cap and check for leaks in the cooling system.

 CAUTION

■ **When the engine is hot**

Do not remove the engine coolant reservoir cap.

The cooling system may be under pressure and may spray hot coolant if the cap is removed, causing serious injuries, such as burns.

 NOTICE

■ **When adding coolant**

Coolant is neither plain water nor straight antifreeze. The correct mixture of water and antifreeze must be used to provide proper lubrication, corrosion protection and cooling. Be sure to read the antifreeze or coolant label.

■ **If you spill coolant**

Be sure to wash it off with water to prevent it from damaging parts or paint.

■ **Notice on coolant quality**

Do not use improper coolant. If improper coolant is used, the engine cooling system may be damaged.

FarmaSOS.com

### Radiator, condenser and intercooler

Check the radiator, condenser and intercooler and clear away any foreign objects.

If any of the above parts is extremely dirty or you are not sure of their condition, have your vehicle inspected by any authorized Toyota dealer or repairer, or another duly qualified and equipped professional.

#### CAUTION

##### ■ When the engine is hot







Do not touch the radiator, condenser or intercooler as they may be hot and cause serious injuries, such as burns.

### Battery

Check the battery as follows.

#### ■ Caution symbols

The meanings of each caution symbol on the top of the battery are as follows:

	No smoking, no naked flames, no sparks		Battery acid
	Shield eyes		Note operating instructions
	Keep away from children		Explosive gas

#### ■ Battery exterior

Make sure that the battery terminals are not corroded and that there are no loose connections, cracks, or loose clamps.

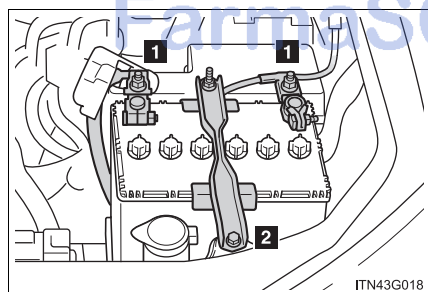

- 1 Terminals
- 2 Hold-down clamp



■ **Checking battery fluid**

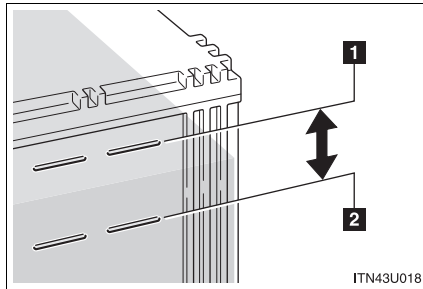

Check that the level is between the upper and lower lines.

- 1 Upper line
- 2 Lower line

If the fluid level is at or below the lower line, add distilled water.

■ **Adding distilled water**

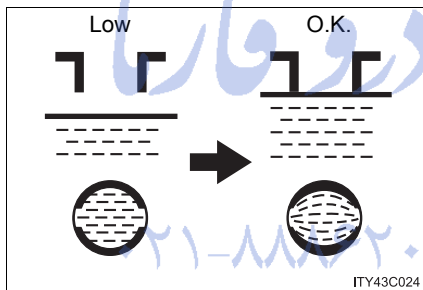

**STEP 1** Remove the vent plug.

**STEP 2** Add distilled water.

If the upper line cannot be seen, check the fluid level by looking directly at the cell.

**STEP 3** Put the vent plug back on and close it securely.

■ **Before recharging**

When recharging, the battery produces hydrogen gas which is flammable and explosive. Therefore, observe the following before recharging:

- If recharging with the battery installed on the vehicle, be sure to disconnect the ground cable.
- Make sure the power switch on the charger is off when connecting and disconnecting the charger cables to the battery.

 **CAUTION**

■ **Chemicals in the battery**

Batteries contain poisonous and corrosive sulfuric acid and may produce hydrogen gas which is flammable and explosive. To reduce the risk of death or serious injury, take the following precautions while working on or near the battery:

- Do not cause sparks by touching the battery terminals with tools.
- Do not smoke or light a match near the battery.
- Avoid contact with eyes, skin and clothes. تلفن شبانه روزی:
- Never inhale or swallow electrolyte.
- Wear protective safety glasses when working near the battery.
- Keep children away from the battery.

■ **Where to safely charge the battery**

Always charge the battery in an open area. Do not charge the battery in a garage or closed room where there is insufficient ventilation.

**⚠ CAUTION****■ Emergency measures regarding electrolyte**

- If electrolyte gets in your eyes  
Flush your eyes with clean water for at least 15 minutes and get immediate medical attention. If possible, continue to apply water with a sponge or cloth while traveling to the nearest medical facility.
- If electrolyte gets on your skin  
Wash the affected area thoroughly. If you feel pain or burning, get medical attention immediately.
- If electrolyte gets on your clothes  
It can soak through clothing on to your skin. Immediately take off the clothing and follow the procedure above if necessary.
- If you accidentally swallow electrolyte  
Drink a large quantity of water or milk. Follow with milk of magnesia, beaten raw egg or vegetable oil. Get emergency medical attention immediately.

**⚠ NOTICE****■ When recharging the battery**

Never recharge the battery while the engine is running. Also, be sure all accessories are turned off.

**■ When adding distilled water**

Avoid overfilling. Water spilled during battery recharging may cause corrosion.

### Washer fluid

#### Vehicles without washer fluid level gauge

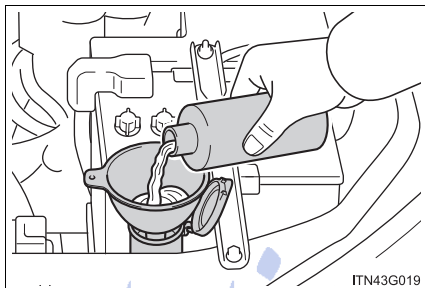

If any washer does not work, the washer tank may be empty. Add washer fluid.

#### Vehicles with washer fluid level gauge

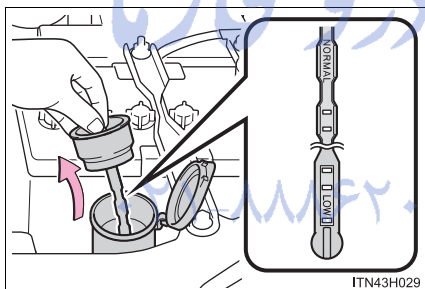

If the washer fluid level is at "LOW", add washer fluid.

FarmaSOS.com

### ■ Using the gauge (if equipped)

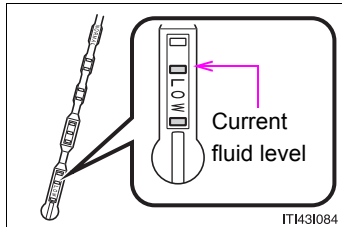

The washer fluid level can be checked by observing the position of the level on the liquid-covered holes in the gauge.

If the level falls below the second hole from the bottom (the “LOW” position), refill the washer fluid.

### ⚠ CAUTION

#### ■ When adding washer fluid

Do not add washer fluid when the engine is hot or running as washer fluid contains alcohol and may catch fire if spilled on the engine etc.

### ⚠ NOTICE

#### ■ Do not use any fluid other than washer fluid

Do not use soapy water or engine antifreeze instead of washer fluid. Doing so may cause streaking on the vehicle's painted surfaces.

#### ■ Diluting washer fluid

Dilute washer fluid with water as necessary. Refer to the freezing temperatures listed on the label of the washer fluid bottle.

### Fuel filter

You may drain the fuel filter yourself. However, as the operation is difficult, we recommend having it drained by any authorized Toyota dealer or repairer, or another duly qualified and equipped professional. Even if you decide to drain it yourself, contact any authorized Toyota dealer or repairer, or another duly qualified and equipped professional.

The water in the fuel filter needs to be drained if the fuel system warning light flashes. (→P. 560)

**STEP 1** Turn the engine switch to the “LOCK” position.

**STEP 2** Place a small tray under the drain plug or drain hose to catch the water and any fuel that comes out.

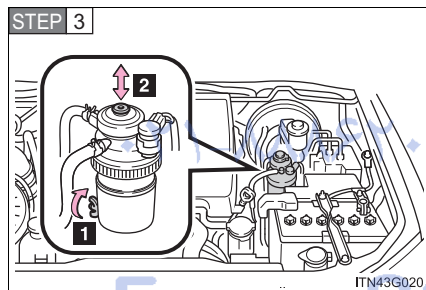

**1** Turn the drain plug counter-clockwise about 2 to 2 1/2 turns.

**2** Operate the priming pump until fuel begins to run out.

**STEP 4** After draining, tighten the drain plug by hand.

## 4-3. Do-it-yourself maintenance

### Tires

Replace or rotate tires in accordance with maintenance schedules and treadwear.

#### ■ Checking tires

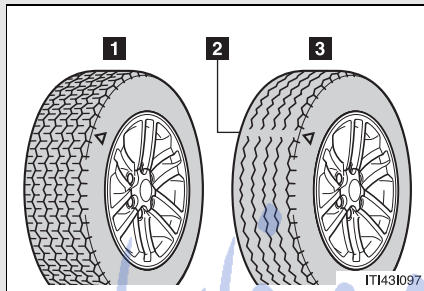

- 1 New tread
- 2 Treadwear indicator
- 3 Worn tread

The location of treadwear indicators is shown by the “TWI” or “Δ” marks, etc., molded on the sidewall of each tire.

Check spare tire condition and pressure if not rotated.

#### ■ Tire rotation

Vehicles with spare tire of a different wheel type from the installed tires

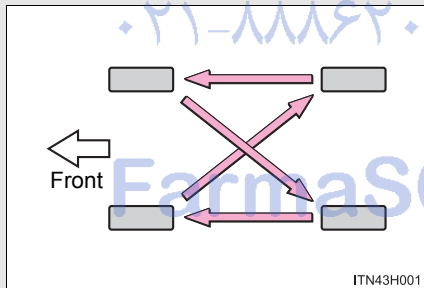

Rotate the tires in the order shown.

To equalize tire wear and help extend tire life, Toyota recommends that tire rotation is carried out approximately every 10000 km (6000 miles).

**Vehicles with spare tire of the same wheel type as the installed tires**

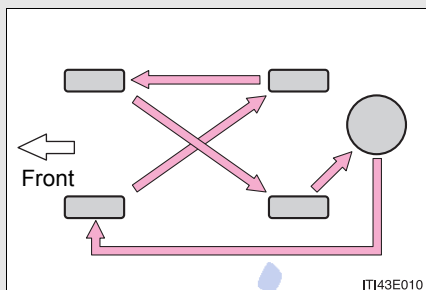

Rotate the tires in the order shown.

To equalize tire wear and help extend tire life, Toyota recommends that tire rotation is carried out approximately every 10000 km (6000 miles).

■ **When to replace your vehicle's tires**

Tires should be replaced if:

- You have tire damage such as cuts, splits, cracks deep enough to expose the fabric, and bulges indicating internal damage
- A tire goes flat repeatedly or cannot be properly repaired due to the size or location of a cut or other damage

If you are not sure, consult with any authorized Toyota dealer or repairer, or another duly qualified and equipped professional.



■ **Tire life**

Any tire over 6 years old must be checked by a qualified technician even if it has seldom or never been used or damage is not obvious.

■ **If the tread on snow tires wears down below 4 mm (0.16 in.)**

The effectiveness of the tires as snow tires is lost.

 **CAUTION**

■ **When inspecting or replacing tires**

Observe the following precautions to prevent accidents. Failure to do so may cause damage to parts of the drive train as well as dangerous handling characteristics, which may lead to an accident resulting in death or serious injury.

- Do not mix tires of different makes, models or tread patterns.  
Also, do not mix tires of remarkably different treadwear.
- Do not use tire sizes other than those recommended by Toyota.
- Do not mix differently constructed tires (radial, bias-belted or bias-ply tires).
- Do not mix summer, all season and snow tires.
- Do not use tires that have been used on another vehicle.  
Do not use tires if you do not know how they were used previously.

 NOTICE

■ **Driving on rough roads**

Take particular care when driving on roads with loose surfaces or potholes. These conditions may cause losses in tire inflation pressure, reducing the cushioning ability of the tires. In addition, driving on rough roads may cause damage to the tires themselves, as well as the vehicle's wheels and body.

■ **If tire inflation pressure of each tire becomes low while driving**

Do not continue driving, or your tires and/or wheels may be ruined.

امداد خودرو فارما

تلفن شبانه روزی: ۰۲۱-۸۸۸۶۲۰۸۵

FarmaSOS.com

### 4-3. Do-it-yourself maintenance

## Tire inflation pressure

**Make sure to maintain proper tire inflation pressure. Tire inflation pressure should be checked at least once per month. However, Toyota recommends that tire inflation pressure be checked once every two weeks. (→P. 620)**

#### ■ Effects of incorrect tire inflation pressure

Driving with incorrect tire inflation pressure may result in the following:

- Reduced fuel efficiency
- Reduced driving comfort and tire life
- Reduced safety
- Damage to the drive train

If a tire needs frequent inflating, have it checked by any authorized Toyota dealer or repairer, or another duly qualified and equipped professional.

#### ■ Instructions for checking tire inflation pressure

When checking tire inflation pressure, observe the following:

- Check only when the tires are cold.  
If your vehicle has been parked for at least 3 hours or has not been driven for more than 1.5 km or 1 mile, you will get an accurate cold tire inflation pressure reading.
- Always use a tire pressure gauge.  
The appearance of the tire can be misleading. In addition, tire inflation pressure that is even just a few pounds off can affect ride quality and handling.
- Do not reduce tire inflation pressure after driving. It is normal for tire inflation pressure to be higher after driving.
- Never exceed the vehicle capacity weight.  
Passengers and luggage weight should be placed so that the vehicle is balanced.

 CAUTION

■ **Proper inflation is critical to save tire performance**

Keep your tires properly inflated. Otherwise, the following conditions may occur and result in an accident causing death or serious injury:

- Excessive wear
- Uneven wear
- Poor handling
- Possibility of blowouts resulting from overheated tires
- Poor sealing of the tire bead
- Wheel deformation and/or tire separation
- A greater possibility of tire damage from road hazards

 NOTICE

■ **When inspecting and adjusting tire inflation pressure**

Be sure to put the tire valve caps back on. Without the valve caps, dirt or moisture could get into the valve and cause air leakage, which could result in an accident. If the caps are lost, replace them as soon as possible.

### 4-3. Do-it-yourself maintenance

## Wheels

**If a wheel is bent, cracked or heavily corroded, it should be replaced. Otherwise, the tire may separate from the wheel or cause a loss of handling control.**

#### ■ Wheel selection

When replacing wheels, care should be taken to ensure that they are equivalent to those removed in load capacity, diameter, rim width and inset\*.

Replacement wheels are available at any authorized Toyota dealer or repairer, or another duly qualified and equipped professional.

\*: Conventionally referred to as "offset".

Toyota does not recommend using the following:

- Wheels of different sizes or types
- Used wheels
- Bent wheels that have been straightened

#### ■ Aluminum wheel precautions

- Use only Toyota wheel nuts and wrenches designed for use with your aluminum wheels.
- When rotating, repairing or changing your tires, check that the wheel nuts are still tight after driving 1600 km (1000 miles).
- Be careful not to damage the aluminum wheels when using tire chains.
- Use only Toyota genuine balance weights or equivalent and a plastic or rubber hammer when balancing your wheels.

**⚠ CAUTION**

■ **When replacing wheels**

- Do not use wheels that are a different size from those recommended in the Owner's Manual, as this may result in a loss of handling control.
- Never use an inner tube in a leaking wheel which is designed for a tubeless tire. Doing so may result in an accident, causing death or serious injury.

■ **When installing the wheel nuts**

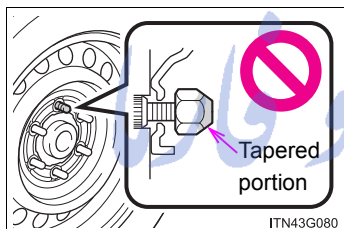

- Be sure to install the wheel nuts with the tapered end facing inward. Installing the nuts with the tapered end facing outward can cause wheel to break and eventually cause a wheel to come off while driving, which could lead to an accident resulting in death or serious injury.

- Never use oil or grease on the wheel bolts or wheel nuts. Oil and grease may cause the wheel nuts to be excessively tightened, leading to bolt or disc wheel damage. In addition, the oil or grease can cause the wheel nuts to loosen and the wheel may fall off, causing an accident and resulting in death or serious injury. Remove any oil or grease from the wheel bolts or wheel nuts.

### 4-3. Do-it-yourself maintenance

## Air conditioning filter

The air conditioning filter must be changed regularly to maintain air conditioning efficiency.

#### ■ Removal method

**STEP 1** Turn the engine switch off.

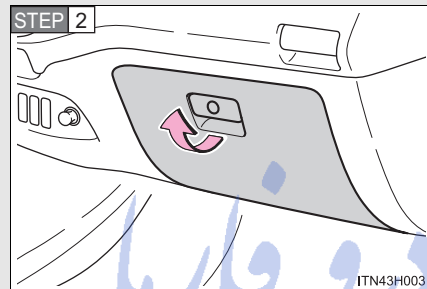

Open the glove box.

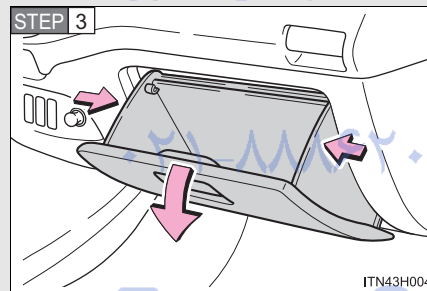

Push in each side of the glove box to disconnect the claws.

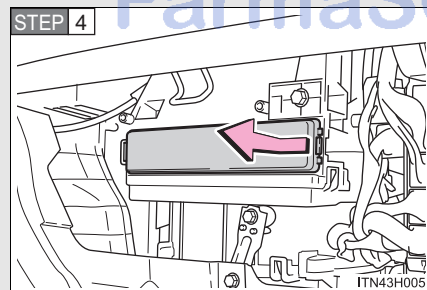

Remove the filter cover.

#### 4-3. Do-it-yourself maintenance

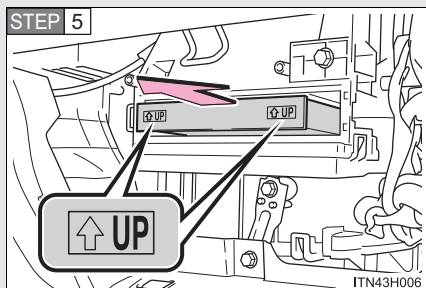

Remove the filter and replace it with a new one.

The “↑UP” marks shown on the filter should be pointing up.

#### ■ Checking interval

Inspect and replace the air conditioning filter according to the maintenance schedule. In dusty areas or areas with heavy traffic flow, early replacement may be required. (For scheduled maintenance information, please refer to the “Toyota Service Booklet” or “Toyota Warranty Booklet”.)

#### ■ If air flow from the vents decreases dramatically

The filter may be clogged. Check the filter and replace if necessary.

#### ⚠ NOTICE

#### ■ When using the air conditioning system

Make sure that a filter is always installed.  
Using the air conditioning system without a filter may cause damage to the system.



### 4-3. Do-it-yourself maintenance

## Wireless remote control battery\*

Replace the battery with a new one if it is depleted.

■ You will need the following items:

- Flathead screwdriver
- Lithium battery CR2016

■ Replacing the battery

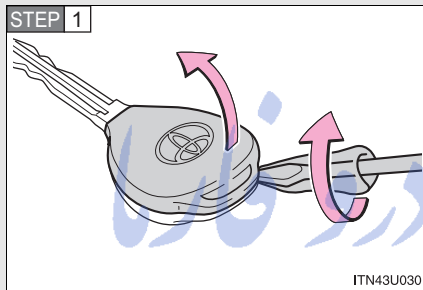

Remove the cover.

To prevent damage to the key, cover the tip of the screwdriver with a rag.

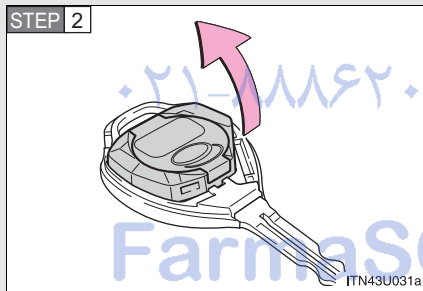

Remove the module.

4

Maintenance and care

\*: If equipped

#### 4-3. Do-it-yourself maintenance

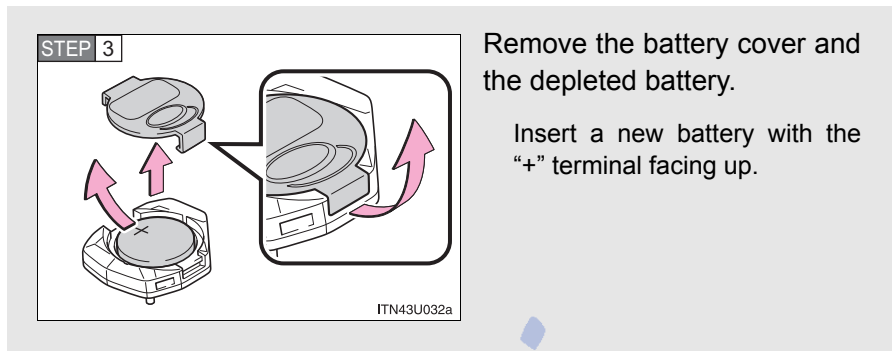

#### ■ Use a CR2016 lithium battery

- Batteries can be purchased at any authorized Toyota dealer or repairer, or another duly qualified and equipped professional, local electrical appliance shops or camera stores.
- Replace only with the same or equivalent type recommended by the manufacturer.
- Dispose of used batteries according to local laws.

#### ■ If the key battery is depleted

The following symptoms may occur:

- The wireless remote control will not function properly.
- The operational range will be reduced.

**⚠ CAUTION****■ Removed battery and other parts**

Keep away from children. These parts are small and if swallowed by a child, they can cause choking. Failure to do so could result in death or serious injury.

**■ Certification for the key battery**

RISK OF EXPLOSION IF BATTERY IS REPLACED BY AN INCORRECT TYPE. DISPOSE OF USED BATTERIES ACCORDING TO THE INSTRUCTIONS.

**⚠ NOTICE****■ For normal operation after replacing the battery**

Observe the following precautions to prevent accidents:

- Always work with dry hands.  
Moisture may cause the battery to rust.
- Do not touch or move any other component inside the remote control.
- Do not bend either of the battery terminals.

FarmaSOS.com

### 4-3. Do-it-yourself maintenance

## Checking and replacing fuses

If any of the electrical components do not operate, a fuse may have blown. If this happens, check and replace the fuses as necessary.

**STEP 1** Turn the engine switch off.

**STEP 2** Open the fuse box cover.

#### Engine compartment

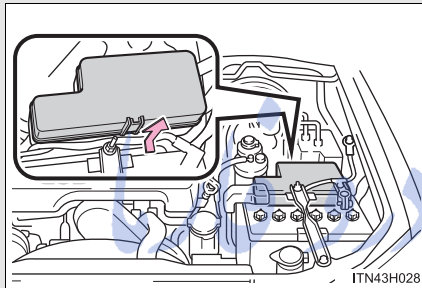

Push the tab in and lift the lid off.

#### Driver's side instrument panel for left-hand drive vehicles (front and rear sides)

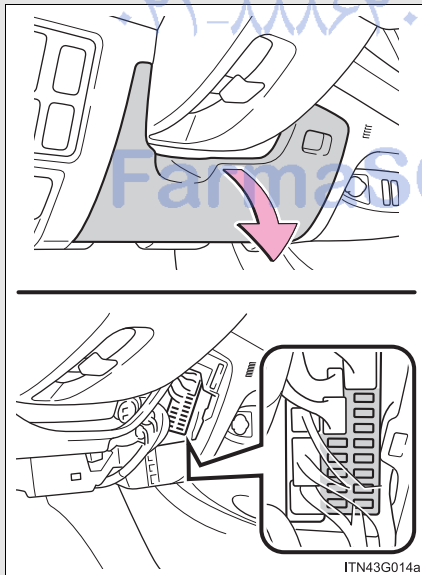

Remove the lower instrument panel.

Rear side: Inspection and replacement of the fuses, contact any authorized Toyota dealer or repairer, or another duly qualified and equipped professional.

**Driver's side instrument panel for right-hand drive vehicles  
(front and rear sides)**

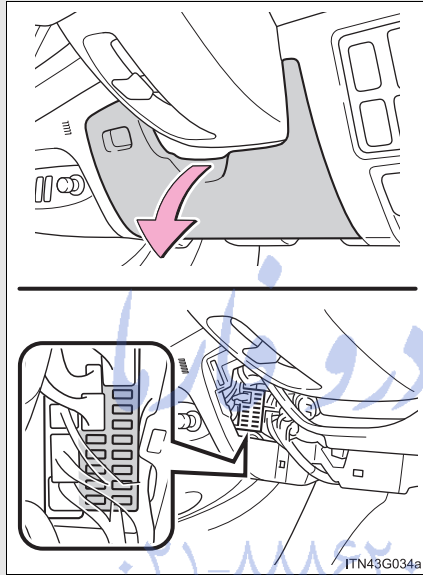

Remove the lower instrument panel.

Rear side: Inspection and replacement of the fuses, contact any authorized Toyota dealer or repairer, or another duly qualified and equipped professional.

**Passenger's side instrument panel for left-hand drive vehicles**

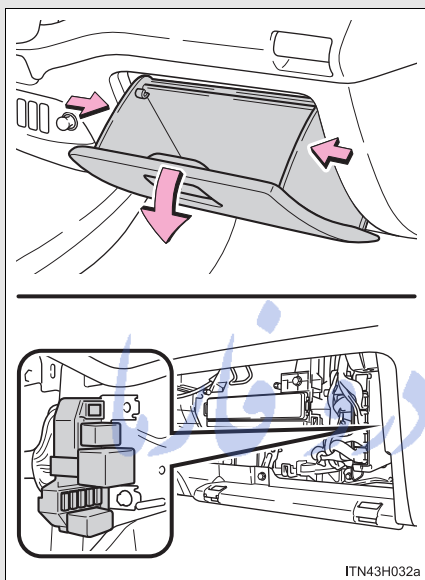

Open the glove box. Push in each side of the glove box to disconnect the claws.

تلفن شبانه روزی: ۰۲۱-۸۸۶۲۰۸۵

FarmaSOS.com

### Passenger's side instrument panel for right-hand drive vehicles

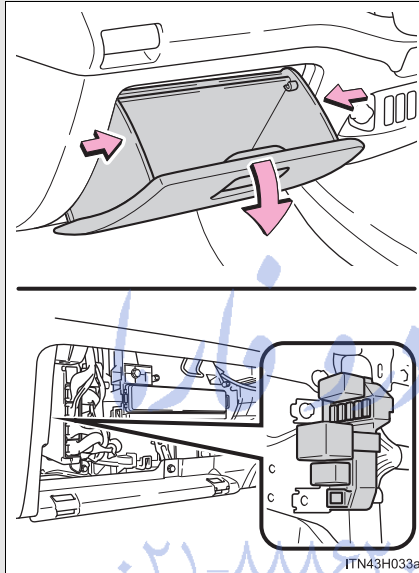

Open the glove box. Push in each side of the glove box to disconnect the claws.

**STEP 3** After a system failure, see “Fuse layout and amperage ratings” (→P. 523) for details about which fuse to check.

**STEP 4** Remove the fuse.

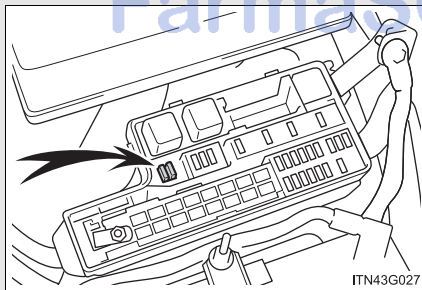

Type A and B fuses can be removed using the pullout tool.

**STEP 5** Check if the fuse is blown.

**Type A**

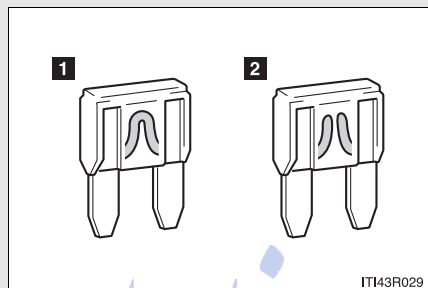

**1** Normal fuse

**2** Blown fuse

Replace the blown fuse with a new fuse of an appropriate amperage rating. The amperage rating can be found on the fuse box lid.

**Type B**

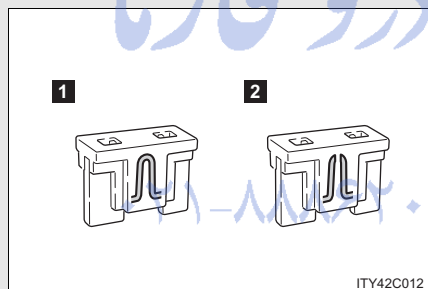

**1** Normal fuse

**2** Blown fuse

Replace the blown fuse with a new fuse of an appropriate amperage rating. The amperage rating can be found on the fuse box lid.

FarmaSOS.com



### Type C

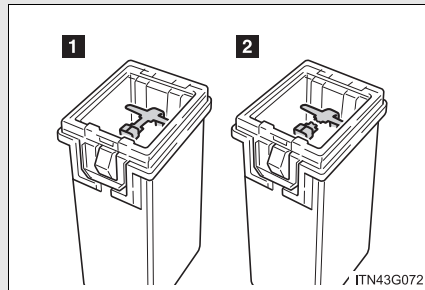

1 Normal fuse

2 Blown fuse

Replace the blown fuse with a new fuse of an appropriate amperage rating. The amperage rating can be found on the fuse box lid.

### Type D

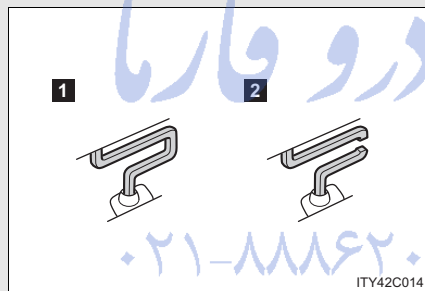

1 Normal fuse

2 Blown fuse

Contact any authorized Toyota dealer or repairer, or another duly qualified and equipped professional.

FarmaSOS.com

### Type E

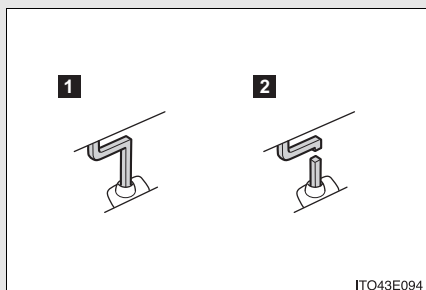

**1** Normal fuse

**2** Blown fuse

Contact any authorized Toyota dealer or repairer, or another duly qualified and equipped professional.

### Type F

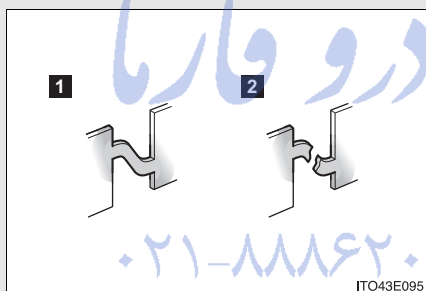

**1** Normal fuse

**2** Blown fuse

Contact any authorized Toyota dealer or repairer, or another duly qualified and equipped professional.

FarmaSOS.com

### Fuse layout and amperage ratings

The provision of fuses and systems connected to the circuit may differ depending on the model and specification.

#### Engine compartment

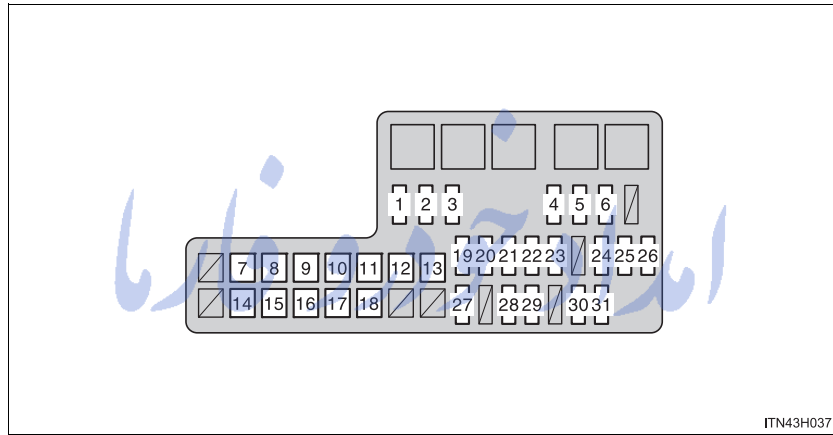

ITN43H037

Fuse	Ampere	Circuit
1	25 A	Spare fuse
2	15 A	Spare fuse
3	10 A	Spare fuse
4	15 A	Front fog lights
5	10 A	Horn
6	25 A	Multipoint fuel injection system/ sequential multipoint fuel injection system
7	50 A	Power heater

#### 4-3. Do-it-yourself maintenance

Fuse		Ampere	Circuit
8	PWR SEAT	30 A	Power seat
9	PTC NO.2	50 A	Power heater
10	H-LP CLN	40 A	Headlight cleaners
11	FR HTR	50 A	Air conditioning system, A/C fuse
12	ABS NO.2	30 A	ABS, TRC and VSC
13	ABS NO.1	40 A	ABS, TRC and VSC
14	ALT	100 A	Charging system, PWR SEAT, H-LP CLN, FR HTR, AM1, IG1, PTC NO.1, PTC NO.2, PWR OUT, STOP, TAIL and OBD fuses
15	GLOW	80 A	Engine glow system
16	BATT P/I	50 A	FOG, HORN and EFI fuses
17	AM2	30 A	Engine starter, ST, IGN, INJ and MET
18	MAIN	40 A	H-LP RH, H-LP LH, H-LP RL and H-LP LL fuses
19	H-LP RL	15 A	Right-hand headlight (Low)
20	H-LP LL	15 A	Left-hand headlight (Low)
21	H-LP RH	15 A	Right-hand headlight (High) and right-hand headlight (Low)
22	H-LP LH	15 A	Left-hand headlight (High) and left-hand headlight (Low)
23	EFI No.2	10 A	Multipoint fuel injection system/ sequential multipoint fuel injection system

	Fuse	Ampere	Circuit
24	ECU-B	10 A	Door courtesy switches, power door lock system, wireless remote control system, steering sensor and headlights
25	RAD	15 A	Audio system
26	DOME	7.5 A	Interior lights, engine switch light, personal light, gauges and meters, clock, multi-information display, wireless remote control system, daytime running light system and fog light
27	A/F	20 A	Emission control system
28	ALT-S	7.5 A	Charging system
29	TURN-HAZ	15 A	Emergency flashers and turn signal lights
30	ECU-B No.2	7.5 A	Air conditioning system
31	DCC	30 A	ECU-B, DOME and RAD fuses

FarmaSOS.com

**Driver's side instrument panel (front side)**

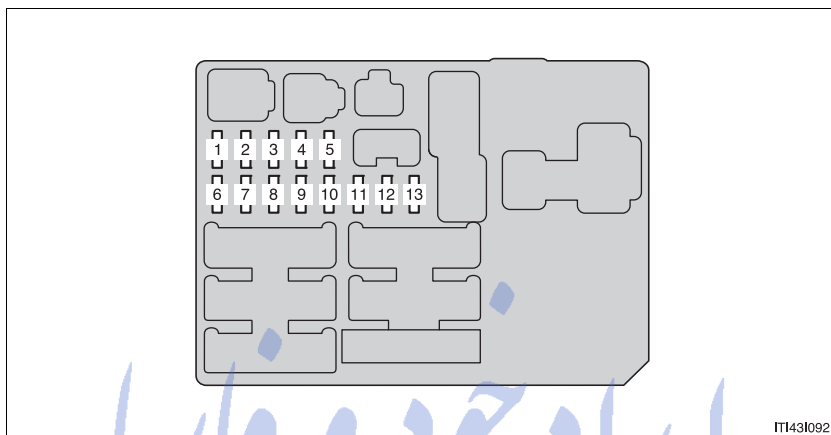

IT1431092

	Fuse	Ampere	Circuit
1	PWR OUT	15 A	Power outlet
2	TAIL	10 A	Instrument panel light, front fog lights, headlight beam level control system, front position lights, tail lights, license plate lights, multipoint fuel injection system/sequential multipoint fuel injection system, multi-information display, daytime running light system and automatic headlight system
3	STOP	10 A	Stop lights, high mounted stoplight, multipoint fuel injection system/sequential multipoint fuel injection system, ABS, TRC, VSC and shift lock control system

	Fuse	Ampere	Circuit
4	OBD	7.5 A	On-board diagnosis system
5	INJ	15 A	Multiport fuel injection system/ sequential multiport fuel injection system
6	ECU-IG & GAUGE	10 A	Air conditioning system, charging system, rear differential lock sys- tem, ABS, TRC, VSC, emergency flashers, turn signal lights, back-up lights, multiport fuel injection sys- tem/sequential multiport fuel injec- tion system, shift lock control system, rear window defogger, headlights, door courtesy switches, power door lock system, wireless remote control system, steering sensor, daytime running light sys- tem, cruise control, headlight clean- ers, seat heaters, outside rear view mirror defoggers, multi-information display and passenger's seat belt reminder light
7	WIP	20 A	Windshield wiper and washer
8	IGN	7.5 A	Multiport fuel injection system/ sequential multiport fuel injection system, SRS airbags and fuel pump
9	ACC	7.5 A	Audio system, power outlet, clock, power rear view mirror control sys- tem, shift lock control system and multi-information display

#### 4-3. Do-it-yourself maintenance

	Fuse	Ampere	Circuit
10	CIG	15 A	Cigarette lighter
11	MET	7.5 A	Gauges and meters and DPF system
12	A/C	10 A	Air conditioning system
13	ST	7.5 A	Starting system, gauges and meters and multiport fuel injection system/sequential multiport fuel injection system

امداد خودرو فارما

تلفن شبانه روزی: ۰۲۱-۸۸۸۶۲۰۸۵

FarmaSOS.com



**Driver's side instrument panel (rear side)**

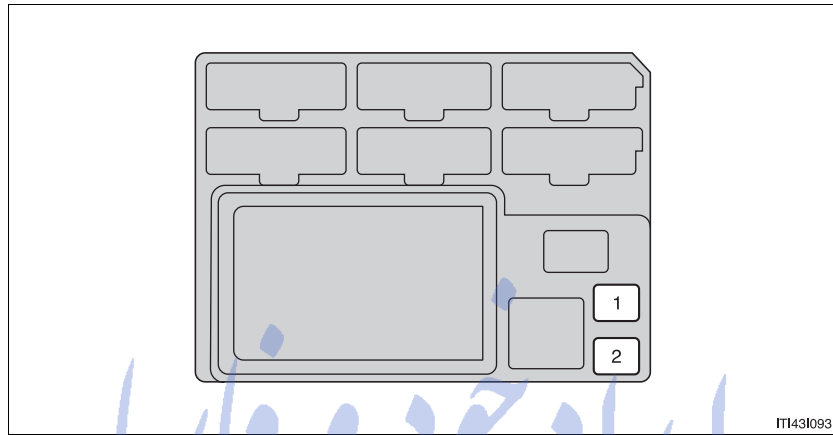

	Fuse	Ampere	Circuit
1	AM1	40 A	Rear differential lock system, ABS, TRC, VSC, ACC, CIG, ECU-IG & GAUGE, and WIP fuses
2	IG1	40 A	PWR, S-HTR, 4WD, DOOR, DEF and MIR HTR fuses

4

Maintenance and care

FarmaSOS.com

### Passenger's side instrument panel

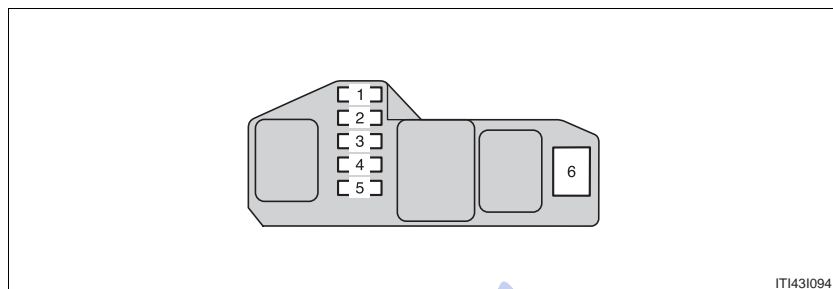

	Fuse	Ampere	Circuit
1	MIR-HTR	15 A	Outside rear view mirror defoggers
2	4WD	20 A	Rear differential lock system, ABS, TRC and VSC
3	S-HTR	15 A	Seat heaters
4	DEF	20 A	Rear window defogger and multiport fuel injection system/sequential multiport fuel injection system
5	DOOR	25 A	Power door lock system and power windows
6	PWR	30 A	Power windows

FarmaSOS.com

#### ■ After a fuse is replaced

- If the lights do not turn on even after the fuse has been replaced, a bulb may need replacement. (→P. 532)
- If the replaced fuse blows again, have the vehicle inspected by any authorized Toyota dealer or repairer, or another duly qualified and equipped professional.

#### ■ If there is an overload in a circuit

The fuses are designed to blow, protecting the wiring harness from damage.

#### ⚠ CAUTION

##### ■ To prevent system breakdowns and vehicle fire

Observe the following precautions.

Failure to do so may cause damage to the vehicle, and possibly a fire or injury.

- Never use a fuse of a higher amperage rating than that indicated, or use any other object in place of a fuse.
- Always use a genuine Toyota fuse or equivalent.  
Never replace a fuse with a wire, even as a temporary fix.
- Do not modify the fuses or fuse boxes.

#### ⚠ NOTICE

##### ■ Before replacing fuses

Have the cause of electrical overload determined and repaired by any authorized Toyota dealer or repairer, or another duly qualified and equipped professional, as soon as possible.

## 4-3. Do-it-yourself maintenance

### Light bulbs

You may replace the following bulbs by yourself. The difficulty level of replacement varies depending on the bulb. As there is a danger that components may be damaged, we recommend that replacement is carried out by any authorized Toyota dealer or repairer, or another duly qualified and equipped professional.

#### ■ Preparing for light bulb replacement

Check the wattage of the light bulb to be replaced. (→P. 622)

#### ■ Front bulb locations

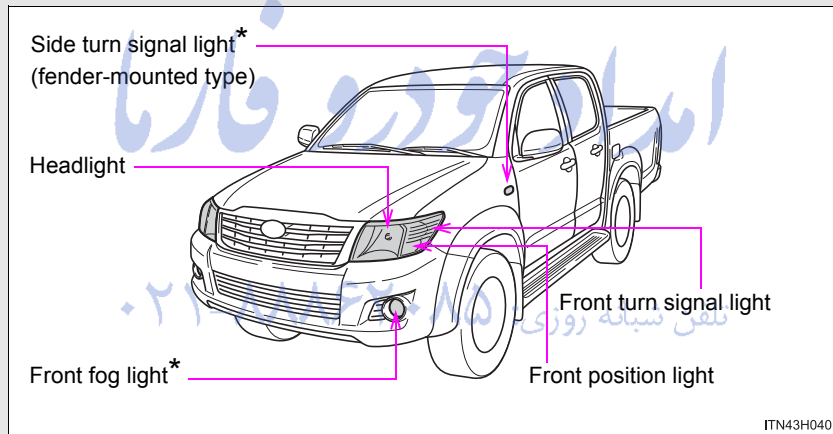

### ■ Rear bulb locations

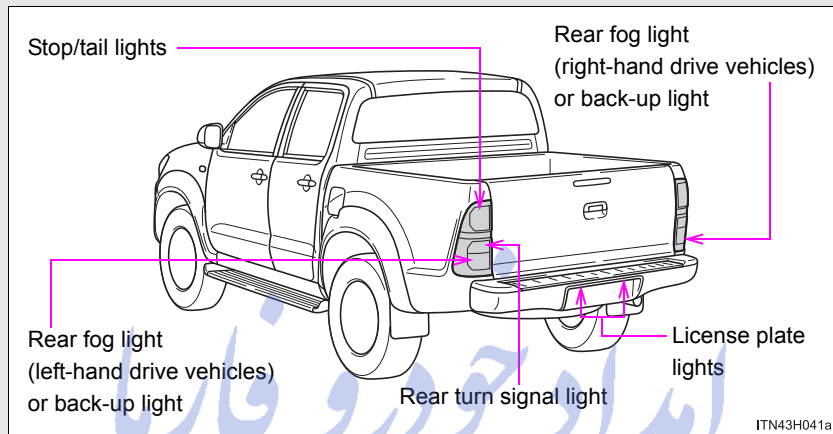

\*: If equipped

### Replacing light bulbs

#### ■ Headlight

**STEP 1** Before replacing the bulbs (right side only):

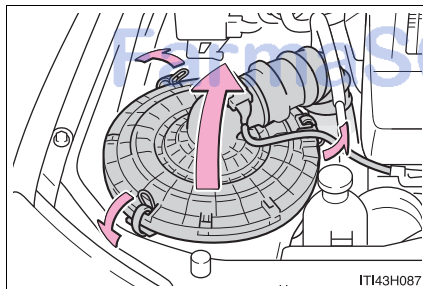

Release the clips of the air cleaner filter cover, and remove the cover to allow easy access to the light bulbs.

### 4-3. Do-it-yourself maintenance

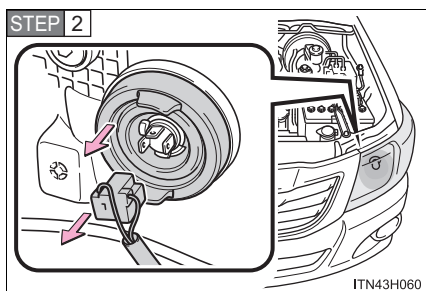

Unplug the connector and remove the rubber cover.

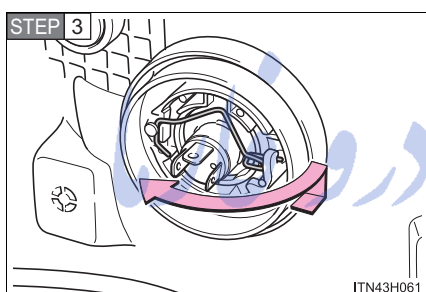

Release the bulb retaining spring.

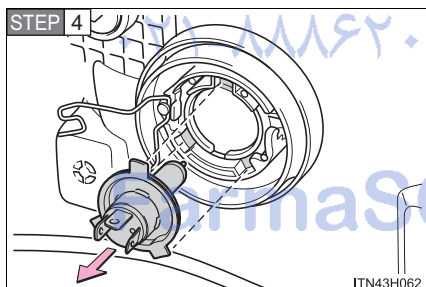

Remove the bulb.

To install a new bulb, align the tabs of the bulb with the cutouts of the mounting hole.

■ Front fog lights (if equipped)

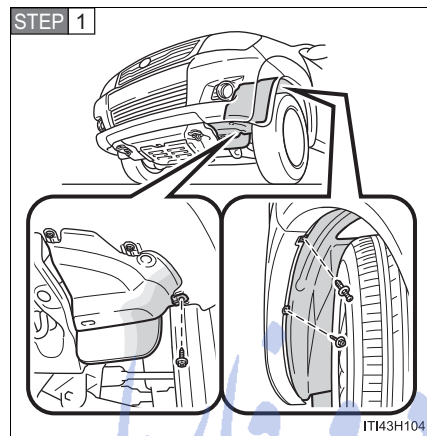

To allow enough working space, turn the steering wheel to the opposite side of the bulb to be replaced.

Remove the bolts and clip.

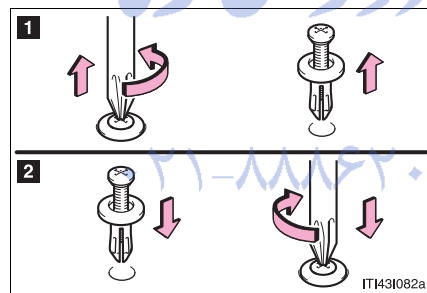

1 Removing the clip

2 Installing the clip

FarmaSOS.com

4-3. Do-it-yourself maintenance

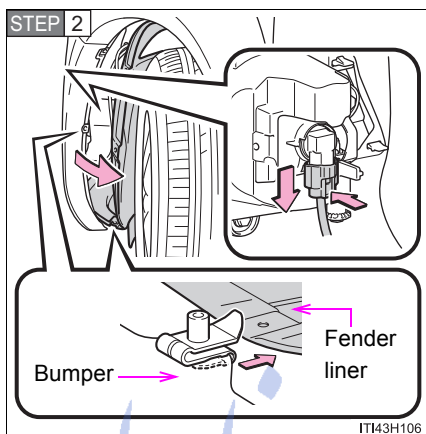

Partly remove the fender liner and unplug the connector while pressing the lock release.

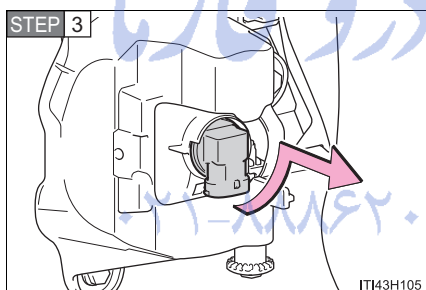

Turn the bulb base counterclockwise.

FarmaSOS.com



■ Front position lights

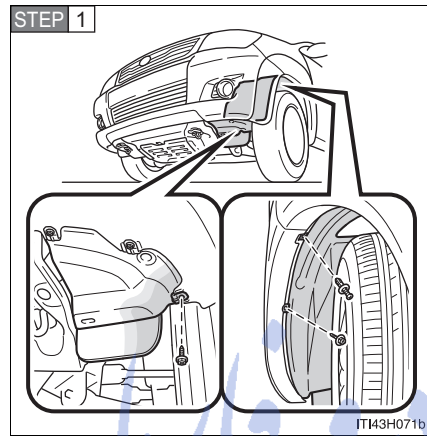

To allow enough working space, turn the steering wheel to the opposite side of the bulb to be replaced.

Remove the bolts and clip.

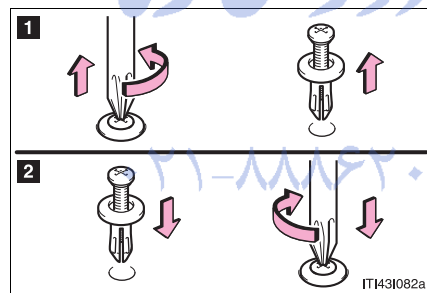

1 Removing the clip

2 Installing the clip

4-3. Do-it-yourself maintenance

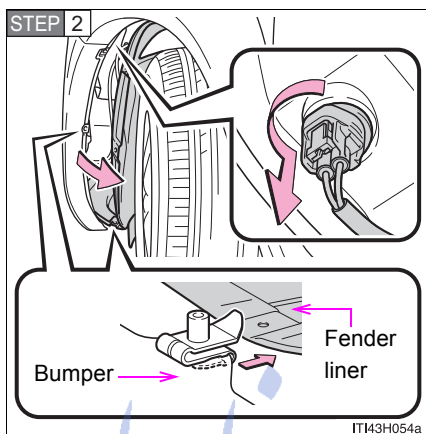

Partly remove the fender liner and turn the bulb base counter-clockwise.

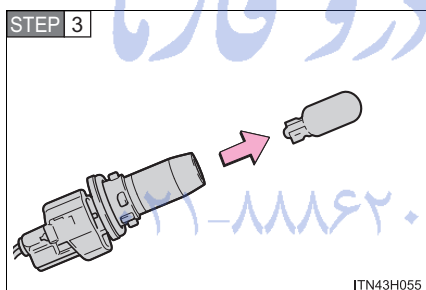

Remove the light bulb.

اردو خودرو فارما  
تلفن شبانه روزی: ۰۸۵-۱۱۶۲۰۸۵  
FarmaSOS.com

■ Front turn signal lights

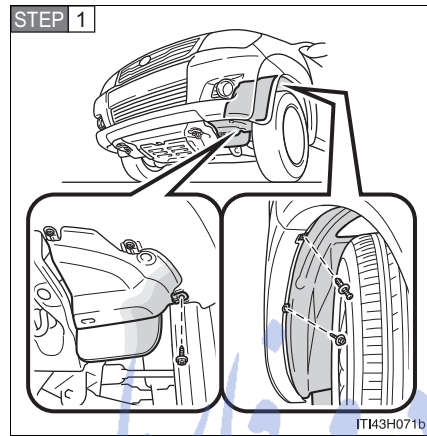

To allow enough working space, turn the steering wheel to the opposite side of the bulb to be replaced.

Remove the bolts and clip.

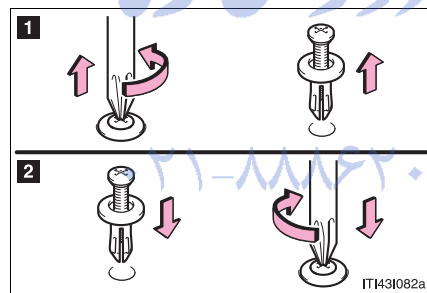

1 Removing the clip

2 Installing the clip

4-3. Do-it-yourself maintenance

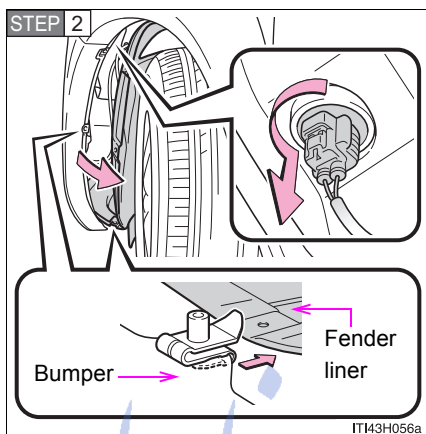

Partly remove the fender liner and turn the bulb base counter-clockwise.

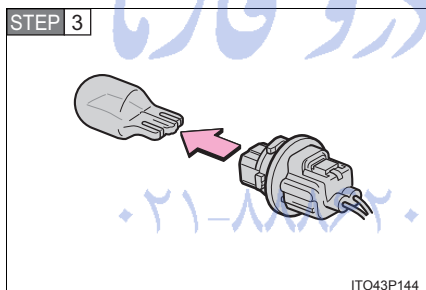

Remove the light bulb.

ارداد خودرو فارما  
تلفن شبانه روزی: ۰۲۱-۸۸۲۲۰۸۵  
FarmaSOS.com

■ Side turn signal lights (fender-mounted type) (if equipped)

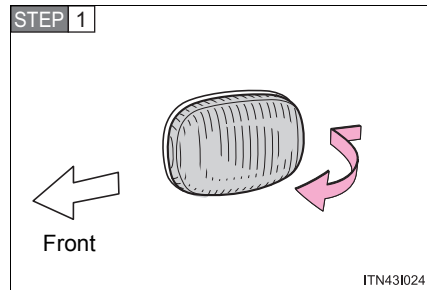

Remove the unit.

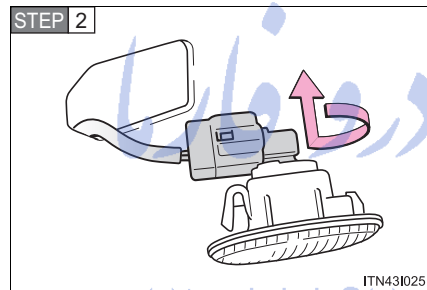

Turn the bulb base counterclockwise.

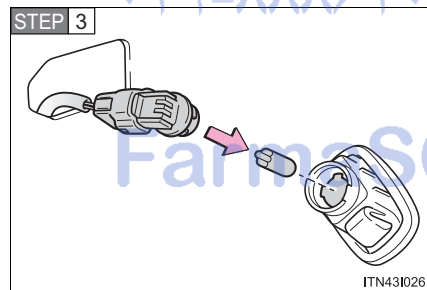

Remove the light bulb.

■ Stop/tail lights, rear turn signal lights, back-up lights and rear fog light

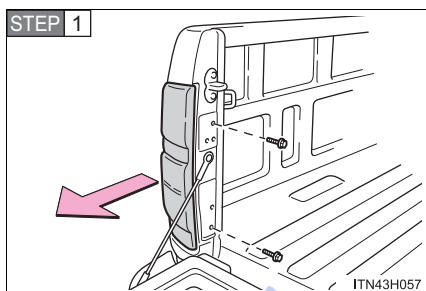

Remove the securing bolts and remove the unit.

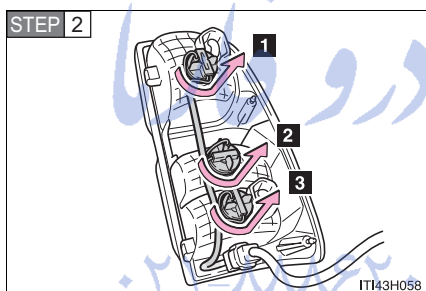

Turn the bulb base counterclockwise.

- 1 Stop/tail light
- 2 Rear turn signal light
- 3 Back-up light or rear fog light

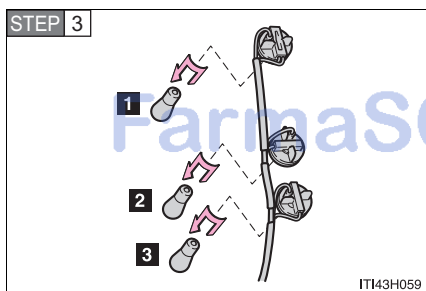

Remove the light bulb.

- 1 Stop/tail light
- 2 Rear turn signal light
- 3 Back-up light or rear fog light

■ License plate lights

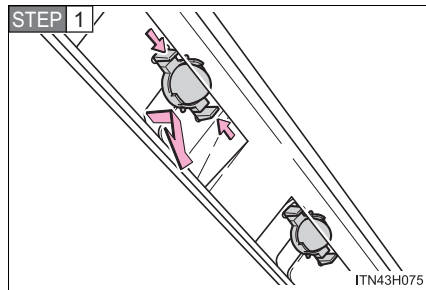

Remove the unit.

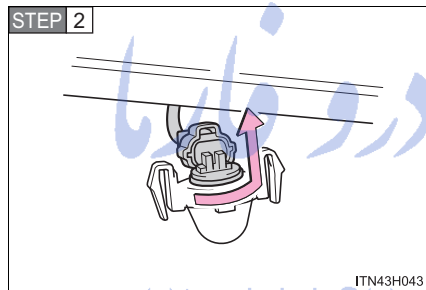

Turn the bulb base counterclockwise.

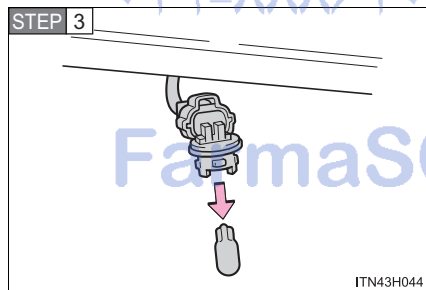

Remove the light bulb.

#### ■ Replacing the following bulbs

If any of the lights listed below has burnt out, have it replaced by any authorized Toyota dealer or repairer, or another duly qualified and equipped professional.

- Side turn signal lights (mirror-mounted type) (if equipped)
- High mounted stoplight (if equipped)

#### ■ When installing the rubber cover of the headlight

Ensure the rubber cover is securely attached.

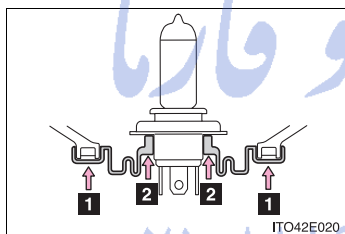

- 1 Fit the rubber cover outer circumference in firmly.
- 2 Fit the rubber cover around the light bulb in until the light bulb plug can be seen.

#### ■ LED light bulbs

The high mounted stoplight consists of a number of LEDs. If any of the LEDs burn out, take your vehicle to any authorized Toyota dealer or repairer, or another duly qualified and equipped professional to have the light replaced.

#### ■ Condensation build-up on the inside of the lens

Contact any authorized Toyota dealer or repairer, or another duly qualified and equipped professional for more information in the following situations. Temporary condensation build-up on the inside of the headlight lens does not indicate a malfunction.

- Large drops of water have built up on the inside of the lens.
- Water has built up inside the headlight.



 CAUTION

■ **Replacing light bulbs**

- Turn off the lights. Do not attempt to replace the bulb immediately after turning off the lights.  
The bulbs become very hot and may cause burns.
  - Do not touch the glass portion of the light bulb with bare hands. Hold the bulb by the plastic or metal portion.  
If the bulb is scratched or dropped, it may blow out or crack.
  - Fully install light bulbs and any parts used to secure them. Failure to do so may result in heat damage, fire, or water entering the headlight unit. This may damage the headlights or cause condensation to build up on the lens.
- **To prevent damage or fire**
- Make sure bulbs are fully seated and locked.
  - Check the wattage of the bulb before installing to prevent heat damage.

تلفن شبانه روزی: ۰۲۱-۸۸۶۲۰۸۵

FarmaSOS.com

امداد خودرو فارما

تلفن شبانه روزی: ۰۲۱-۸۸۸۶۲۰۸۵

**FarmaSOS.com**

## When trouble arises

# 5

### 5-1. Essential information

Emergency flashers .....	546
If your vehicle needs to be towed .....	547
If you think something is wrong .....	553
Fuel pump shut off system .....	554

### 5-2. Steps to take in an emergency

If a warning light turns on or a warning buzzer sounds .....	555
If you have a flat tire .....	563
If the engine will not start .....	582
If the shift lever cannot be shifted from P .....	583
If you lose your keys .....	584
If the vehicle battery is discharged .....	585
If your vehicle overheats .....	590
If you run out of fuel and the engine stalls .....	593
If the vehicle becomes stuck .....	594
If your vehicle has to be stopped in an emergency .....	596

## 5-1. Essential information

### Emergency flashers

Use the emergency flashers if the vehicle malfunctions or is involved in an accident.

#### Vehicles without automatic air conditioning system

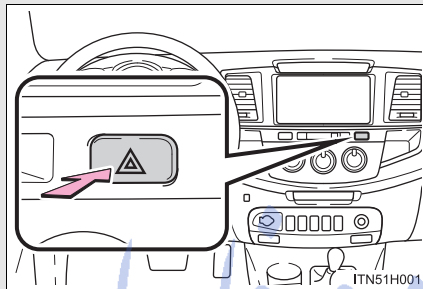

Press the switch to flash all the turn signal lights. To turn them off, press the switch once again.

#### Vehicles with automatic air conditioning system

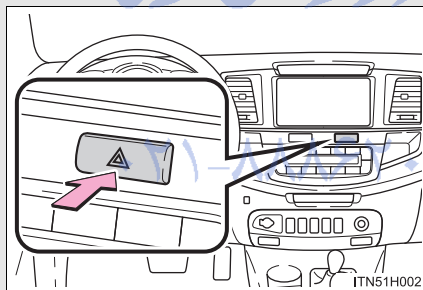

Press the switch to flash all the turn signal lights. To turn them off, press the switch once again.

#### NOTICE

##### ■ To prevent battery discharge

Do not leave the emergency flashers on longer than necessary when the engine is not running.

## 5-1. Essential information

### If your vehicle needs to be towed

If towing is necessary, we recommend having your vehicle towed by any authorized Toyota dealer or repairer, or another duly qualified and equipped professional, such as a commercial towing service, using a lift-type truck or flatbed truck.

Use a safety chain system for all towing, and abide by all state/provincial and local laws.

#### Before towing

The following may indicate a problem with your transmission. Contact any authorized Toyota dealer or repairer, or another duly qualified and equipped professional, before towing.

- The engine is running but the vehicle will not move.
- The vehicle makes an abnormal sound.

تلفن شبانه روزی: ۰۲۱-۸۸۶۲۰۸۵

FarmaSOS.com

5

When trouble arises

### Emergency towing

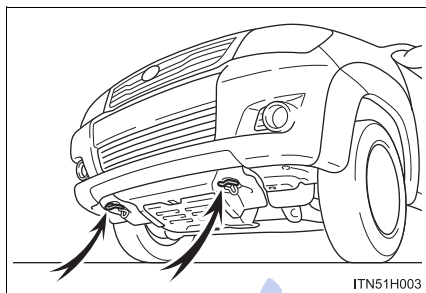

If a tow truck is not available in an emergency, your vehicle may be temporarily towed using a cable or chain secured to the emergency towing eyelet(s). This should only be attempted on hard surfaced roads for short distances at low speeds.

A driver must be in the vehicle to steer and operate the brakes. The vehicle's wheels, drive train, axles, steering and brakes must be in good condition.

تلفن شبانه روزی: ۰۲۱-۸۸۶۲۰۸۵

FarmaSOS.com

**Towing with a sling-type truck**

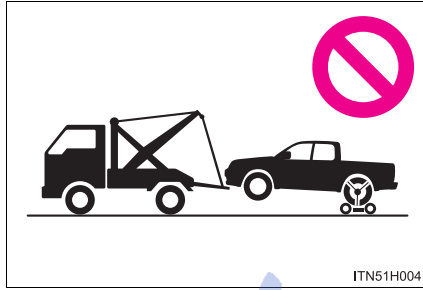

Do not tow with a sling-type truck to prevent body damage.

امداد خودرو فارما

تلفن شبانه روزی: ۰۲۱-۸۸۸۶۲۰۸۵

FarmaSOS.com

### Towing with a wheel-lift type truck

#### From the front

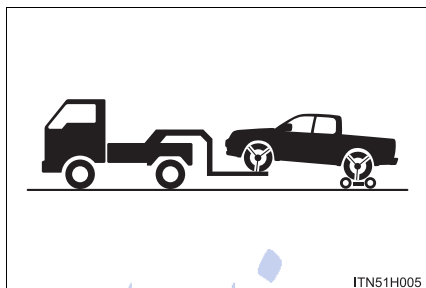

Vehicles with automatic transmission: Use a towing dolly under the rear wheels.

Vehicles with manual transmission: We recommend using a towing dolly under the rear wheels.

When not using a towing dolly, release the parking brake and shift the shift lever to N.

#### From the rear (Pre Runner)

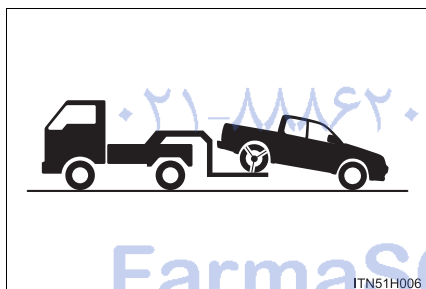

Turn the engine switch to the "ACC" position so that the steering wheel is unlocked.

تلفن شبانه روزی: ۰۲۱-۸۸۶۲۰۸۵

#### From the rear (4WD models)

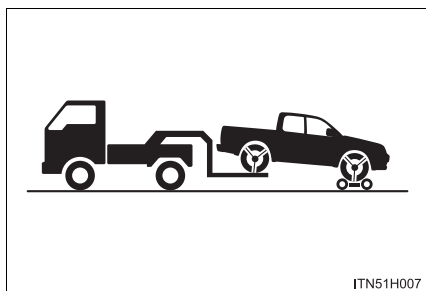

Use a towing dolly under the front wheels.

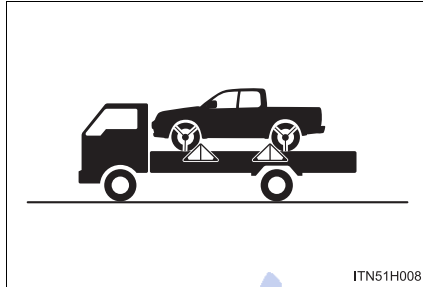

**Using a flatbed truck**

If you use chains or cables to tie down your vehicle, the angles shaded in black must be 45°.

Do not overly tighten the tie downs or the vehicle may be damaged.

**■ Before emergency towing**

- STEP 1** Release the parking brake.
- STEP 2** 4WD models: Shift the front drive control lever to H2.
- STEP 3** Shift the shift lever to N.
- STEP 4** Turn the engine switch to the "ACC" (engine off) or "ON" (engine running) position.

**⚠ CAUTION**
**■ Caution while towing**

- Use extreme caution when towing the vehicle. Avoid sudden starts or erratic driving maneuvers which place excessive stress on the emergency towing eyelets and the cables or chains. Always be cautious of the surroundings and other vehicles while towing.
- If the engine is not running, the power assist for the brakes and steering will not function, making steering and braking more difficult.

 NOTICE

- **To prevent causing serious damage to the transmission and transfer (4WD models) when towing using a wheel-lift type truck (vehicles with automatic transmission)**

Pre Runner: Never tow this vehicle from the front with the rear wheels on the ground.

4WD models: Never tow this vehicle with any of the wheels in contact with the ground.

- **To prevent damage to the vehicle when towing using a wheel-lift type truck (vehicles with manual transmission)**

- Do not tow the vehicle from the rear when the engine switch is in the "LOCK" position or the key is removed. The steering lock mechanism is not strong enough to hold the front wheels straight.

- When raising the vehicle, ensure adequate ground clearance for towing at the opposite end of the raised vehicle. Without adequate clearance, the vehicle could be damaged while being towed.

- **To prevent body damage when towing with a sling-type truck**

Do not tow with a sling-type truck, either from the front or rear.

FarmaSOS.com

## 5-1. Essential information

### If you think something is wrong

If you notice any of the following symptoms, your vehicle probably needs adjustment or repair. Contact any authorized Toyota dealer or repairer, or another duly qualified and equipped professional, as soon as possible.

#### ■ Visible symptoms

- Fluid leaks under the vehicle.  
(Water dripping from the air conditioning after use is normal.)
- Flat-looking tires or uneven tire wear
- Engine coolant temperature gauge needle continually points higher than normal.

#### ■ Audible symptoms

- Changes in exhaust sound
- Excessive tire squeal when cornering
- Strange noises related to the suspension system
- Pinging or other noises related to the engine

#### ■ Operational symptoms

- Engine missing, stumbling or running roughly
- Appreciable loss of power
- Vehicle pulls heavily to one side when braking
- Vehicle pulls heavily to one side when driving on a level road
- Loss of brake effectiveness, spongy feeling, pedal almost touches the floor

5

When trouble arises

## 5-1. Essential information

### Fuel pump shut off system

To minimize the risk of fuel leakage when the engine stalls or when an airbag inflates upon collision, the fuel pump shut off system stops the supply of fuel to the engine.

Follow the procedure below to restart the engine after the system is activated.

**STEP 1** Turn the engine switch to the “ACC” or “LOCK” position.

**STEP 2** Restart the engine.

#### NOTICE

■ **Before starting the engine**

Inspect the ground under the vehicle.

If you find that fuel has leaked onto the ground, the fuel system has been damaged and is in need of repair. Do not restart the engine.

تلفن شبانه روزی: ۰۲۱-۸۸۶۲۰۸۵

FarmaSOS.com

## 5-2. Steps to take in an emergency

### If a warning light turns on or a warning buzzer sounds

Calmly perform the following actions if any of the warning lights comes on or flashes. If a light comes on or flashes, but then goes off, this does not necessarily indicate a malfunction in the system. However, if this continues to occur, have the vehicle inspected by any authorized Toyota dealer or repairer, or another duly qualified and equipped professional.

**Stop the vehicle immediately. Continuing to drive the vehicle may be dangerous.**

The following warning indicates a possible problem in the brake system. Immediately stop the vehicle in a safe place and contact any authorized Toyota dealer or repairer, or another duly qualified and equipped professional.



Warning light	Warning light/Details
	<p><b>Brake system warning light</b></p> <ul style="list-style-type: none"><li>• Low brake fluid</li><li>• Malfunction in the brake system</li></ul> <p>This light also comes on when the parking brake is not released. If the light turns off after the parking brake is fully released the system is operating normally.</p> <ul style="list-style-type: none"><li>• Low negative pressure in the vacuum tank</li></ul>

5

When trouble arises

**Stop the vehicle immediately.**









The following warning indicates the possibility of damage to the vehicle that may lead to an accident. Immediately stop the vehicle in a safe place and contact any authorized Toyota dealer or repairer, or another duly qualified and equipped professional.

Warning light	Warning light/Details
	<b>Charging system warning light</b> Indicates a malfunction in the vehicle's charging system
	<b>Low engine oil pressure warning light</b> Indicates that the engine oil pressure is too low



**Have the vehicle inspected immediately.**

Failure to investigate the cause of the following warnings may lead to the system operating abnormally and possibly cause an accident. Have the vehicle inspected by any authorized Toyota dealer or repairer, or another duly qualified and equipped professional immediately.

Warning light	Warning light/Details
	<b>Malfunction indicator lamp</b> Indicates: <ul style="list-style-type: none"> <li>• Malfunction in the emission control system.*1</li> <li>• Malfunction in the electronic engine control system.</li> <li>• The boost pressure in the turbocharger is abnormally high.*2</li> <li>• Malfunction in DPF system</li> </ul>

Warning light	Warning light/Details
	<b>SRS warning light</b> Indicates a malfunction in: <ul style="list-style-type: none"> <li>• The SRS airbag system; or</li> <li>• The seat belt pretensioner system</li> </ul>
	<b>ABS warning light</b> Indicates a malfunction in: <ul style="list-style-type: none"> <li>• The ABS; or</li> <li>• The brake assist system (vehicles with VSC system)</li> </ul>
 (flashes) and 	<b>VSC OFF and slip indicator lights (if equipped)</b> Indicates a malfunction in: <ul style="list-style-type: none"> <li>• Vehicle stability control; or</li> <li>• Traction control</li> </ul>
 (flashes)	<b>Four-wheel drive indicator light</b> Indicates a malfunction in the four-wheel drive system (→P. 212)
	<b>Cruise control indicator light*<sup>3</sup> (if equipped)</b> Indicates a malfunction in the cruise control system (→P. 202)
	<b>Automatic transmission fluid temperature warning light (if equipped)</b> Indicates that the automatic transmission fluid temperature is too high.
	<b>Timing belt replacement warning light</b> Indicates that the timing belt should be replaced

## 5-2. Steps to take in an emergency

Warning light	Warning light/Details
	<p><b>Fuel system warning light</b></p> <p>Indicates:</p> <ul style="list-style-type: none"> <li>• The amount of accumulated water in the fuel filter has reached the specified level if the light flashes. (→P. 502)</li> <li>• The fuel filter need to be replaced if the light comes on.</li> </ul>
	<p><b>DPF system warning light</b></p> <p>Indicates:</p> <ul style="list-style-type: none"> <li>• Vehicles without DPF system switch: The amount of accumulated deposit in the DPF catalytic converter has reached the specified level if the light comes on. Regenerate the filter. (→P. 563)</li> <li>• Vehicles without DPF system switch: Malfunction in the DPF system if the light flashes.</li> <li>• Vehicles with DPF system switch: Regenerate the filter with the DPF system switch if the light turns on or flashes. (→P. 227)</li> </ul>

\*1: If equipped

\*2: Slow down until the lamp goes off. تلفن شبانه روزی: ۰۸۵ ۲۱ ۸۸۶۲





\*3: The light turns to yellow (except for Russia and Ukraine) or flashes (for Russia and Ukraine).

FarmaSOS.com





**Follow the correction procedures.**

After taking the specified steps to correct the suspected problem, check that the warning light goes off.

Warning light	Warning light/Details	Correction procedure
	<b>Open door warning light</b> Indicates that a door is not fully closed	Check that all the doors are closed.
	<b>Low fuel level warning light</b> Indicates remaining fuel is approximately 12.0 L (3.2 gal., 2.6 Imp.gal.) or less	Refuel the vehicle.
 (for driver)	<b>Driver's seat belt reminder light (warning buzzer)*</b> Warns the driver to fasten his/her seat belt	Fasten the seat belt.
 PASSENGER (for front passenger)	<b>Front passenger's seat belt reminder light</b> Warns the front passenger to fasten his/her seat belt	Fasten the seat belt.
 A/T P	<b>Unengaged "Park" warning light (if equipped)</b> The transmission "Park" mechanism is not engaged.	Shift front drive control lever to "H2" or "H4" or "L4".

## 5-2. Steps to take in an emergency

Warning light	Warning light/Details	Correction procedure
	<p><b>Low engine oil level warning light</b> Indicates that engine oil level is low</p>	Check the level of engine oil and add more oil if necessary.
 (remains on)	<p><b>Engine oil change reminder light</b> Except for Russia and Ukraine Indicates that the engine oil should be changed Comes on approximately 30000 km (18000 miles) after the engine oil has been changed (and the oil maintenance date has been reset) For Russia and Ukraine You have forgotten to reset the oil change system Change the engine oil in accordance with the maintenance schedule.</p>	Have the engine oil and oil filter checked and/or changed by any authorized Toyota dealer or repairer, or another duly qualified and equipped professional. After changing the engine oil, the oil change system should be reset. (→P. 491)

\*: Driver's seat belt buzzer:

The driver's seat belt buzzer sounds to alert the driver that his or her seat belt is not fastened. The buzzer sounds intermittently for 30 seconds after the vehicle reaches a speed of 15 km/h (9 mph). Then, if the seat belt is still unfastened, the buzzer will sound in a different tone for 90 more seconds.

---

■ **If the malfunction indicator lamp comes on while driving**

For some models, the malfunction indicator lamp will come on if the fuel tank becomes completely empty. If the fuel tank is empty, refuel the vehicle immediately. The malfunction indicator lamp will go off after several trips.

If the malfunction indicator lamp does not go off, contact any authorized Toyota dealer or repairer, or another duly qualified and equipped professional.

■ **Key reminder buzzer**

The buzzer indicates that the key has not been removed with the engine off and the driver's door opened.

■ **If the DPF system warning light comes on**

The deposit collected in the filter needs to be regenerated.

To regenerate the filter, the following driving methods are recommended\*:

- By driving continuously (for example, at around 60 km/h [37 mph] for approximately 20 minutes).
- By avoiding short trips, or by driving continuously (leaving the engine running for long periods of time).

The DPF warning light will extinguish when regeneration is complete. However, if this driving cannot be carried out, or if the light does not extinguish even after driving, have the vehicle inspected by any authorized Toyota dealer or repairer, or another duly qualified and equipped professional immediately.

For details of the DPF system. (→P. 227)

\*: When driving, pay sufficient attention to weather, road conditions, terrain and traffic conditions, and drive according to traffic laws.

 CAUTION

■ **If both the ABS and the brake system warning lights remain on (vehicles with VSC system)**

Stop your vehicle in a safe place immediately and contact any authorized Toyota dealer or repairer, or another duly qualified and equipped professional. The vehicle will become extremely unstable during braking, and the ABS system may fail, which could cause an accident resulting in death or serious injury.

 NOTICE

■ **If the malfunction indicator lamp comes on when the boost pressure in the turbocharger is abnormally high**

Never drive at high speed or race the engine even after the lamp goes off.

■ **If the fuel system warning light flashes**

Never drive the vehicle with the warning light flashing. Continued driving with water accumulated in the fuel filter will damage the fuel injection pump.

FarmaSOS.com

## 5-2. Steps to take in an emergency If you have a flat tire

Remove the flat tire and replace it with the spare tire provided.

### ■ Before jacking up the vehicle

- Stop the vehicle on a hard, flat surface.
- Set the parking brake.
- Shift the shift lever to P (automatic transmission) or R (manual transmission).
- Stop the engine.
- Turn on the emergency flashers. (→P. 548)

### ■ Location of the spare tire

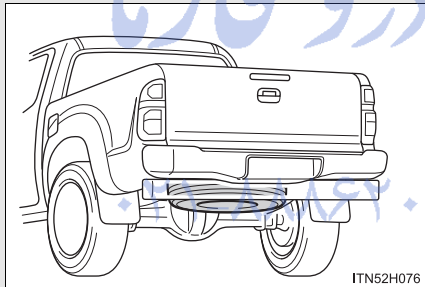

### ■ Location of the jack and tools

Single-cab models

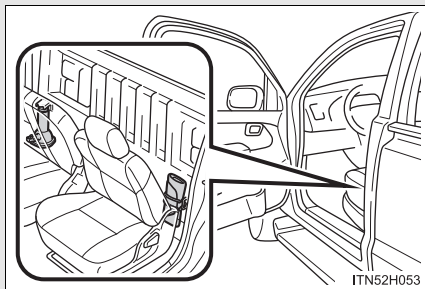

The jack and tools are stored behind the seat.

5

When trouble arises

## 5-2. Steps to take in an emergency

### Extra-cab models

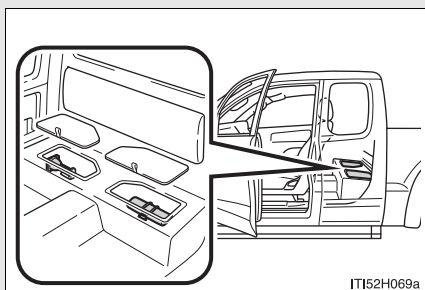

The jack and tools are stored under the lid.

### Double-cab models

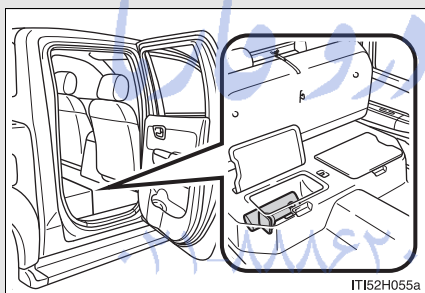

The jack and tools are stored under the bottom cushion.

تلفن شبانه روزی: ۱۵۷۴۶۲

FarmaSOS.com

### Taking out the jack and tools

#### Single-cab models

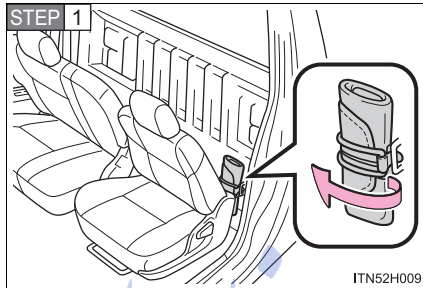

Unhook the strap and take out the tool bag.

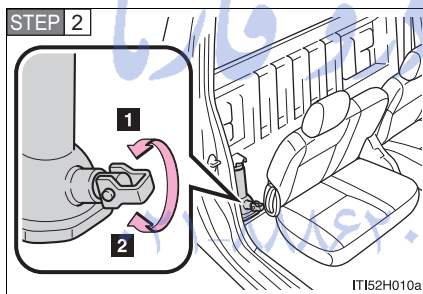

Take out the jack.

- 1 For loosening
- 2 For tightening

FarmaSOS.com

5-2. Steps to take in an emergency

**Extra-cab models**

**STEP 1** Vehicles with rear seat cushions: Remove the rear seat cushions. (→P. 72)

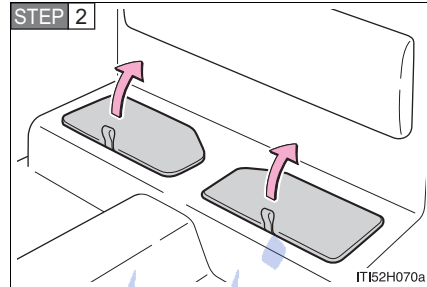

Pull the tag and open the lid.

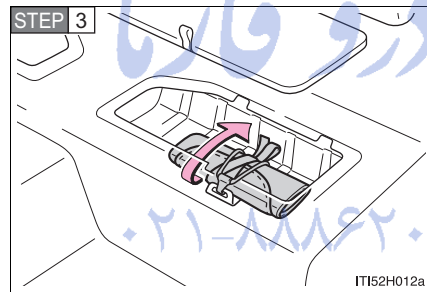

Unhook the strap and take out the tool bag.

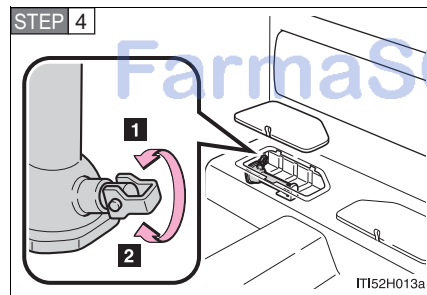

Take out the jack.

- 1** For loosening
- 2** For tightening



### Double-cab models

**STEP 1** Tumbling the bottom cushion (→P. 73)

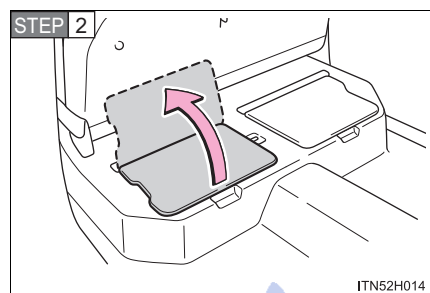

Open the lid.

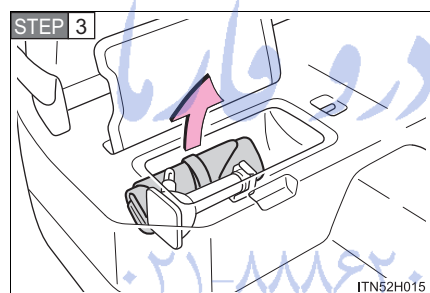

Take out the tool bag.

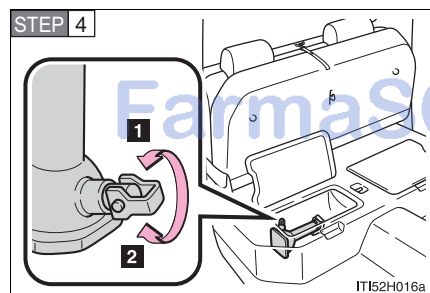

Take out the jack.

- 1** For loosening
- 2** For tightening

### Taking out the spare tire

#### STEP 1 Assembling the jack handle.

Remove the jack handle end, jack handle extensions and wheel nut wrench from the tool bag and assemble by following these steps.

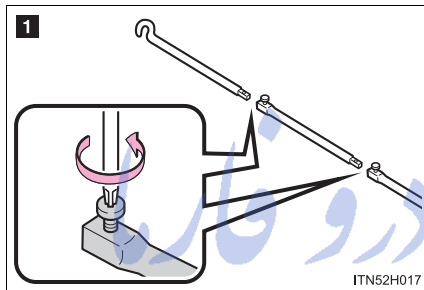

**1** Loosen the bolts using a screwdriver.

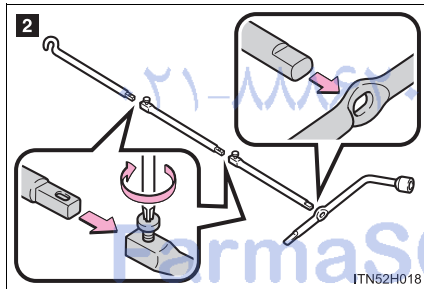

**2** Assemble the jack handle end, jack handle extensions and wheel nut wrench and tighten the bolts.

Check that the bolts are firmly tightened.

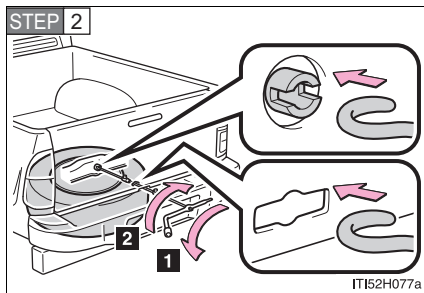

Insert the jack handle extension into the lowering screw.

**1** Lower

**2** Raise

Place a rag under the jack handle extension to protect the bumper.

5-2. Steps to take in an emergency

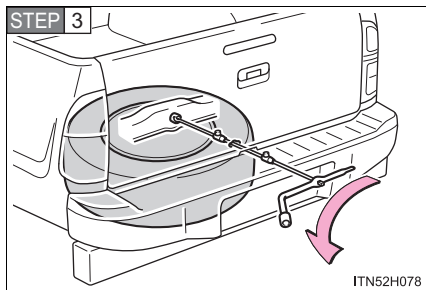

Lower the spare tire completely to the ground.

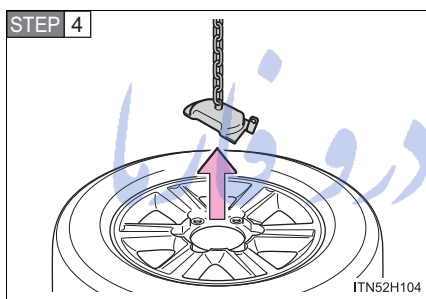

Remove the holding bracket and pull out the spare tire.

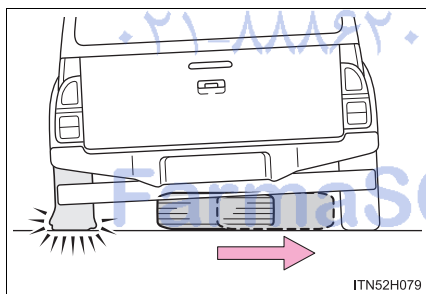

If it is difficult to pull the tire away from the vehicle, hold the tire and move it away from the flat tire, as shown in the illustration.

5

When trouble arises

## 5-2. Steps to take in an emergency

### Replacing a flat tire

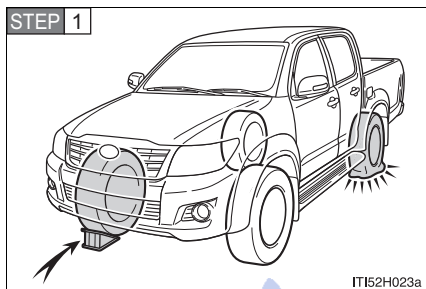

Chock the tires.

	Flat tire	Wheel chock positions
Front	Left-hand side	Behind the rear right-hand side tire
	Right-hand side	Behind the rear left-hand side tire
Rear	Left-hand side	In front of the front right-hand side tire
	Right-hand side	In front of the front left-hand side tire

تلفن شبانه روزی: ۰۲۱-۸۸۸۲۰۸۵

FarmaSOS.com

**STEP 2** Remove the wheel ornament.

**Type A**

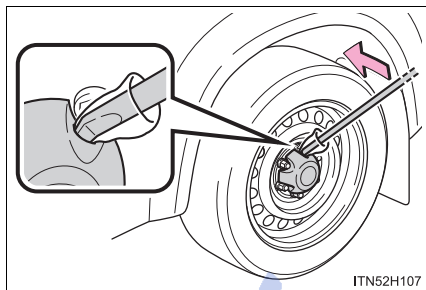

Pry off the wheel ornament, using the beveled end of the wheel nut wrench as shown.

To protect the wheel ornament, place a rag between the wheel nut wrench and the wheel ornament.

**Type B**

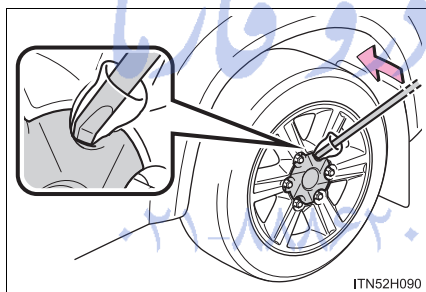

Pry off the wheel ornament, using the beveled end of the wheel nut wrench as shown.

To protect the wheel ornament, place a rag between the wheel nut wrench and the wheel ornament.

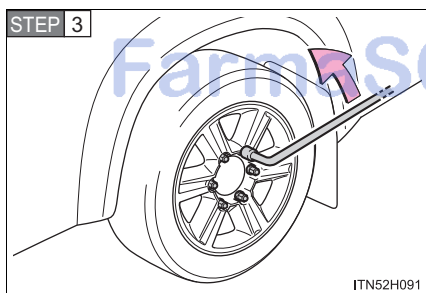

Slightly loosen the wheel nuts (one turn).

5-2. Steps to take in an emergency

**STEP 4** Assembling the jack handle. (→P. 570)

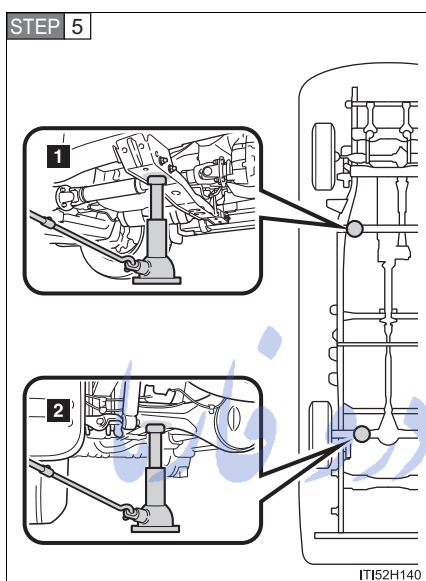

Position the jack at the jack points as shown.

**1** Front

Under the cross member

**2** Rear

Under the rear axle housing

تلفن شبانه روزی: ۰۲۱-۸۸۶۲۰۸۵

FarmaSOS.com

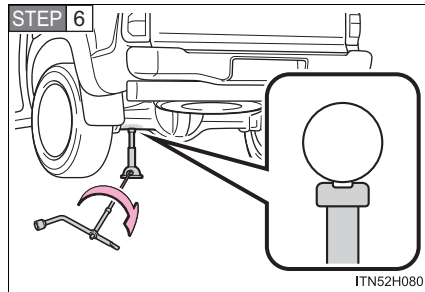

Raise the vehicle until the tire is slightly raised off the ground.

When positioning the jack under the rear axle housing, make sure the groove on the top of the jack fits with the rear axle housing.

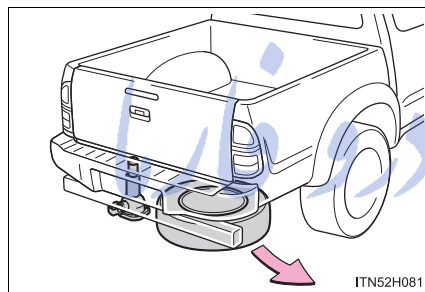

If the tire is still underneath the vehicle, leave the vehicle jacked up and use a tool to pull the tire out.

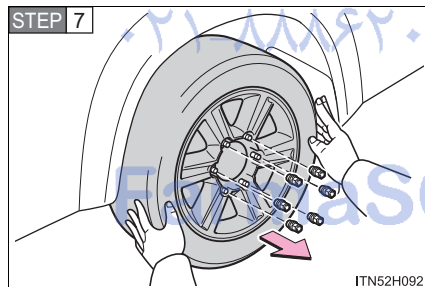

Remove all the wheel nuts and the tire.

When resting the tire on the ground, place the tire so that the wheel design faces up to avoid scratching the wheel surface.

**⚠ CAUTION**

**■ When take out the spare tire**

- Be careful not to touch the exhaust, as you may burn yourself.
- Be careful not to injure yourself by trapping your hands in or becoming caught in the rear under protection.

### Installing the spare tire

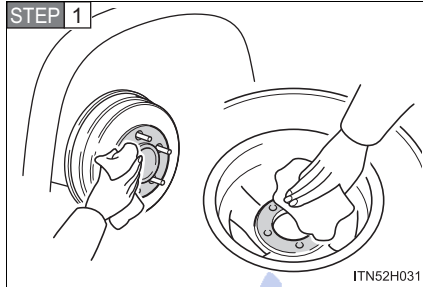

Remove any dirt or foreign matter from the wheel contact surface.

If foreign matter is on the wheel contact surface, the wheel nuts may loosen while the vehicle is in motion, causing the tire to come off.

**STEP 2** Install the tire and loosely tighten each wheel nut by hand by approximately the same amount.

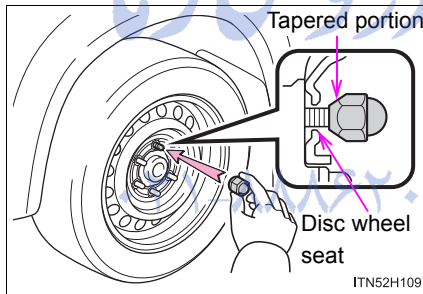

When replacing a steel wheel with a steel wheel, tighten the wheel nuts until the tapered portion comes into loose contact with the disc wheel seat.

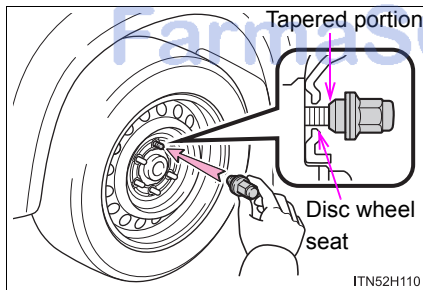

When replacing an aluminum wheel with a steel wheel, tighten the wheel nuts until the tapered portion comes into loose contact with the disc wheel seat.



5-2. Steps to take in an emergency

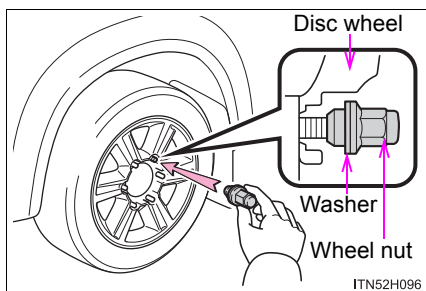

When replacing an aluminum wheel with an aluminum wheel, turn the wheel nuts until the washers come into contact with the disc wheel.

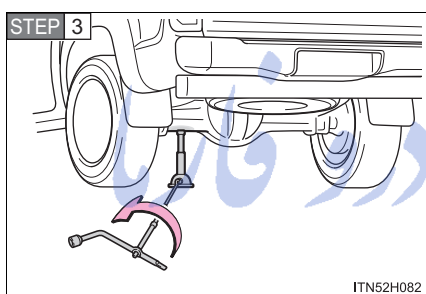

Lower the vehicle.

تلفن شبانه روزی: ۰۲۱-۸۸۶۲۰۸۵

FarmaSOS.com

## 5-2. Steps to take in an emergency

**STEP 4** Firmly tighten each wheel nut two or three times in the order shown in the illustration.

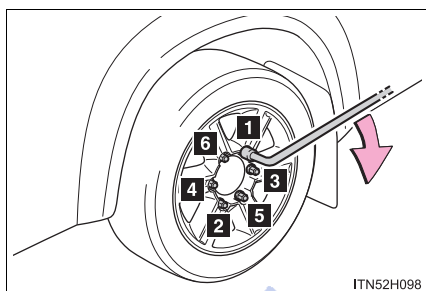

**Tightening torque:**

105 N•m (10.7 kgf•m, 77 ft•lbf)

**STEP 5** Vehicles with spare tire of the same wheel type as the installed tires: Reinstall the wheel ornament.

**Type A**

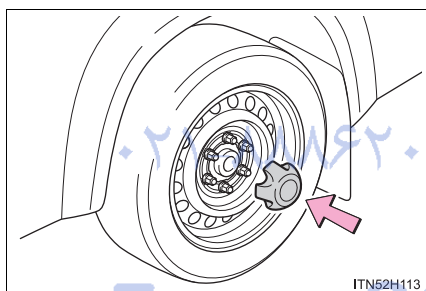

**Type B**

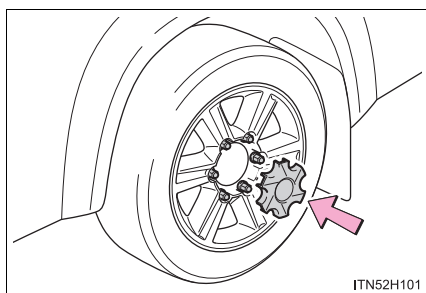

**Stowing the flat tire, jack and all tools**

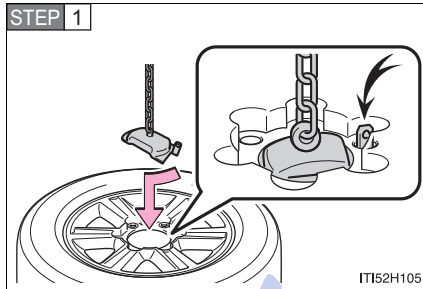

Lay down the tire with the outer side facing up, and hook the holding bracket as shown in the illustration.

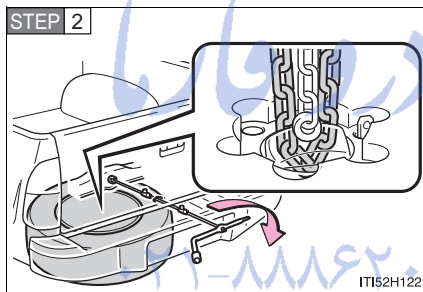

Raise the tire.

After the tire goes half way up, check that the suspended chain is able to enter the tire hole, for proper storage.

Check the tire from the side to see that the tire is stored horizontally.

**STEP 3** Stow the tools and jack securely.

FarmaSOS.com

## 5-2. Steps to take in an emergency

### ■ Certification for the jack



#### Manufacturer's Declaration of Conformity

1 April 2011

Aoyama Thai Co.,Ltd.  
64/49 Mu 4 Eastern Seaboard Industrial Estate  
Phuakdaeng , Rayong 21140

EU Representative

The EU Directives Covered by this Declaration  
2006/42/EC Machinery

The product covered

Model :  
- Jack Sub-Assy , Screw 1.5 Tons and 2.0 Tons  
- Jack Sub-Assy , Pantograph 1.0 Ton

The basis on which conformity is being declared

The Product Identified CE mark have to comply with the Requirement of the Machinery above by following standard  
ISO9001 / JIS D8103

The Technical documentation required to demonstrate the product meet the Machinery's requirement  
has been compiled by the signatory below and is available for inspection by the relevant enforcement authorities

The sample of the product has been tested by Manufacturer

Technical File Reference No. : EN01/2011

- Evaluation Test Report Jack Sub-Assy , Screw 1.5 Tons and 2.0 Tons  
- Evaluation Test Report Jack Sub-Assy , Pantograph 1.0 Ton

Yours Faithfully

Mr. Katsumi Buma  
Managing Director

สำนักงานใหญ่ (Head Office)

64/49 หมู่ 4 ตำบลอุตสาหกรรมสีหิงค์พื้นที่นิคมอุตสาหกรรม, ปากน้ำแดง อ. ระยอง 21140 โทร. : 038-955528-30, 038-959128-140 แฟกซ์ : 038-955531 , 038-959141-2  
64/49 Mu 4 Eastern Seaboard Industrial Estate Phuakdaeng Rayong 21140 Tel. : 038-955528-30, 038-959128-140 Fax . 038-955531 , 038-959141-2

**⚠ CAUTION**

■ **Using the tire jack**

Improper use of the tire jack may cause the vehicle to suddenly fall off the jack, leading to death or serious injury.

- Do not use the tire jack for any purpose other than replacing tires or installing and removing tire chains.
- Only use the tire jack that comes with this vehicle for replacing a flat tire. Do not use it on other vehicles, and do not use other tire jacks for replacing tires on this vehicle.
- Always check that the tire jack is securely set to the correct jack up point.
- Do not put any part of your body under the vehicle while it is supported by the jack.
- Do not start or run the engine while your vehicle is supported by the jack.
- Do not raise the vehicle while someone is inside.
- When raising the vehicle, do not put an object on or under the jack.
- Do not raise the vehicle to a height greater than that required to replace the tire.

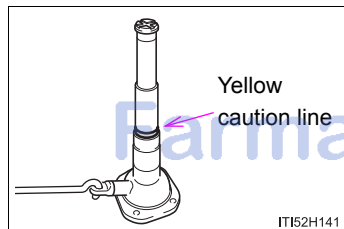

- Do not continue jacking up once the yellow caution line has appeared.

- Use a jack stand if it is necessary to get under the vehicle.

Take particular care when lowering the vehicle to ensure that no one working on or near the vehicle may be injured.

 CAUTION

■ **Using the jack handle**

Tighten all the jack handle bolts securely using a Phillips-head screwdriver or your hand, to prevent the extension parts from coming apart unexpectedly.

■ **Replacing a flat tire**

Observe the following precautions to reduce the risk of death or serious injury:

- Do not touch the disc wheels or the area around the brakes immediately after the vehicle has been driven.  
After the vehicle has been driven the disc wheels and the area around the brakes will be extremely hot. Touching these areas with hands, feet or other body parts while changing a tire, etc. may result in burns.
- Lower the spare tire completely to the ground before removing it from under the vehicle.
- Do not try to remove the wheel ornament by hand. Take due care in handling the ornament to avoid unexpected personal injury.
- Have the wheel nuts tightened with a torque wrench to 105 N•m (10.7 kgf•m, 77 ft•lbf) as soon as possible after changing wheels.
- Do not attach a heavily damaged wheel ornament, as it may fly off the wheel while the vehicle is moving.
- When installing a tire, only use wheel nuts that have been specifically designed for that wheel.
- If there are any cracks or deformations in the bolt screws, nut threads or bolt holes of the wheel, have the vehicle inspected by any authorized Toyota dealer or repairer, or another duly qualified and equipped professional.

Failure to follow these precautions could cause the wheel nuts to loosen and the tire to fall off, resulting in death or serious injury.

 CAUTION

■ **When installing the wheel nuts**

Be sure to install the wheel nuts with the tapered end facing inward.  
(→P. 510)

■ **After using the tools and jack**

Before driving, make sure all the tools and jack are securely in place in their storage location to reduce the possibility of personal injury during a collision or sudden braking.

 NOTICE

■ **Do not drive the vehicle with a flat tire.**

Do not continue driving with a flat tire.  
Driving even a short distance with a flat tire can damage the tire and the wheel beyond repair.

■ **When stowing the flat tire**

Ensure that there is no object caught between the tire and the vehicle underbody.

■ **When assembling the jack handle extension**

Tighten all the joints securely. Otherwise the extension may come off and it may damage the paint or vehicle body.

## 5-2. Steps to take in an emergency If the engine will not start

If the engine will not start even though correct starting procedures are being followed (→P. 162), consider each of the following points:

■ **The engine will not start even though the starter motor operates normally.**

One of the following may be the cause of the problem:

- There may not be sufficient fuel in the vehicle's tank. (→P. 595)
- There may be a malfunction in the engine immobilizer system. (→P. 102)

■ **The starter motor turns over slowly, the interior lights and headlights are dim, or the horn does not sound or sounds at a low volume.**

One of the following may be the cause of the problem:

- The battery may be discharged. (→P. 587)
- The battery terminal connections may be loose or corroded.

■ **The starter motor does not turn over, the interior lights and headlights do not turn on, or the horn does not sound.**

One of the following may be the cause of the problem:

- One or both of the battery terminals may be disconnected.
- The battery may be discharged. (→P. 587)

Contact any authorized Toyota dealer or repairer, or another duly qualified and equipped professional, if the problem cannot be repaired, or if repair procedures are unknown.



## 5-2. Steps to take in an emergency

### If the shift lever cannot be shifted from P\*

If the shift lever cannot be shifted with your foot on the brake pedal, there may be a problem with the shift lock system (a system to prevent accidental operation of the shift lever). Have the vehicle inspected by any authorized Toyota dealer or repairer, or another duly qualified and equipped professional immediately.

The following steps may be used as an emergency measure to ensure that the shift lever can be shifted:

**STEP 1** Set the parking brake.

**STEP 2** Turn the engine switch to the "ACC" position.

**STEP 3** Depress the brake pedal.

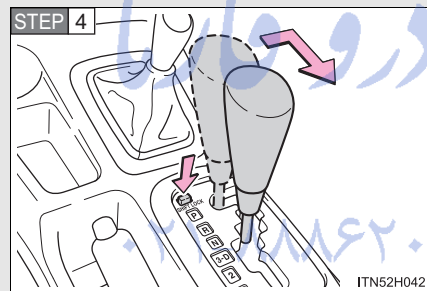

Press the shift lock override button.

The shift lever can be shifted while the button is pressed.

FarmaSOS.com

5

When trouble arises

\*: If equipped

585

## 5-2. Steps to take in an emergency If you lose your keys

New genuine keys can be made by any authorized Toyota dealer or repairer, or another duly qualified and equipped professional. Bring a master key and the key number stamped on the key number plate.

امداد خودرو فارما

تلفن شبانه روزی: ۰۲۱-۸۸۸۶۲۰۸۵

FarmaSOS.com

## 5-2. Steps to take in an emergency If the vehicle battery is discharged

The following procedures may be used to start the engine if the vehicle's battery is discharged.

You can also call any authorized Toyota dealer or repairer, or another duly qualified and equipped professional.

If you have a set of jumper (or booster) cables and a second vehicle with a 12-volt battery, you can jump start your vehicle by following the steps below.

**STEP 1** Connect the jumper cables according to the following procedure:

### 1KD-FTV engine

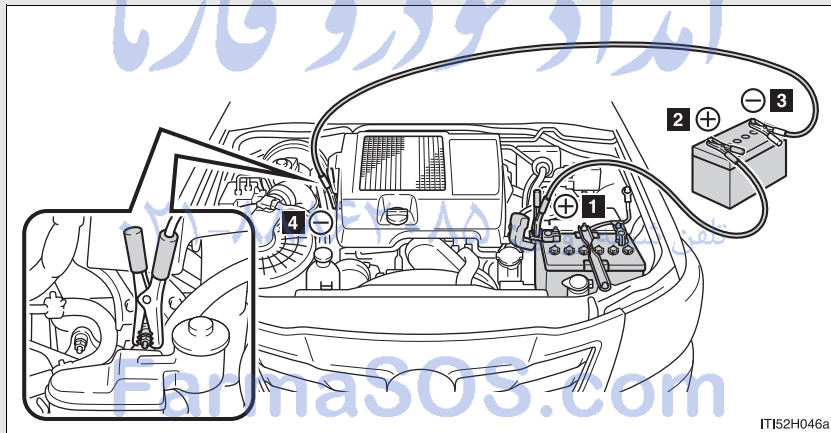

5

When trouble arises

## 5-2. Steps to take in an emergency

### 2KD-FTV engine

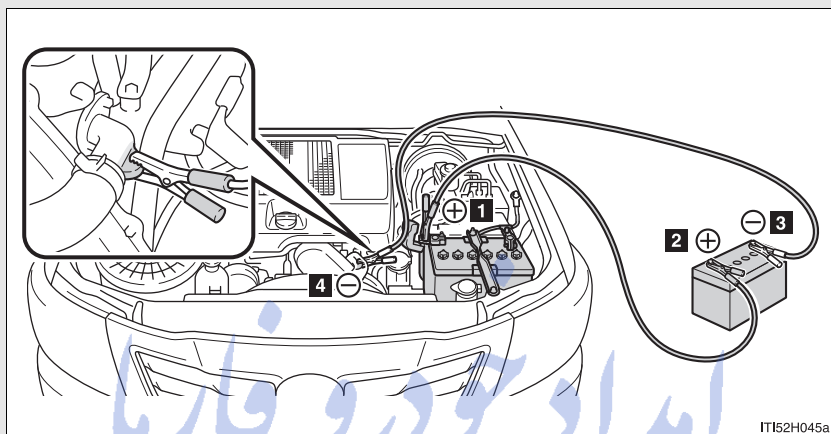

- 1** Connect a positive jumper cable clamp to the positive (+) battery terminal on your vehicle.
- 2** Connect the clamp on the other end of the positive cable to the positive (+) battery terminal on the second vehicle.
- 3** Connect a negative cable clamp to the negative (-) battery terminal on the second vehicle.
- 4** Connect the clamp at the other end of the negative cable to a solid, stationary, unpainted metallic point away from the battery and any moving parts, as shown in the illustration.

**STEP 2** Start the engine of the second vehicle. Increase the engine speed slightly and maintain at that level for approximately 5 minutes to recharge the battery of your vehicle.

**STEP 3** Maintain the engine speed of the second vehicle and start the engine of your vehicle.

**STEP 4** Once the vehicle's engine has started, remove the jumper cables in the exact reverse order from which they were connected.

Once the engine starts, have the vehicle inspected at any authorized Toyota dealer or repairer, or another duly qualified and equipped professional, as soon as possible.

■ **Starting the engine when the battery is discharged (vehicles with automatic transmission)**

The engine cannot be started by push-starting.

■ **To prevent battery discharge**

- Turn off the headlights and the audio system while the engine is off.
- Turn off any unnecessary electrical components when the vehicle is running at a low speed for an extended period, such as in heavy traffic.

■ **When the battery is removed or discharged**

The power windows must be initialized. (→P. 92)

■ **Charging the battery**

The electricity stored in the battery will discharge gradually even when the vehicle is not in use, due to natural discharge and the draining effects of certain electrical appliances. If the vehicle is left for a long time, the battery may discharge, and the engine may be unable to start. (The battery recharges automatically during driving.)

 CAUTION

■ **Avoiding battery fires or explosions**

Observe the following precautions to prevent accidentally igniting the flammable gas that may be emitted from the battery:

- Make sure each jumper cable is connected to the correct terminal and that it is not unintentionally in contact with any other than the intended terminal.
- Do not allow the + and - clamps of the jumper cables to come into contact with each other.
- Do not smoke, use matches, cigarette lighters or allow open flame near the battery.

■ **Battery precautions**

The battery contains poisonous and corrosive acidic electrolyte, while related parts contain lead and lead compounds. Observe the following precautions when handling the battery:

- When working with the battery, always wear safety glasses and take care not to allow any battery fluids (acid) to come into contact with skin, clothing or the vehicle body.
- Do not lean over the battery.
- In the event that battery fluid comes into contact with the skin or eyes, immediately wash the affected area with water and seek medical attention. Place a wet sponge or cloth over the affected area until medical attention can be received.
- Always wash your hands after handling the battery support, terminals, and other battery-related parts.
- Do not allow children near the battery.

■ **To prevent damage to the vehicle**

Do not pull- or push-start the vehicle as the catalytic converter may overheat and become a fire hazard.

 NOTICE

■ **When handling jumper cables**

When connecting the jumper cables, ensure that they do not become entangled in the cooling fan or belt.

امداد خودرو فارما

تلفن شبانه روزی: ۰۲۱-۸۸۸۶۲۰۸۵

FarmaSOS.com

## 5-2. Steps to take in an emergency If your vehicle overheats

If your engine overheats:

**STEP 1** Stop the vehicle in a safe place and turn off the air conditioning system.

**STEP 2** Check to see if steam is coming out from under the hood.

If you see steam:

Stop the engine. Carefully lift the hood after the steam subsides and then restart the engine.

If you do not see steam:

Leave the engine running and carefully lift the hood.

**STEP 3** Check to see if the cooling fan is operating.

If the fan is operating:

Wait until the temperature of the engine (shown on the instrument panel) begins to fall and then stop the engine.

If the fan is not operating:

Stop the engine immediately and call any authorized Toyota dealer or repairer, or another duly qualified and equipped professional.

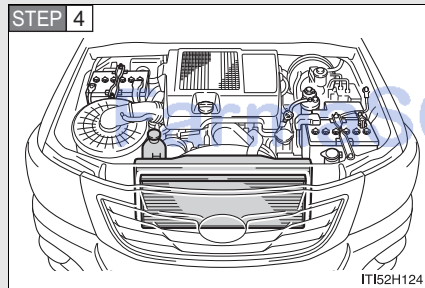

After the engine has cooled down sufficiently, check the engine coolant level and inspect the radiator core (radiator) for any leaks.



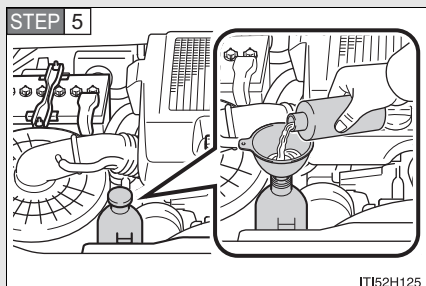

Add engine coolant if necessary.

Water can be used in an emergency if engine coolant is unavailable. (→P. 614)

Have the vehicle inspected at the nearest authorized Toyota dealer or repairer, or another duly qualified and equipped professional as soon as possible.

#### ■ Overheating

If you observe the following, your vehicle may be overheating:

- The engine coolant temperature gauge enters the red zone or a loss of power is experienced.
- Steam comes out from under the hood.

FarmaSOS.com

 CAUTION

■ **To prevent an accident or injury when inspecting under the hood of your vehicle**

- If steam is seen coming from under the hood, do not open the hood until the steam has subsided. The engine compartment may be very hot, causing serious injuries such as burns.
- Keep hands and clothing away from the fans and drive belt while the engine is running.
- Do not loosen the coolant reservoir cap while the engine and radiator are hot.  
Serious injury, such as burns, may result from hot coolant and steam released under pressure.

 NOTICE

■ **When adding engine coolant**

Wait until the engine has cooled down before adding engine coolant. When adding coolant, do so slowly. Adding cool coolant to a hot engine too quickly can cause damage to the engine.

FarmaSOS.com

## 5-2. Steps to take in an emergency

### If you run out of fuel and the engine stalls

If you run out of fuel and the engine stalls:

**STEP 1** Refuel your vehicle.

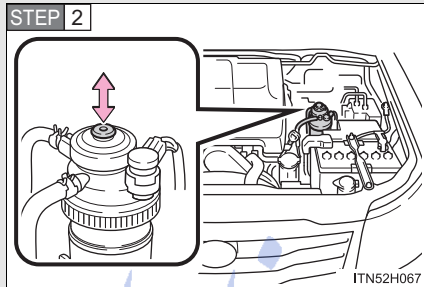

To bleed the fuel system, operate the priming pump until you feel more resistance.

**STEP 3** Start the engine. (→P. 162)

If the engine does not start after the above steps have been performed, wait for 10 seconds and try step 2 and 3 again. If the engine still does not start, contact any authorized Toyota dealer or repairer, or another duly qualified and equipped professional.

After starting the engine, depress the accelerator pedal lightly until the engine runs smoothly.

#### NOTICE

##### ■ When restarting the engine

- Do not crank the engine before refueling and operating the priming pump. This may damage the engine and fuel system.
- Do not crank the engine for more than 30 seconds at a time. This may overheat the starter and wiring system.

5

When trouble arises

## 5-2. Steps to take in an emergency If the vehicle becomes stuck

Carry out the following procedures if the tires spin or the vehicle becomes stuck in mud, dirt or snow:

**STEP 1** Stop the engine. Set the parking brake and shift the shift lever to P (automatic transmission) or N (manual transmission).

**STEP 2** Remove the mud, snow or sand from around the stuck tire.

**STEP 3** Place wood, stones or some other material under the tires to help provide traction.

**STEP 4** Restart the engine.

**STEP 5** Lock the rear differential. (→P. 217)

**STEP 6** Shift the shift lever to the D or R position (automatic transmission) or 1 or R position (manual transmission) and carefully apply the accelerator to free the vehicle.

For vehicles with VSC system, turn off TRC and VSC if these functions are hampering your attempts to free the vehicle.  
(→P. 222)

تلفن شبانه روزی: ۰۲۱-۸۸۶۲۰۸۵

### CAUTION

#### ■ When attempting to free a stuck vehicle

If you choose to push the vehicle back and forth to free it, make sure the surrounding area is clear to avoid striking other vehicles, objects or people. The vehicle may also lunge forward or lunge back suddenly as it becomes free. Use extreme caution.

#### ■ When shifting the shift lever

For vehicles with automatic transmission, be careful not to shift the shift lever with the accelerator pedal depressed. This may lead to unexpected rapid acceleration of the vehicle that may cause an accident resulting in death or serious injury.

 NOTICE

■ **To avoid damage to the transmission and other components**

- Avoid spinning the wheels and depressing the accelerator pedal more than necessary.
- If the vehicle remains stuck even after these procedures are performed, the vehicle may require towing to be freed.

امداد خودرو فارما

تلفن شبانه روزی: ۰۲۱-۸۸۸۶۲۰۸۵

FarmaSOS.com

## 5-2. Steps to take in an emergency

### If your vehicle has to be stopped in an emergency

Only in an emergency, such as if it becomes impossible to stop the vehicle in the normal way, stop the vehicle using the following procedure:

**STEP 1** Steadily step on the brake pedal with both feet and firmly depress it.

Do not pump the brake pedal repeatedly as this will increase the effort required to slow the vehicle.

**STEP 2** Shift the shift lever to N.

#### If the shift lever is shifted to N

**STEP 3** After slowing down, stop the vehicle in a safe place by the road.

**STEP 4** Stop the engine.

#### If the shift lever cannot be shifted to N

**STEP 3** Keep depressing the brake pedal with both feet to reduce vehicle speed as much as possible.

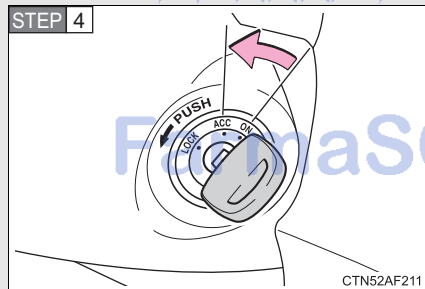

Stop the engine by turning the engine switch to the “ACC” position.

**STEP 5** Stop the vehicle in a safe place by the road.

 CAUTION

■ **If the engine has to be turned off while driving**

- Power assist for the brakes and steering wheel will be lost, making the brake pedal harder to depress and the steering wheel heavier to turn. Decelerate as much as possible before turning off the engine.
- Never attempt to remove the key, as doing so will lock the steering wheel.

امداد خودرو فارما

تلفن شبانه روزی: ۰۲۱-۸۸۸۶۲۰۸۵

FarmaSOS.com

امداد خودرو فارما

تلفن شبانه روزی: ۰۲۱-۸۸۸۶۲۰۸۵

**FarmaSOS.com**



## Vehicle specifications

# 6

### 6-1. Specifications

Maintenance data (fuel, oil level, etc.).....	600
Fuel information .....	621

### 6-2. Initialization

Items to initialize .....	623
---------------------------	-----

تلفن شبانه روزی: ۰۲۱-۸۸۸۶۲۰۸۵

FarmaSOS.com

## 6-1. Specifications

### Maintenance data (fuel, oil level, etc.)

#### Dimensions

Overall length		5135 mm (202.1 in.) <sup>*2</sup> 5260 mm (207.0 in.) <sup>*3</sup>
Overall width		1760 mm (69.3 in.) <sup>*4</sup> 1835 mm (72.2 in.) <sup>*5</sup>
Overall height <sup>*1</sup>	Single-cab models	1795 mm (70.7 in.) <sup>*6, 7</sup> 1805 mm (71.0 in.) <sup>*8</sup>
	Extra-cab models	1835 mm (72.2 in.)
	Double-cab models	1850 mm (72.8 in.) <sup>*6, 7</sup> 1860 mm (73.2 in.) <sup>*8</sup>
Wheelbase		3085 mm (121.5 in.)
Front and rear tread		1510 mm (59.4 in.) <sup>*6</sup> 1540 mm (60.6 in.) <sup>*7, 8</sup>

\*1: Unladen vehicle

\*2: Without rear bumper

\*3: With rear bumper

\*4: Without over fender

\*5: With over fender

\*6: With 205R16C tires

\*7: With 255/70R15C tires

\*8: With 265/65R17 tires

**Weights****Single-cab models**

Gross vehicle mass	4WD models	Left-hand drive vehicles	2640 kg (5820 lb.)
		Right-hand drive vehicles	2730 kg (6019 lb.)
	Pre Runner		2640 kg (5820 lb.)
Maximum permissible axle capacity	Front		1280 kg (2822 lb.)
	Rear		1600 kg (3527 lb.)
Drawbar load			115 kg (254 lb.)
Towing capacity	Without brake		750 kg (1654 lb.)
	With brake		2800 kg (6173 lb.)

تلفن شبانه روزی: ۰۲۱-۸۸۶۲۰۸۵

FarmaSOS.com

## 6-1. Specifications

### Extra-cab models

Gross vehicle mass	4WD models	Left-hand drive vehicles	2620 kg (5776 lb.)* <sup>1</sup> 2705 kg (5964 lb.)* <sup>2</sup>
		Right-hand drive vehicles	3010 kg (6636 lb.)
	Pre Runner		2590 kg (5710 lb.)
Maximum permissible axle capacity	Front		1280 kg (2822 lb.)
	Rear	Left-hand drive vehicles	1600 kg (3527 lb.)
		Right-hand drive vehicles	1600 kg (3527 lb.)* <sup>3</sup> 1900 kg (4189 lb.)* <sup>4</sup>
Drawbar load		115 kg (254 lb.)	
Towing capacity	Without brake		750 kg (1654 lb.)
	With brake		2800 kg (6173 lb.)

\*1: Models for European countries\*<sup>5</sup>

\*2: Models only for Finland\*<sup>5</sup> تلفن شبانه روزی: ۰۸۵ + ۰۶۲۰۱۱۱۱۱۱

\*3: Pre Runner

\*4: 4WD models

\*5: See "Checking your vehicle's model" if you are not sure of which model your vehicle is. (→P. 41)

FarmaSOS.com

**Double-cab models**

Gross vehicle mass	4WD models	1KD-FTV engine	Left-hand drive vehicles	2720 kg (5967 lb.)* <sup>1</sup> 2730 kg (6019 lb.)* <sup>2</sup>
			Right-hand drive vehicles	3080 kg (6790 lb.)
		2KD-FTV engine	Left-hand drive vehicles	2680 kg (5908 lb.)* <sup>1</sup> 2690 kg (5930 lb.)* <sup>2</sup>
			Right-hand drive vehicles	3040 kg (6702 lb.)
	Pre Runner	2600 kg (5732 lb.)		
Maximum permissible axle capacity	1KD-FTV engine	Left-hand drive vehicles	Front	1340 kg (2954 lb.)
			Rear	1600 kg (3527 lb.)
		Right-hand drive vehicles	Front	1340 kg (2954 lb.)
			Rear	1900 kg (4189 lb.)
	2KD-FTV engine	Left-hand drive vehicles	Front	1280 kg (2822 lb.)
			Rear	1600 kg (3527 lb.)
		Right-hand drive vehicles	Front	1280 kg (2822 lb.)
			Rear	1600 kg (3527 lb.)* <sup>3</sup> 1900 kg (4189 lb.)* <sup>4</sup>
Drawbar load				115 kg (254 lb.)
Towing capacity	Without brake			750 kg (1654 lb.)
	With brake			2790 kg (6151 lb.)* <sup>5</sup> 2800 kg (6173 lb.)* <sup>6</sup>

## 6-1. Specifications

- \*1: For Norway
- \*2: Except for Norway
- \*3: Pre Runner
- \*4: 4WD models
- \*5: KUN26L-PRMDYW and KUN26L-PRADYW models\*<sup>7</sup>
- \*6: Except KUN26L-PRMDYW and KUN26L-PRADYW models\*<sup>7</sup>
- \*7: The model code is indicated on the manufacturer's label or plate.  
(→P. 606)

### Vehicle identification

#### ■ Vehicle identification number

The vehicle identification number (VIN) is the legal identifier for your vehicle. This is the primary identification number for your Toyota. It is used in registering the ownership of your vehicle.

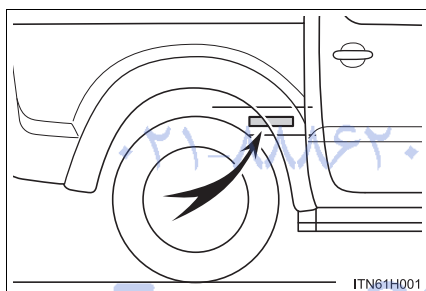

This number is stamped on the rear right frame.

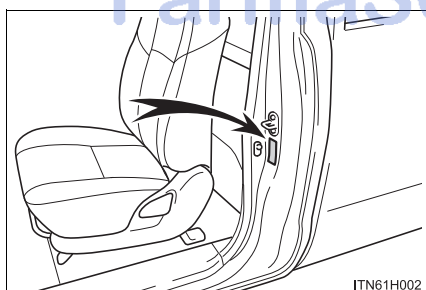

This number is also on the manufacturer's label or plate.

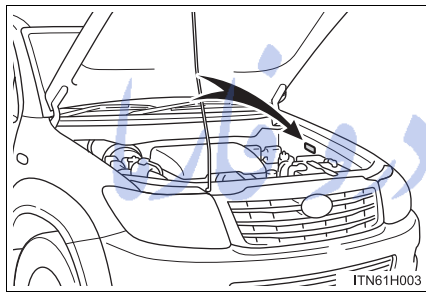
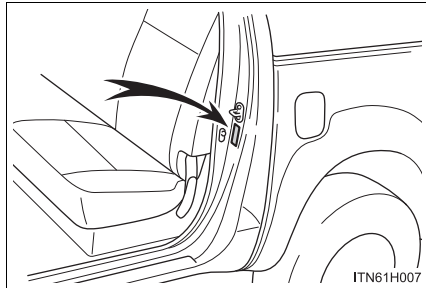

■ **Engine number**

The engine number is stamped on the engine block as shown.

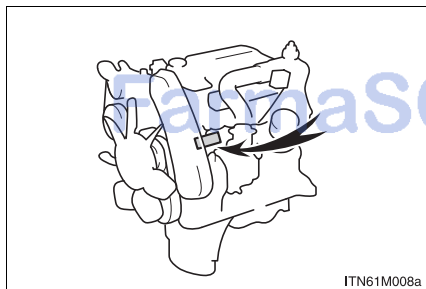

**Engine****1KD-FTV engine**

Model	1KD-FTV
Type	4 cylinder in line, 4 cycle, diesel (with turbo-charger)
Bore and stroke	96.0 × 103.0 mm (3.78 × 4.06 in.)
Displacement	2982 cm <sup>3</sup> (182.0 cu.in.)
Valve clearance (engine cold)	Intake: 0.20 — 0.30 mm (0.008 — 0.012 in.) Exhaust: 0.35 — 0.45 mm (0.014 — 0.018 in.)
Drive belt tension	Automatic adjustment

**2KD-FTV engine**

Model	2KD-FTV
Type	4 cylinder in line, 4 cycle, diesel (with turbo-charger)
Bore and stroke	92.0 × 93.8 mm (3.62 × 3.69 in.)
Displacement	2494 cm <sup>3</sup> (152.2 cu.in.)
Valve clearance (engine cold)	Intake: 0.20 — 0.30 mm (0.008 — 0.012 in.) Exhaust: 0.35 — 0.45 mm (0.014 — 0.018 in.)
Drive belt tension	Automatic adjustment



**Fuel**

Fuel type	EU area: Diesel fuel conforming to European standard EN590 Except EU area (except Russia): Diesel fuel that contains 50 ppm or less of sulfur Except EU area (Russia): Diesel fuel conforming to GOST R52368-2005 (Sulfur max 50 ppm).
Cetane number	48 or higher
Fuel tank capacity (Reference)	80 L (21.1 gal., 17.6 Imp.gal.)

تلفن شبانه روزی: ۰۲۱-۸۸۸۶۲۰۸۵

FarmaSOS.com

## 6-1. Specifications

### Lubrication system (except for Russia and Ukraine)

Oil capacity (Drain and refill — reference*)	
With filter	6.9 L (7.3 qt., 6.1 Imp.qt.)
Without filter	6.6 L (7.0 qt., 5.8 Imp.qt.)

\*: The engine oil capacity is a reference quantity to be used when changing the engine oil. Warm up and turn off the engine, wait more than 5 minutes, and check the oil level on the dipstick.

#### ■ Engine oil selection

“Toyota Genuine Motor Oil” is used in your Toyota vehicle. Toyota recommends the use of approved “Toyota Genuine Motor Oil”. Another motor oil of matching quality can also be used.

Oil grade: ACEA C2

#### NOTICE

Using engine oil other than ACEA C2 may damage the catalytic converter.

FarmaSOS.com

## Recommended viscosity (SAE):

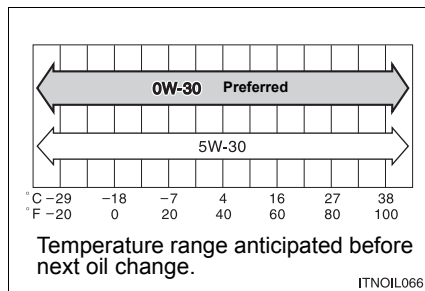

SAE 0W-30 is filled into your Toyota vehicle at manufacturing, and the best choice for good fuel economy and good starting in cold weather.

Oil viscosity (0W-30 is explained here as an example):

- The 0W in 0W-30 indicates the characteristic of the oil which allows cold startability. Oils with a lower value before the W allow for easier starting of the engine in cold weather.
- The 30 in 0W-30 indicates the viscosity characteristic of the oil when the oil is at high temperature. An oil with a higher viscosity (one with a higher value) may be better suited if the vehicle is operated at high speeds, or under extreme load conditions.

FarmaSOS.com

**Lubrication system (for Russia and Ukraine)**

Oil capacity (Drain and refill — reference*)	
With filter	6.9 L (7.3 qt., 6.1 Imp.qt.)
Without filter	6.6 L (7.0 qt., 5.8 Imp.qt.)

\*: The engine oil capacity is a reference quantity to be used when changing the engine oil. Warm up and turn off the engine, wait more than 5 minutes, and check the oil level on the dipstick.

**■ Engine oil selection**

“Toyota Genuine Motor Oil” is used in your Toyota vehicle. Toyota recommends the use of approved “Toyota Genuine Motor Oil”. Another motor oil of matching quality can also be used.

Oil grade: ACEA B1, API CF-4 or CF  
(You may also use API CE or CD.)

تلفن شبانه روزی: ۰۲۱-۸۸۶۲۰۸۵

FarmaSOS.com

## Recommended viscosity (SAE):

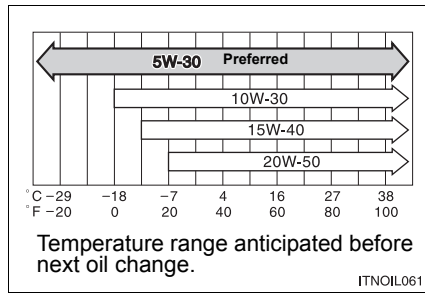

SAE 5W-30 is filled into your Toyota vehicle at manufacturing, and the best choice for good fuel economy and good starting in cold weather.

If you use SAE 10W-30 or a higher viscosity engine oil in extremely low temperatures, the engine may become difficult to start, so SAE 5W-30 engine oil is recommended.

Oil viscosity (5W-30 is explained here as an example):

- The 5W in 5W-30 indicates the characteristic of the oil which allows cold startability. Oils with a lower value before the W allow for easier starting of the engine in cold weather.
- The 30 in 5W-30 indicates the viscosity characteristic of the oil when the oil is at high temperature. An oil with a higher viscosity (one with a higher value) may be better suited if the vehicle is operated at high speeds, or under extreme load conditions.

FarmaSOS.com

## 6-1. Specifications

### Cooling system

Capacity	With manual transmission	9.8 L (10.4 qt., 8.6 Imp.qt.)
	With automatic transmission	11.1 L (11.7 qt., 9.8 Imp.qt.)
Coolant type	Use either of the following: <ul style="list-style-type: none"><li>• “Toyota Super Long Life Coolant”</li><li>• Similar high-quality ethylene glycol-based non-silicate, non-amine, non-nitrite, and non-borate coolant with long-life hybrid organic acid technology</li></ul> Do not use plain water alone.	

تلفن شبانه روزی: ۰۲۱-۸۸۸۶۲۰۸۵

FarmaSOS.com

**Electrical system**

Battery	
Specific gravity reading at 20°C (68°F):	1.250 — 1.290 Fully charged 1.160 — 1.200 Half charged 1.060 — 1.100 Discharged
Charging rates	
Quick charge	15 A max.
Slow charge	5 A max.

**Automatic transmission**

Fluid capacity*	10.6 L (11.2 qt., 9.3 Imp.qt.)
Fluid type	Toyota Genuine ATF WS

\*: The fluid capacity is the quantity of reference.  
If replacement is necessary, contact any authorized Toyota dealer or repairer, or another duly qualified and equipped professional.

**⚠ NOTICE****■ Automatic transmission fluid type**

Using transmission fluid other than “Toyota Genuine ATF WS” may cause deterioration in shift quality, locking up of your transmission accompanied by vibration, and ultimately damage the transmission of your vehicle.

## 6-1. Specifications

### Manual transmission

Oil capacity	4WD models	2.2 L (2.3 qt., 1.9 Imp.qt.)
	Pre Runner	2.6 L (2.7 qt., 2.3 Imp.qt.)
Oil type	Gear oil API GL-4 or GL-5	
Recommended oil viscosity	For Martinique, Israel, Guadeloupe and French Guiana SAE 75W-90, 80W or 80W-90 Others SAE 75W-90	

### Transfer

Oil capacity	1.0 L (1.1 qt., 0.9 Imp.qt.)
Oil type	Gear oil API GL-4 or GL-5
Recommended oil viscosity	SAE 75W-90

تلفن شبانه روزی: ۰۲۱-۸۸۶۲۰۸۵

FarmaSOS.com



**Differential**

Oil capacity	Front	Without A.D.D	1.45 L (1.53 qt., 1.28 Imp.qt.)
		With A.D.D	1.65 L (1.74 qt., 1.45 Imp.qt.)
	Rear	With rear differential lock system	2.90 L (3.06 qt., 2.55 Imp.qt.)
		With LSD	3.35 L (3.54 qt., 2.95 Imp.qt.)
		Normal	2.45 L (2.59 qt., 2.16 Imp.qt.) <sup>*1</sup> 3.35 L (3.54 qt., 2.95 Imp.qt.) <sup>*2</sup>
Oil type	Without LSD	Hypoid gear oil API GL-5	
	With LSD	Hypoid gear oil LSD API GL-5	
Oil viscosity	Without A.D.D.	Above -18°C (0°F): SAE90 Below -18°C (0°F): SAE 80W or SAE 80W-90	
	With A.D.D.	SAE75W-90	

\*1: Made in South Africa<sup>\*3</sup>

\*2: Made in Thailand<sup>\*3</sup>

\*3: See "Checking your vehicle's model" if you are not sure of which model your vehicle is. (→P. 41)

## 6-1. Specifications

### Clutch

Pedal free play	5 — 15 mm (0.2 — 0.6 in.)
Fluid type	SAE J1703 or FMVSS No.116 DOT 3 or SAE J1704 or FMVSS No.116 DOT 4

### Brakes

Pedal clearance*1	Left-hand drive vehicles	Without VSC	85 mm (3.3 in.)
		With VSC	79 mm (3.1 in.)
	Right-hand drive vehicles	Without VSC	89 mm (3.5 in.)
		With VSC	83 mm (3.3 in.)
Pedal free play			1.0 — 6.0 mm (0.04 — 0.24 in.)
Parking brake lever travel*2			7 — 9 clicks
Fluid type			SAE J1703 or FMVSS No.116 DOT 3 or SAE J1704 or FMVSS No.116 DOT 4

\*1: Minimum pedal clearance when depressed with a force of 490 N (50 kgf, 110 lbf) while the engine is running

\*2: Parking brake lever travel when pulled up with a force of 200 N (20.4 kgf, 45.0 lbf)

**Chassis lubrication**

Propeller shafts	Spider	Lithium base chassis grease, NLGI No.2
------------------	--------	--

**Steering**

Free play	Less than 30 mm (1.2 in.)
Power steering fluid type	Automatic transmission fluid DEXRON® II or III

امداد خودرو فارما

تلفن شبانه روزی: ۰۲۱-۸۸۸۶۲۰۸۵

FarmaSOS.com

## 6-1. Specifications

### Tires and wheels

#### 15 inch tires

Tire size	255/70R15C 112/110S		
Tire inflation pressure (Recommended cold tire inflation pressure)	Front wheel kPa (kgf/cm <sup>2</sup> or bar, psi)	Rear wheel (unloaded) kPa (kgf/cm <sup>2</sup> or bar, psi)	Rear wheel (loaded) kPa (kgf/cm <sup>2</sup> or bar, psi)
	Single-cab models	200 (2.0, 29)	200 (2.0, 29)
Extra-cab and double-cab models	200 (2.0, 29)	200 (2.0, 29)	250 (2.5, 36) <sup>*1</sup> 250 (2.5, 36) <sup>*2, 3</sup> 310 (3.1, 45) <sup>*2, 4</sup>
Wheel size	15 × 7JJ, 15 × 7J		
Wheel nut torque	105 N•m (10.7 kgf•m, 77 ft•lbf)		

#### 16 inch tires

Tire size	205R16C 8PR 110/108S		
Tire inflation pressure (Recommended cold tire inflation pressure)	Front wheel kPa (kgf/cm <sup>2</sup> or bar, psi)	Rear wheel (unloaded) kPa (kgf/cm <sup>2</sup> or bar, psi)	Rear wheel (loaded) kPa (kgf/cm <sup>2</sup> or bar, psi)
	Single-cab models	240 (2.4, 35)	240 (2.4, 35)
Extra-cab and double-cab models	240 (2.4, 35)	240 (2.4, 35)	320 (3.2, 46) <sup>*1</sup> 320 (3.2, 46) <sup>*2, 3</sup> 400 (4.0, 58) <sup>*2, 4</sup>
Wheel size	16 × 6J		
Wheel nut torque	105 N•m (10.7 kgf•m, 77 ft•lbf)		

**17 inch tires**

Tire size	265/65R17 112S
Tire inflation pressure (Recommended cold tire inflation pressure)	DLX grade models with 1KD-FTV engine 230 kPa (2.3 kgf/cm <sup>2</sup> or bar, 33 psi) SR grade models with 2KD-FTV engine Single-cab models 230 kPa (2.3 kgf/cm <sup>2</sup> or bar, 33 psi) Double-cab models 200 kPa (2.0 kgf/cm <sup>2</sup> or bar, 29 psi) Other models 200 kPa (2.0 kgf/cm <sup>2</sup> or bar, 29 psi)
Wheel size	17 × 7 1/2J
Wheel nut torque	105 N•m (10.7 kgf•m, 77 ft•lbf)

- \*1. Left-hand drive vehicles
- \*2. Right-hand drive vehicles
- \*3. Half loaded
- \*4. Full loaded

تلفن شبانه روزی: ۰۲۱-۸۸۶۲۰۸۵

FarmaSOS.com

## 6-1. Specifications

### Light bulbs

	Light Bulbs	W	Type
Exterior	Headlights	60/55	A
	Front fog lights*	19	B
	Front position lights	5	C
	Front turn signal lights	21	D
	Side turn signal lights	5	C
	Rear turn signal lights	21	E
	Back-up lights	21	F
	Rear fog lights*	21	F
	License plate lights	5	C
	Stop/tail lights	21/5	F
Interior	Interior light	8	G
	Personal lights	8	C

A: H4 halogen bulbs

B: H16LL halogen bulbs

C: Wedge base bulbs (clear)

D: Wedge base bulbs (amber)

E: Single end bulbs (amber)

F: Single end bulbs (clear)

G: Double end bulbs

\*: If equipped

## 6-1. Specifications

### Fuel information

#### EU area:

Your vehicle must use only diesel fuel conforming to European standard EN590.

#### Except EU area (except Russia):

Your vehicle must use only diesel fuel that contains 50 ppm or less of sulfur and has a cetane number of 48 or higher.

#### Except EU area (Russia):

You must only use diesel fuel with a cetane number of 48 or higher.

Your vehicle must use only diesel fuel confirming to GOST R52368-2005 (Sulfur max 50 ppm).

#### ■ If you plan to drive in foreign countries

Low sulfur diesel fuel may not be available, so please check the availability with your distributor.

#### ■ If your engine knocks

- Consult any authorized Toyota dealer or repairer, or another duly qualified and equipped professional.
- You may occasionally notice light knocking for a short time while accelerating or driving uphill. This is normal and there is no need for concern.

 NOTICE

■ **Notice on fuel quality**

- Do not use improper fuels. If improper fuels are used, the engine will be damaged.
- Diesel engine (EU area): FAME (Fatty Acid Methyl Ester) fuel sold under names such as “B30” or “B100” and fuel containing a large amount of FAME should not be used. The use of these fuels will damage the vehicle’s fuel system. In case of any doubt, ask any authorized Toyota dealer or repairer, or another duly qualified and equipped professional.
- Diesel engine (except EU area [except Russia]): FAME (Fatty Acid Methyl Ester) fuel sold under names such as “B30” or “B100” and fuel containing a large amount of FAME should not be used. Your vehicle can use diesel mixed with 5% max biodiesel FAME (B5). The use of fuel with more than 5% FAME content (B5) will damage the vehicle’s fuel system. You must ensure that refueling is carried out only from a source where fuel specification and quality can be guaranteed.  
In case of any doubt, ask any authorized Toyota dealer or repairer, or another duly qualified and equipped professional.
- Diesel engine (except EU area [Russia]): FAME (Fatty Acid Methyl Ester) fuel sold under name such as “B30” or “B100” and fuel containing a large amount of FAME should not be used.  
The use of these fuel will damage the vehicle’s fuel system. In case of any doubt, ask any authorized Toyota dealer or repairer, or another duly qualified and equipped professional.

■ **Notice on diesel fuel quality**

Do not use a fuel that contains more than 50 ppm of sulfur.  
Use of such a high sulfur fuel may damage the engine.



## 6-2. Initialization Items to initialize

The following items must be initialized for normal system operation after such cases as the battery is reconnected, or maintenance is performed on the vehicle.

Item	When to initialize	Reference
Power windows*	After reconnecting or changing the battery	P. 91
Engine oil maintenance data*	After changing engine oil	P. 491

\*: If equipped

امداد خودرو فارما  
تلفن شبانه روزی: ۰۲۱-۸۸۸۶۲۰۸۵

FarmaSOS.com

امداد خودرو فارما

تلفن شبانه روزی: ۰۲۱-۸۸۸۶۲۰۸۵

**FarmaSOS.com**

## Index

Abbreviation list ..... 628

Alphabetical index..... 629

What to do if... ..... 639

امداد خودرو فارما

تلفن شبانه روزی: ۰۲۱-۸۸۸۶۲۰۸۵

FarmaSOS.com

**Abbreviation list****Abbreviation/Acronym list**

ABBREVIATIONS	MEANING
4WD	4-Wheel Drive
A/C	Air Conditioning
ABS	Anti-lock Brake System
ACC	Accessory
ADD	Automatic Disconnecting Differential
AUX	Auxiliary
CRS	Child Restraint System
DISP	Display
DPF	Diesel Particulate Filter
ELR	Emergency Locking Retractor
GVM	Gross Vehicle Mass
LED	Light Emitting Diode
LSD	Limited Slip Differential
MPAC	Maximum Permissible Axle Capacity
SRS	Supplemental Restraint System
TRC	Traction Control
TWI	Treadwear indicator
VIN	Vehicle Identification Number
VSC	Vehicle Stability Control

## Alphabetical index

### Alphabetical index

<b>A</b>	<b>A/C</b> ..... 252, 258	<b>Audio system</b>
	<b>ABS</b> ..... 221	Antenna ..... 274
	<b>Air conditioning filter</b> ..... 511	Audio input..... 313
	<b>Air conditioning system</b>	AUX port ..... 313
	Air conditioning filter..... 511	CD player..... 275
	Air conditioning	iPod..... 290
	system ..... 252, 258	MP3/WMA disc ..... 282
	<b>Airbags</b>	Optimal use..... 309
	Airbag operating	Portable music player ..... 313
	conditions ..... 112	Radio ..... 270
	Airbag precautions for	Steering wheel
	your child ..... 117	audio switch..... 314
	Airbag warning light ..... 559	Type..... 268
	General airbag	USB memory ..... 300
	precautions ..... 117	<b>Automatic air conditioning</b>
	Locations of airbags..... 109	<b>system</b>
	Modification and disposal of	Air conditioning filter ..... 511
	airbags..... 121	Automatic
	Proper driving	air conditioning system..... 258
	posture..... 107, 117	<b>Automatic disconnecting</b>
	Side and curtain	<b>differential</b> ..... 214
	shield airbags operating	<b>Automatic light control</b>
	conditions ..... 112	<b>system</b> ..... 193
	Side and curtain shield	<b>Automatic transmission</b>
	airbags precautions ..... 117	Automatic transmission..... 166
	SRS airbags..... 109	If the shift lever cannot be
	<b>Antenna</b> ..... 274	shifted from P ..... 585
	<b>Anti-lock brake system</b> ..... 221	<b>AUX port</b> ..... 313, 369
	<b>Ashtray</b> ..... 452	<b>Auxiliary box</b> ..... 447
	<b>Audio input</b> ..... 313	

<b>B</b>	<b>C</b>
<b>Back window</b> ..... 95	<b>Care</b>
<b>Back-up lights</b>	Exterior ..... 468
Replacing light bulbs ..... 542	Interior ..... 472
Wattage ..... 622	Seat belts ..... 473
<b>Battery</b>	<b>CD player</b> ..... 275, 336
Checking ..... 496	<b>Chains</b> ..... 235
If the vehicle has discharged	<b>Child restraint system</b>
battery ..... 587	Baby seats, definition ..... 122
Preparing and checking	Baby seats, installation ..... 134
before winter ..... 235	Child seats, definition ..... 122
<b>Bluetooth® audio</b> ..... 370	Child seats, installation ..... 134
<b>Bluetooth® phone</b> ..... 395	Installing CRS with seat
<b>Bottle holders</b> ..... 446	belts ..... 135, 136
<b>Brake</b>	Junior seats, definition ..... 122
Parking brake ..... 174	Junior seats, installation ..... 134
<b>Brake assist</b> ..... 221	<b>Child safety</b>
<b>Break-in tips</b> ..... 146	Airbag precautions ..... 117
<b>Brightness control</b>	Battery precautions ..... 496, 590
Instrument panel light	Child restraint system ..... 122
control ..... 178	Child-protectors ..... 61
	How your child should wear
	the seat belt ..... 82
	Installing child restraints ..... 134
	Power window lock switch ..... 92
	Power window precautions ..... 93
	Removed key battery
	precautions ..... 515
	Seat belt precautions ..... 83
	Seat heater
	precautions ..... 456

<b>Child-protectors</b> .....	<b>61</b>	<b>Display audio</b>	
<b>Cigarette lighter</b> .....	<b>453</b>	Antenna .....	335, 381, 391
<b>Cleaning</b>		Audio input.....	352, 362, 369
Exterior.....	468	AUX port .....	369
Interior.....	472	Bluetooth® audio.....	370
Seat belts.....	473	Bluetooth® phone .....	395
<b>Clock</b> .....	<b>451</b>	CD player.....	336
<b>Compass</b> .....	<b>459</b>	iPod.....	350
<b>Condenser</b> .....	<b>495</b>	MP3/WMA disc .....	337
<b>Console box</b> .....	<b>443</b>	Radio .....	331
<b>Cooling system</b>		Steering wheel audio	
Engine overheating.....	592	switch .....	314
<b>Cruise control</b> .....	<b>202</b>	USB memory .....	360
<b>Cup holder</b> .....	<b>444</b>	<b>Do-it-yourself maintenance</b> ....	<b>480</b>
<b>Curtain shield airbags</b> .....	<b>109</b>	<b>Doors</b>	
		Door glasses.....	91
<b>D</b> <b>Daytime running light</b> .....	<b>193</b>	Door lock.....	48, 59
<b>Deck hooks</b> .....	<b>465</b>	Side doors.....	59
<b>Defogger</b>		Side mirrors .....	88
Rear window .....	266	<b>Driver's seat belt reminder</b>	
Side mirrors.....	266	<b>light</b> .....	<b>561</b>
<b>Diesel particulate filter</b>		<b>Driving</b>	
<b>system</b> .....	<b>227</b>	Correct posture.....	107
<b>Dimension</b> .....	<b>602</b>	Procedures .....	146
<b>Display</b>			
Multi-information			
display .....	185		
Touch screen .....	317		
Trip information .....	187		

<b>E</b>	<b>Emergency flashers</b>	
	Switch .....	548
	<b>Emergency, in case of</b>	
	If the engine will not start .....	584
	If the shift lever cannot be shifted from P .....	585
	If the vehicle has discharged battery.....	587
	If the warning buzzer sounds.....	557
	If the warning light turns on.....	557
	If you have a flat tire .....	565
	If you lose your keys .....	586
	If you run out of fuel and the engine stalls.....	595
	If you think something is wrong.....	555
	If your vehicle becomes stuck .....	596
	If your vehicle has to be stopped in an emergency .....	598
	If your vehicle needs to be towed.....	549
	If your vehicle overheats .....	592

<b>Engine</b>	
Compartment .....	486
Engine switch.....	162
Hood .....	484
How to start the engine.....	162
Identification number .....	607
If the engine will not start .....	584
If you run out of fuel and the engine stalls .....	595
If your vehicle has to be stopped in an emergency.....	598
Ignition switch .....	162
Overheating .....	592
<b>Engine coolant</b>	
Capacity.....	614
Checking.....	493
Preparing and checking before winter.....	235
<b>Engine coolant temperature gauge.....</b>	<b>176</b>
<b>Engine immobilizer system ....</b>	<b>102</b>
<b>Engine oil</b>	
Capacity.....	610, 612
Checking.....	488
Preparing and checking before winter.....	235
<b>Engine switch .....</b>	<b>162</b>
<b>Engine switch light.....</b>	<b>438</b>



<b>F</b>	<b>Floor mat</b> ..... 457	<b>Fuel door</b> ..... 96
	<b>Fluid</b>	<b>Fuel filler door</b> ..... 96
	Washer..... 500	<b>Fuel filter</b> ..... 502
	<b>Four-wheel drive system</b>	<b>Fuel pump shut off system</b> ..... 556
	Front drive control lever ..... 212	<b>Fuses</b> ..... 516
	<b>Front fog lights</b>	
	Replacing light bulbs..... 535	<b>G</b>
	Switch ..... 195	<b>Gas station information</b> ..... 644
	Wattage..... 622	<b>Gauges</b> ..... 176
	<b>Front passenger's seat belt</b>	<b>Glove box</b> ..... 442
	<b>reminder light</b> ..... 561	
	<b>Front position lights</b>	<b>H</b>
	Replacing light bulbs..... 537	<b>Hands-free system</b>
	Switch ..... 191	(for cellular phone)..... 387
	Wattage..... 622	<b>Head restraints</b>
	<b>Front seats</b>	Adjustment..... 75
	Adjustment..... 67	<b>Headlight cleaner</b> ..... 201
	<b>Front turn signal lights</b>	<b>Headlights</b>
	Replacing light bulbs..... 539	Replacing light bulbs..... 533
	Switch ..... 173	Switch ..... 191
	Wattage..... 622	Wattage ..... 622
	<b>Fuel</b>	<b>Heaters</b>
	Capacity..... 609	Seat heaters ..... 455
	Fuel gauge..... 176	Side mirror ..... 266
	Fuel pump shut off system..... 556	<b>Hood</b> ..... 484
	Gas station information ..... 644	<b>Hooks</b>
	If you run out of fuel and	Deck..... 465
	the engine stalls..... 595	<b>Horn</b> ..... 175
	Information ..... 623	
	Refueling..... 96	

<p><b>I</b></p> <p><b>Identification</b></p> <p>Engine ..... 607</p> <p>Vehicle ..... 606</p> <p><b>Ignition switch..... 162</b></p> <p><b>Ignition switch light..... 438</b></p> <p><b>Illuminated entry system..... 439</b></p> <p><b>Indicator lights ..... 180</b></p> <p><b>Initialization</b></p> <p>Items to initialize ..... 625</p> <p><b>Inside rear view mirror ..... 86</b></p> <p><b>Intercooler ..... 495</b></p> <p><b>Interior lights</b></p> <p>Interior lights ..... 438</p> <p>Switch ..... 439</p> <p>Wattage..... 622</p> <p><b>J</b></p> <p><b>Jack</b></p> <p>Vehicle-equipped jack..... 565</p> <p><b>Jack handle ..... 565</b></p> <p><b>K</b></p> <p><b>Keyless entry ..... 48</b></p> <p><b>Keys</b></p> <p>Engine switch..... 162</p> <p>If you lose your keys ..... 586</p> <p>Key number..... 46</p> <p>Keyless entry ..... 48</p> <p>Keys ..... 46</p> <p>Wireless remote control key.... 48</p>	<p><b>L</b></p> <p><b>License plate lights</b></p> <p>Replacing light bulbs..... 543</p> <p>Wattage ..... 622</p> <p><b>Light bulbs</b></p> <p>Replacing..... 532</p> <p>Wattage ..... 622</p> <p><b>Lights</b></p> <p>Engine switch light ..... 438</p> <p>Fog light switch ..... 195</p> <p>Headlights switch..... 191</p> <p>Interior light list..... 438</p> <p>Interior light switch ..... 439</p> <p>Personal light switch..... 439</p> <p>Replacing light bulbs..... 532</p> <p>Turn signal lever ..... 173</p> <p>Wattage ..... 622</p> <p><b>Limited slip differential ..... 221</b></p> <p><b>M</b></p> <p><b>Maintenance</b></p> <p>Do-it-yourself</p> <p>maintenance..... 480</p> <p>Maintenance data ..... 602</p> <p>Maintenance requirements ... 476</p> <p><b>Manual headlight leveling</b></p> <p><b>dial..... 192</b></p> <p><b>Manual transmission..... 170</b></p> <p><b>Meter</b></p> <p>Instrument panel light</p> <p>control..... 178</p> <p>Meters..... 176</p>
---	---

<b>Microphone</b> .....	388	<b>Q</b>	<b>Quarter windows</b> .....	94
<b>Mirrors</b>		<b>R</b>	<b>Radiator</b> .....	495
Inside rear view mirror .....	86		<b>Radio</b> .....	270, 331
Side mirror heater .....	266		<b>Rear differential lock</b>	
Side mirrors.....	88		<b>system</b> .....	217
Vanity mirrors.....	450		<b>Rear fog lights</b>	
<b>MP3 disc</b> .....	282, 337		Replacing light bulbs.....	542
<b>Multi-information</b>			Switch .....	196
<b>display</b> .....	185		Wattage .....	622
<b>O</b>			<b>Rear seat</b>	
<b>Odometer</b> .....	176		Removing the rear seat	
<b>Oil</b>			cushions .....	72
Engine oil .....	488		Tumbling the bottom	
<b>Opener</b>			cushion .....	73
Fuel filler door .....	96		<b>Rear step bumper</b> .....	65
Hood .....	484		<b>Rear turn signal lights</b>	
<b>Outside rear view mirrors</b>			Replacing light bulbs.....	542
Adjusting and folding.....	88		Wattage .....	622
<b>Outside temperature</b>			<b>Rear view monitor system</b> .....	207
<b>display</b> .....	187		<b>Rear window defogger</b> .....	266
<b>Overhead console</b> .....	447		<b>Replacing</b>	
<b>Overheating, Engine</b> .....	592		Fuses .....	516
<b>P</b>			Key battery.....	513
<b>Parking brake</b> .....	174		Light bulbs .....	532
<b>Personal lights</b>			Tires.....	565
Personal lights .....	438		Wireless remote control	
Switch .....	439		battery .....	513
Wattage.....	622			
<b>Power heater</b> .....	265			
<b>Power outlet</b> .....	454			
<b>Power windows</b> .....	91			

<b>S</b>	<b>Seat belts</b>		<b>Shift lever</b>	
	Adjusting the seat belt.....	80	Automatic transmission.....	166
	Child restraint system		Front drive control lever.....	212
	installation.....	134	If the shift lever cannot	
	Cleaning and maintaining		be shifted from P .....	585
	the seat belts .....	473	Manual transmission.....	170
	Emergency Locking		<b>Shift lock system .....</b>	<b>585</b>
	Retractor.....	81	<b>Side airbags .....</b>	<b>109</b>
	How to wear your seat belt .....	78	<b>Side doors .....</b>	<b>59</b>
	How your child should wear		<b>Side mirror</b>	
	the seat belt.....	82	Adjusting and folding .....	88
	Pregnant women, proper seat		<b>Side turn signal lights</b>	
	belt use .....	82	Replacing light bulbs.....	541
	Reminder light.....	561	Wattage .....	622
	Seat belt pretensioners.....	81	<b>Spare tire</b>	
	<b>Seat heaters .....</b>	<b>455</b>	Inflation pressure .....	507
	<b>Seats</b>		Storage location.....	565
	Adjustment.....	67	<b>Specifications .....</b>	<b>602</b>
	Adjustment		<b>Speedometer.....</b>	<b>176</b>
	precautions.....	71	<b>Steering</b>	
	Child seats/child restraint		Column lock release .....	164
	system installation .....	134	Fluid .....	619
	Cleaning.....	472	<b>Steering wheel</b>	
	Head restraint .....	75	Adjustment.....	85
	Properly sitting in the seat.....	107	Audio switches.....	314, 384
	Seat heaters.....	455	<b>Stop lights</b>	
	<b>Service reminder</b>		Replacing light bulbs.....	542
	<b>indicators .....</b>	<b>180</b>	Wattage .....	622
			<b>Storage feature .....</b>	<b>440</b>
			<b>Storage precautions.....</b>	<b>233</b>

<b>Stuck</b>		<b>Tires</b>	
If your vehicle becomes stuck .....	596	Chains.....	235
<b>Sun visors .....</b>	<b>449</b>	Checking.....	503
<b>Switch</b>		If you have a flat tire .....	565
Engine switch.....	162	Inflation pressure .....	507
Fog light switch .....	195	Replacing.....	565
Ignition switch .....	162	Rotating tires.....	503
Light switches .....	191	Size.....	620
Power door lock switch .....	60	Snow tires .....	235
Power window switch.....	91	Spare tire .....	565
Window lock switch.....	92	<b>Tools.....</b>	<b>565</b>
Wipers and washer switch.....	199	<b>Towing</b>	
<b>Tachometer .....</b>	<b>176</b>	Emergency towing .....	549
<b>Tail lights</b>		Trailer towing .....	239
Replacing light bulbs.....	542	<b>Traction control .....</b>	<b>221</b>
Switch .....	191	<b>Trailer towing.....</b>	<b>239</b>
Wattage.....	622	<b>TRC .....</b>	<b>221</b>
<b>Tailgate .....</b>	<b>63</b>	<b>Trip information</b>	
<b>Telephone switch.....</b>	<b>387</b>	<b>display.....</b>	<b>185</b>
<b>Theft deterrent system</b>		<b>Trip meter .....</b>	<b>176</b>
Engine immobilizer system .....	102	<b>Turn signal lights</b>	
<b>Tire inflation pressure.....</b>	<b>507</b>	Replacing	
		light bulbs .....	539, 541, 542
		Switch .....	173
		Wattage .....	622

<b>V</b>	<b>Valet key</b> .....	<b>46</b>	<b>Washer</b>	
	<b>Vanity mirrors</b> .....	<b>450</b>	Checking .....	500
	<b>Vehicle data recordings</b> .....	<b>38</b>	Preparing and checking	
	<b>Vehicle identification</b>		before winter .....	235
	<b>number</b> .....	<b>606</b>	Switch .....	199
	<b>Vehicle stability control</b> .....	<b>221</b>	<b>Washing and waxing</b> .....	<b>468</b>
	<b>VSC</b> .....	<b>221</b>	<b>Weight</b> .....	<b>603</b>
<b>W</b>	<b>Warning buzzers</b>		<b>Wheels</b> .....	<b>509</b>
	Key reminder .....	563	<b>Window glasses</b> .....	<b>91</b>
	Seat belt reminder .....	561	<b>Window lock switch</b> .....	<b>92</b>
	<b>Warning lights</b>		<b>Windows</b>	
	Anti-lock brake system .....	559	Power windows .....	91
	Automatic transmission fluid		Rear window defogger .....	266
	temperature .....	559	Washer .....	199
	Brake system .....	557	<b>Windshield wipers</b> .....	<b>199</b>
	Charging system .....	558	<b>Wireless remote control key</b>	
	Diesel particulate filter .....	560	Locking/Unlocking .....	48
	Electronic engine control		Replacing the battery .....	513
	system .....	558	Wireless remote control key ...	48
	Engine oil change		<b>WMA disc</b> .....	<b>282, 337</b>
	reminder .....	562		
	Fuel filter .....	560		
	Low engine oil level .....	562		
	Low engine oil pressure .....	558		
	Low fuel level .....	561		
	Malfunction indicator lamp .....	558		
	Open door .....	561		
	Seat belt reminder light .....	561		
	SRS airbags .....	559		
	Timing belt replacement .....	559		

**What to do if...**  
**What to do if...**

A tire punctures	P. 565	If you have a flat tire
The engine does not start	P. 584	If the engine will not start
	P. 595	If you run out of fuel and the engine stalls
	P. 102	Engine immobilizer system
	P. 587	If the vehicle battery is discharged
The shift lever cannot be moved out	P. 585	If the shift lever cannot be shifted from P
The engine coolant temperature gauge enters the red zone	P. 592	If your vehicle overheats
Steam can be seen coming from under the hood		
The key is lost	P. 586	If you lose your keys
The battery runs out	P. 587	If the vehicle battery is discharged
The doors cannot be locked	P. 59	Side doors
The vehicle is stuck in mud or sand	P. 596	If the vehicle becomes stuck





■ Center panel

Vehicles without multi-information display

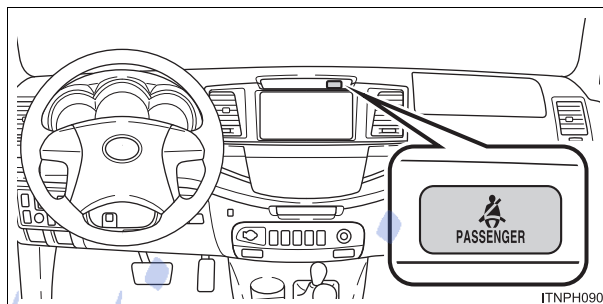



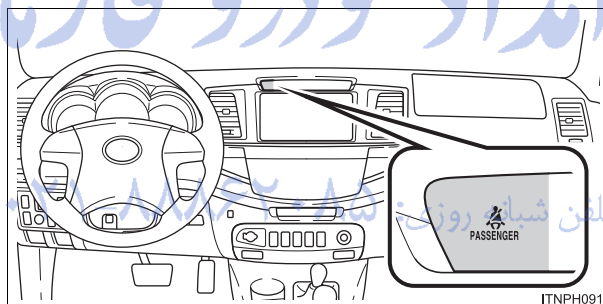

















Vehicles with multi-information display



FarmaSOS.com

■ Warning lights

	Brake system warning light P. 557		Timing belt replacement warning light P. 559
	Charging system warning light P. 558		Fuel system warning light P. 560
	Low engine oil pressure warning light P. 558		DPF system warning light P. 560
	Malfunction indicator lamp P. 558		Open door warning light P. 561
	SRS warning light P. 559		Low fuel level warning light P. 561
	ABS warning light P. 559		Driver's seat belt reminder light P. 561
	VSC OFF indicator light P. 559		Front passenger's seat belt reminder light P. 561
	Slip indicator light P. 559		Unengaged "Park" warning light P. 561
	Cruise control indicator light P. 559		Low engine oil level warning light P. 562
	Automatic transmission fluid temperature warning light P. 559		Engine oil change reminder light P. 562
			Four-wheel drive indicator light P. 559

# امداد خودرو فارما

تلفن شبانه روزی: ۰۲۱-۸۸۸۶۲۰۸۵

**FarmaSOS.com**

## GAS STATION INFORMATION

**Auxiliary catch lever**  
P. 484

**Fuel filler door**  
P. 96

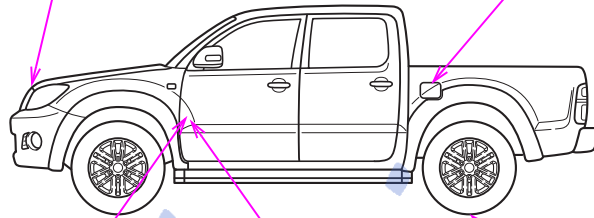

ITNPH059a

**Fuel filler door opener**  
P. 96

**Hood lock release lever**  
P. 484

**Tire inflation pressure**  
P. 620

Fuel tank capacity (Reference)	80 L (21.1 gal., 17.6 Imp.gal.)
Fuel type	P. 99, 609
Cold tire inflation pressure	P. 620
Engine oil capacity (Drain and refill — reference)	L (qt., Imp.qt.) With filter 6.9 (7.3, 6.1) Without filter 6.6 (7.0, 5.8)
Engine oil type	P. 610, 612