

	<b>Pictorial index</b>	Search by illustration
1	<b>For safety and security</b>	Make sure to read through them
2	<b>Instrument cluster</b>	How to read the gauges and meters, the variety of warning lights and indicators, etc.
3	<b>Operation of each component</b>	Opening and closing the doors and windows, adjustment before driving, etc.
4	<b>Driving</b>	Operations and advices which are necessary for driving
5	<b>Interior features</b>	Usage of the interior features, etc.
6	<b>Maintenance and care</b>	Caring for your vehicle and maintenance procedures
7	<b>When trouble arises</b>	What to do in case of malfunction or emergency
8	<b>Vehicle specifications</b>	Vehicle specifications, customizable features, etc.
9	<b>For owners</b>	Reporting safety defects for U.S. owners, and seat belt and SRS airbag instructions for Canadian owners
	<b>Index</b>	Search by symptom
		Search alphabetically

For your information.....	6
Reading this manual .....	10
How to search.....	11
Pictorial index .....	12

## 1 For safety and security

<b>1-1. For safe use</b>	
Before driving .....	22
For safety drive .....	24
Seat belts .....	26
SRS airbags .....	34
Front passenger occupant classification system .....	46
Safety information for children .....	52
Child restraint systems.....	53
Installing child restraints.....	57
Exhaust gas precautions.....	66
<b>1-2. Theft deterrent system</b>	
Engine immobilizer system.....	67
Theft prevention labels (except Canada) .....	69

## 2 Instrument cluster

<b>2. Instrument cluster</b>	
Warning lights and indicators.....	72
Gauges and meters.....	76
Multi-information display .....	78

## 3 Operation of each component

<b>3-1. Key information</b>	
Keys.....	84
<b>3-2. Opening, closing and locking the doors</b>	
Side doors .....	89
Back door .....	94
<b>3-3. Adjusting the seats</b>	
Front seats.....	98
Rear seats .....	101
Head restraints .....	104
<b>3-4. Adjusting the steering wheel and mirrors</b>	
Steering wheel.....	107
Inside rear view mirror .....	109
Outside rear view mirrors .....	111
<b>3-5. Opening and closing the windows</b>	
Power windows.....	113

## 4 Driving

### 4-1. Before driving

Driving the vehicle.....	116
Cargo and luggage.....	127
Vehicle load limits .....	131
Trailer towing.....	132
Dinghy towing (vehicles with an automatic transmission).....	133
Dinghy towing (vehicles with a manual transmission).....	134

### 4-2. Driving procedures

Engine (ignition) switch .....	136
Automatic transmission .....	139
Manual transmission .....	141
Turn signal lever.....	142
Parking brake .....	143

### 4-3. Operating the lights and wipers

Headlight switch .....	144
Fog light switch .....	147
Windshield wipers and washer .....	149
Rear window wiper and washer .....	152

### 4-4. Refueling

Opening the fuel tank cap .....	155
------------------------------------	-----

### 4-5. Using the driving support systems

Cruise control .....	158
Driving assist systems.....	162

### 4-6. Driving tips

Winter driving tips.....	167
--------------------------	-----

## 5 Interior features

### 5-1. Using the air conditioning system and defogger

Air conditioning system.....	172
------------------------------	-----

### 5-2. Using the audio system

Steering wheel audio switches.....	180
AUX port/USB port .....	181

### 5-3. Using the interior lights

Interior lights list.....	182
• Interior light .....	182
• Personal lights.....	183

### 5-4. Using the storage features

List of storage features .....	184
• Glove box .....	185
• Cup holders .....	185
• Bottle holders .....	186
• Auxiliary box.....	187
Luggage compartment features .....	188

### 5-5. Using the other interior features

Other interior features.....	190
• Sun visors .....	190
• Vanity mirrors .....	190
• Power outlet .....	191
• Assist grips .....	192

## 6 Maintenance and care

### 6-1. Maintenance and care

- Cleaning and protecting the vehicle exterior ..... 194
- Cleaning and protecting the vehicle interior ..... 197

### 6-2. Maintenance

- Maintenance requirements ..... 200
- General maintenance ..... 202
- Emission inspection and maintenance (I/M) program ..... 205

### 6-3. Do-it-yourself maintenance

- Do-it-yourself service precautions ..... 206
- Hood ..... 209
- Positioning a floor jack ..... 211
- Engine compartment ..... 213
- Tires ..... 223
- Tire inflation pressure ..... 231
- Wheels ..... 235
- Air conditioning filter ..... 238
- Wireless remote control battery ..... 240
- Checking and replacing fuses ..... 243
- Light bulbs ..... 248

## 7 When trouble arises

### 7-1. Essential information

- Emergency flashers ..... 262
- If your vehicle has to be stopped in an emergency ..... 263

### 7-2. Steps to take in an emergency

- If your vehicle needs to be towed ..... 265
- If you think something is wrong ..... 270
- Fuel pump shut off system ..... 271
- If a warning light turns on or a warning buzzer sounds ..... 272
- If you have a flat tire ..... 281
- If the engine will not start ... 294
- If the shift lever cannot be shifted from P (vehicles with an automatic transmission) ..... 296
- If the vehicle battery is discharged ..... 297
- If your vehicle overheats .... 300
- If the vehicle becomes stuck ..... 303

## 8 Vehicle specifications

### 8-1. Specifications

Maintenance data (fuel, oil level, etc.) .....	306
Fuel information .....	317
Tire information .....	320

### 8-2. Customization

Customizable features .....	333
Items to initialize.....	335

## 9 For owners

Reporting safety defects for U.S. owners.....	338
--	-----

Seat belt instructions for Canadian owners (in French) .....	339
--	-----

SRS airbag instructions for Canadian owners (in French) .....	341
---	-----

## Index

What to do if... (Troubleshooting) .....	352
Alphabetical index.....	355

1

2

3

4

5

6

7

8

9

امداد خودرو فارما

تلفن شبانه روزی: ۰۲۱-۸۸۶۲۰۸۵

FarmaSOS.com

## For your information

### Main Owner's Manual

Please note that this manual applies to all models and explains all equipment, including options. Therefore, you may find some explanations for equipment not installed on your vehicle.

All specifications provided in this manual are current at the time of printing. However, because of the Toyota policy of continual product improvement, we reserve the right to make changes at any time without notice.

Depending on specifications, the vehicle shown in the illustrations may differ from your vehicle in terms of equipment.

### Noise from under vehicle after turning off the engine

Approximately five hours after the engine is turned off, you may hear a sound coming from under the vehicle for several minutes. This is the sound of a fuel evaporation leakage check and, it does not indicate a malfunction.

### Accessories, spare parts and modification of your Toyota

A wide variety of non-genuine spare parts and accessories for Toyota vehicles are currently available on the market. You should know that Toyota does not warrant these products and is not responsible for their performance, repair, or replacement, or for any damage they may cause to, or adverse effect they may have on, your Toyota vehicle. تلفن شبانه روز

This vehicle should not be modified with non-genuine Toyota products. Modification with non-genuine Toyota products could affect its performance, safety or durability, and may even violate governmental regulations. In addition, damage or performance problems resulting from the modification may not be covered under warranty.

## Installation of a mobile two-way radio system

The installation of a mobile two-way radio system in your vehicle could affect electronic systems such as:

- Multiport fuel injection system/sequential multiport fuel injection system
- Cruise control system (if equipped)
- Anti-lock brake system
- SRS airbag system
- Seat belt pretensioner system

Be sure to check with your Toyota dealer for precautionary measures or special instructions regarding installation of a mobile two-way radio system.

## Vehicle data recordings

Your Toyota is equipped with several sophisticated computers that will record certain data, such as:

- Engine speed
- Accelerator status
- Brake status
- Vehicle speed
- Shift position (except manual transmission)

The recorded data varies according to the vehicle grade level and options with which it is equipped. Furthermore, these computers do not record conversations, sounds or pictures.

### ● Data usage

Toyota may use the data recorded in these computers to diagnose malfunctions, conduct research and development, and improve quality.

Toyota will not disclose the recorded data to a third party except:

- With the consent of the vehicle owner or with the consent of the lessee if the vehicle is leased
- In response to an official request by the police, a court of law or a government agency
- For use by Toyota in a lawsuit
- For research purposes where the data is not tied to a specific vehicle or vehicle owner

## Event data recorder

This vehicle is equipped with an event data recorder (EDR). The main purpose of an EDR is to record, in certain crash or near crash-like situations, such as an airbag deployment or hitting a road obstacle, data that will assist in understanding how a vehicle's systems performed. The EDR is designed to record data related to vehicle dynamics and safety systems for a short period of time, typically 30 seconds or less.

The EDR in this vehicle is designed to record such data as:

- How various systems in your vehicle were operating;
- Whether or not the driver and passenger safety belts were buckled/fastened;
- How far (if at all) the driver was depressing the accelerator and/or brake pedal; and,
- How fast the vehicle was traveling.

These data can help provide a better understanding of the circumstances in which crashes and injuries occur.

NOTE: EDR data are recorded by your vehicle only if a non-trivial crash situation occurs; no data are recorded by the EDR under normal driving conditions and no personal data (e.g., name, gender, age, and crash location) are recorded. However, other parties, such as law enforcement, could combine the EDR data with the type of personally identifying data routinely acquired during a crash investigation.

To read data recorded by an EDR, special equipment is required, and access to the vehicle or the EDR is needed. In addition to the vehicle manufacturer, other parties, such as law enforcement, that have the special equipment, can read the information if they have access to the vehicle or the EDR.

### ● Disclosure of the EDR data

Toyota will not disclose the data recorded in an EDR to a third party except when:

- An agreement from the vehicle's owner (or the lessee for a leased vehicle) is obtained
- In response to an official request by the police, a court of law or a government agency
- For use by Toyota in a lawsuit

However, if necessary, Toyota may:

- Use the data for research on vehicle safety performance
- Disclose the data to a third party for research purposes without disclosing information about the specific vehicle or vehicle owner



## Scrapping of your Toyota

The SRS airbag and seat belt pretensioner devices in your Toyota contain explosive chemicals. If the vehicle is scrapped with the airbags and seat belt pretensioners left as they are, this may cause an accident such as fire. Be sure to have the systems of the SRS airbag and seat belt pretensioner removed and disposed of by a qualified service shop or by your Toyota dealer before you scrap your vehicle.

## Perchlorate Material

Special handling may apply,  
See [www.dtsc.ca.gov/hazardouswaste/perchlorate](http://www.dtsc.ca.gov/hazardouswaste/perchlorate).

Your vehicle has components that may contain perchlorate. These components may include airbag, seat belt pretensioners, and wireless remote control batteries.

### WARNING

#### ■ General precautions while driving

**Driving under the influence:** Never drive your vehicle when under the influence of alcohol or drugs that have impaired your ability to operate your vehicle. Alcohol and certain drugs delay reaction time, impair judgment and reduce coordination, which could lead to an accident that could result in death or serious injury.

**Defensive driving:** Always drive defensively. Anticipate mistakes that other drivers or pedestrians might make and be ready to avoid accidents.

**Driver distraction:** Always give your full attention to driving. Anything that distracts the driver, such as adjusting controls, talking on a cellular phone or reading can result in a collision with resulting death or serious injury to you, your occupants or others.

#### ■ General precaution regarding children's safety

Never leave children unattended in the vehicle, and never allow children to have or use the key.

Children may be able to start the vehicle or shift the vehicle into neutral. There is also a danger that children may injure themselves by playing with the cigarette lighter, the windows, or other features of the vehicle. In addition, heat build-up or extremely cold temperatures inside the vehicle can be fatal to children.

## Reading this manual



### WARNING:

Explains something that, if not obeyed, could cause death or serious injury to people.



### NOTICE:

Explains something that, if not obeyed, could cause damage to or a malfunction in the vehicle or its equipment.



Indicates operating or working procedures. Follow the steps in numerical order.



Indicates the action (pushing, turning, etc.) used to operate switches and other devices.



Indicates the outcome of an operation (e.g. a lid opens).

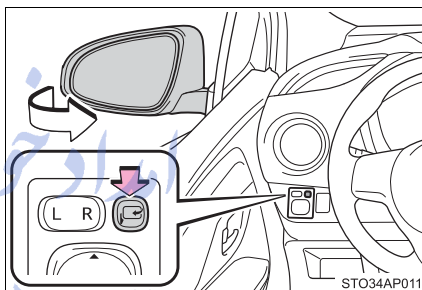

Indicates the component or position being explained.



Means “Do not”, “Do not do this”, or “Do not let this happen”.

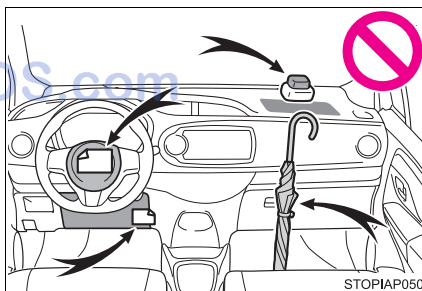

## How to search

### ■ Searching by name

- Alphabetical index .....P. 355

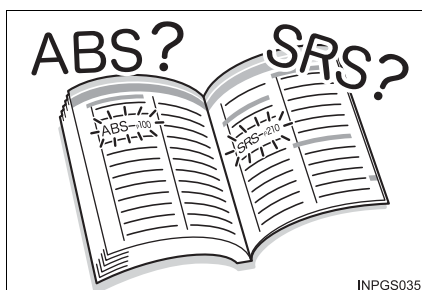

### ■ Searching by installation position

- Pictorial index .....P. 12

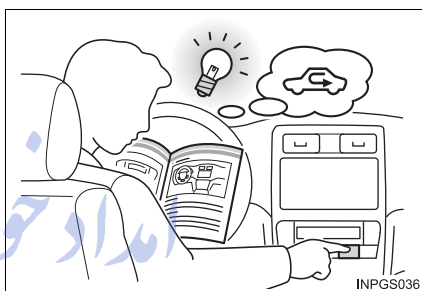

### ■ Searching by symptom or sound

- What to do if...  
(Troubleshooting) .....P. 352

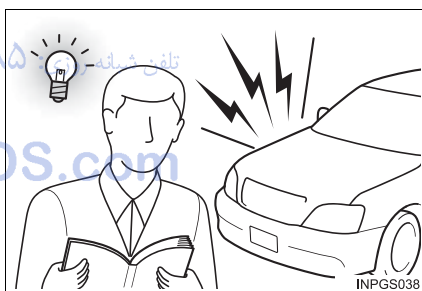

### ■ Searching by title

- Table of contents .....P. 2

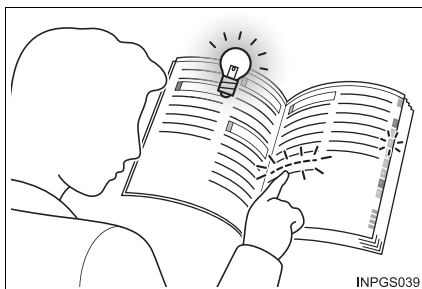

# Pictorial index

## Exterior

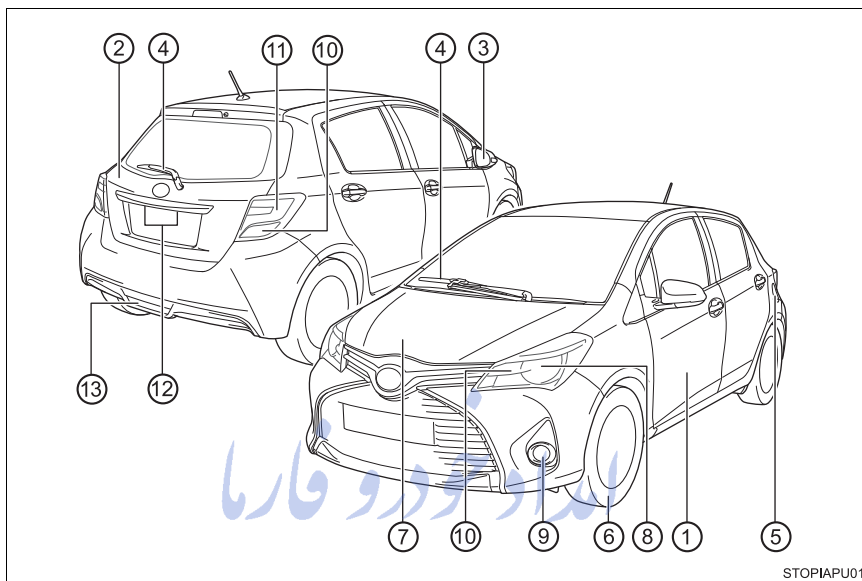

STOPIAPU01

The illustration represents the 5-door models and may differ from the body shape of the 3-door models.

- |   |  |               |
|---|--|---------------|
| ① | <b>Side doors</b> .....                | <b>P. 89</b>  |
|   | Locking/unlocking .....                | P. 89         |
|   | Opening/closing the door glasses ..... | P. 113        |
|   | Warning lights .....                   | P. 274        |
| ② | <b>Back door</b> .....                 | <b>P. 94</b>  |
|   | Locking/unlocking .....                | P. 94         |
|   | Warning lights .....                   | P. 274        |
| ③ | <b>Outside rear view mirrors</b> ..... | <b>P. 111</b> |
|   | Adjusting the mirror angle .....       | P. 111        |
|   | Folding the mirrors .....              | P. 112        |
|   | Defogging the mirrors* .....           | P. 176        |

- ④ **Wipers** ..... P. 149, 152  
 Precautions against winter season ..... P. 167
- ⑤ **Fuel filler door** ..... P. 155  
 Refueling method ..... P. 155  
 Fuel type/fuel tank capacity ..... P. 310
- ⑥ **Tires** ..... P. 223  
 Tire size/inflation pressure ..... P. 315  
 Winter tires/tire chain ..... P. 168  
 Checking/rotation ..... P. 223  
 Coping with flat tires ..... P. 281
- ⑦ **Hood** ..... P. 209  
 Opening ..... P. 209  
 Engine oil ..... P. 310  
 Coping with overheat ..... P. 300

#### Light bulbs of the exterior lights for driving

(Replacing method: P. 248, Watts: P. 316)

- ⑧ **Headlights/daytime running lights** ..... P. 144
- ⑨ **Fog lights\*** ..... P. 147
- ⑩ **Turn signal lights** ..... P. 142
- ⑪ **Stop/tail lights** ..... P. 144
- ⑫ **License plate lights** ..... P. 144
- ⑬ **Back-up lights** ..... P. 139, 141  
 Shifting the shift lever to R. ....

\*: If equipped

## Instrument panel

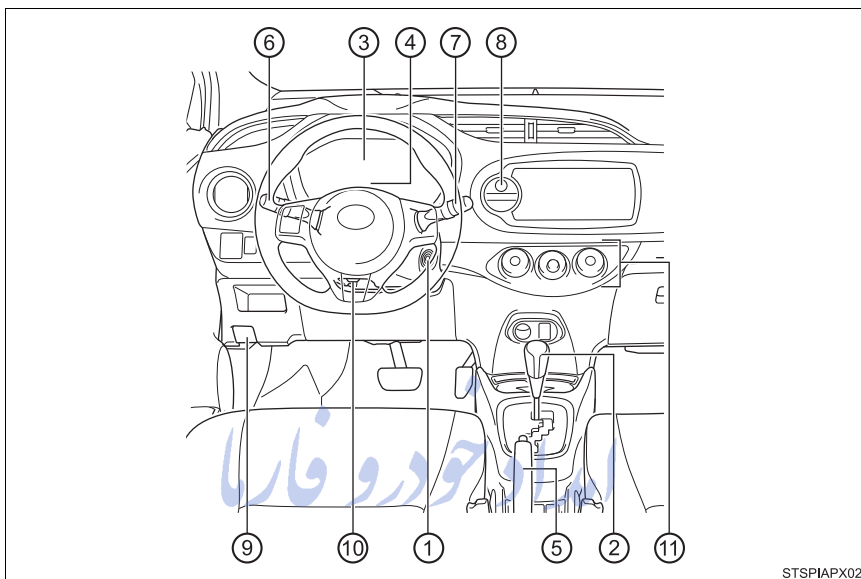

STSPIAPX02

- ① **Engine switch** ..... **P. 136**  
 Starting the engine ..... P. 136  
 Changing engine switch positions ..... P. 136  
 Emergency stop of the engine ..... P. 263  
 When the engine will not start ..... P. 294
- ② **Shift lever** ..... **P. 139, 141**  
 Changing the shift position ..... P. 139, 141  
 Precautions against towing ..... P. 265  
 When the shift lever does not move\*1 ..... P. 296
- ③ **Meters** ..... **P. 76**  
 Reading the meters ..... P. 76  
 Warning lights/indicator lights ..... P. 72  
 When the warning lights come on ..... P. 272

④	<b>Multi-information display</b> .....	<b>P. 78</b>
⑤	<b>Parking brake</b> .....	<b>P. 143</b>
	Applying/releasing .....	P. 143
	Precautions against winter season .....	P. 168
	Warning buzzer .....	P. 272
⑥	<b>Turn signal lever</b> .....	<b>P. 142</b>
	<b>Headlight switch</b> .....	<b>P. 144</b>
	Headlights/front position lights/tail lights .....	P. 144
	Fog lights* <sup>2</sup> .....	P. 147
⑦	<b>Wiper and washer switch</b> .....	<b>P. 149, 152</b>
	Usage (front) .....	P. 149
	Usage (rear) .....	P. 152
	Adding washer fluid .....	P. 221
⑧	<b>Emergency flasher switch</b> .....	<b>P. 262</b>
⑨	<b>Hood lock release lever</b> .....	<b>P. 209</b>
⑩	<b>Tilt steering lock release lever</b> .....	<b>P. 107</b>
⑪	<b>Air conditioning system</b> .....	<b>P. 172</b>
	Usage .....	P. 172
	Rear window defogger .....	P. 176

FarmaSOS.com

\*1: Except manual transmission

\*2: If equipped

## Switches

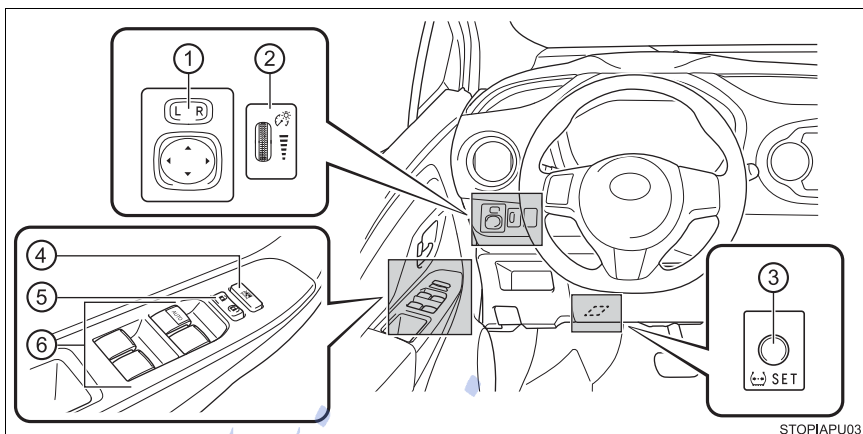

STOPIAPU03

- ① Outside rear view mirror switches ..... P. 111
- ② Instrument panel light control dial ..... P. 77
- ③ Tire pressure warning reset switch ..... P. 225
- ④ Window lock switch ..... P. 113
- ⑤ Door lock switches ..... P. 91
- ⑥ Power window switches ..... P. 113



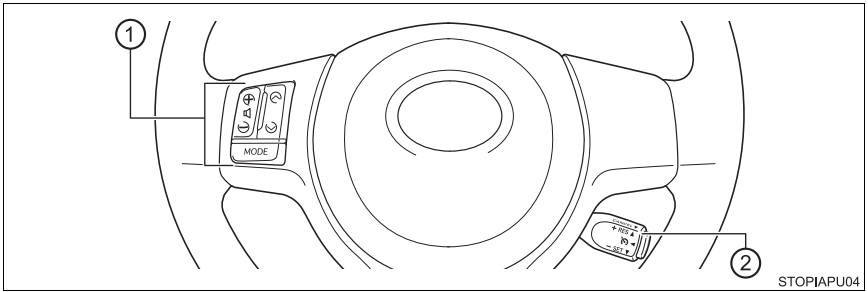

- ① Audio remote control switches\* ..... P. 180
- ② Cruise control switch\* ..... P. 158

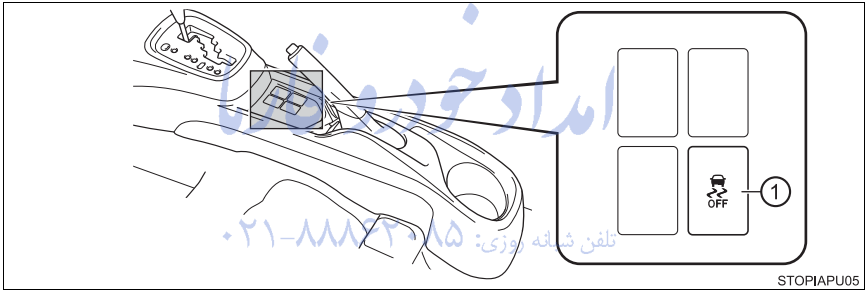

- ① VSC OFF switch\* ..... P. 163

\*: If equipped

## Interior

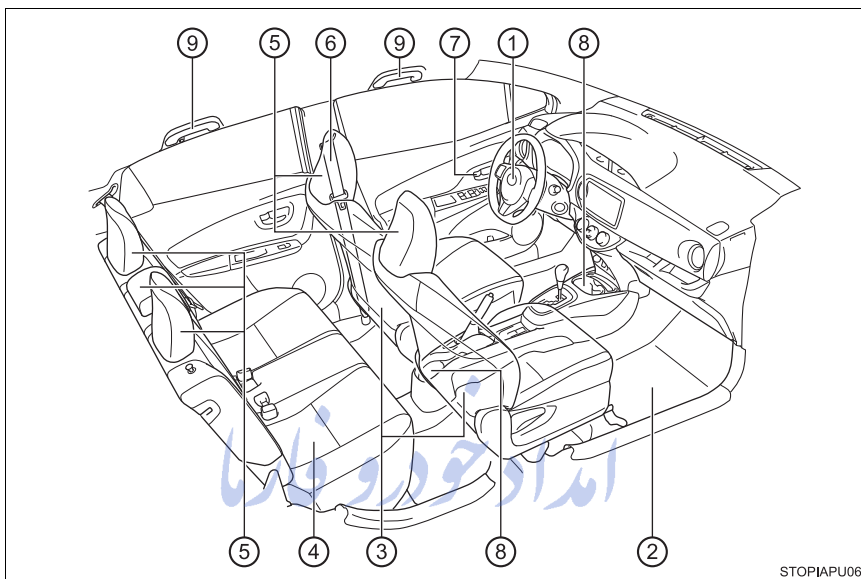

STOPIAPU06

- تلفن شماره روزی: ۰۲۱-۸۸۶۲۰۸۵
- ① SRS airbags ..... P. 34
- ② Floor mats ..... P. 22
- ③ Front seats ..... P. 98
- ④ Rear seats ..... P. 101
- ⑤ Head restraints ..... P. 104
- ⑥ Seat belts ..... P. 26
- ⑦ Inside lock buttons ..... P. 91
- ⑧ Cup holders ..... P. 185
- ⑨ Assist grips ..... P. 192

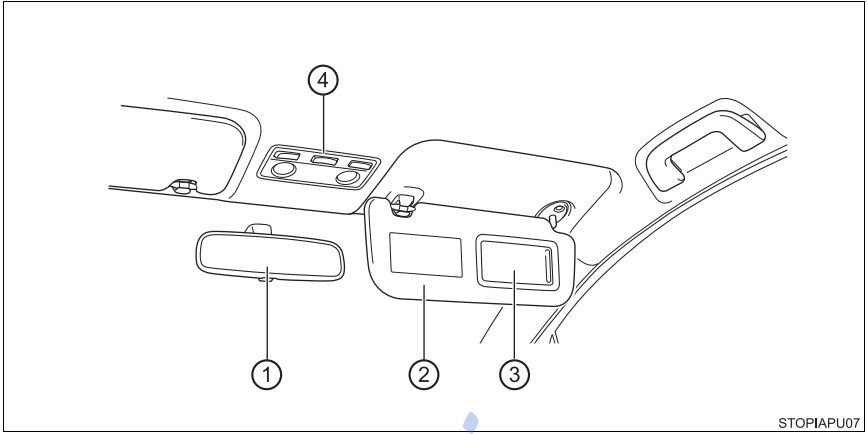

STOPIAPU07

- ① Inside rear view mirror ..... P. 109
- ② Sun visors ..... P. 190
- ③ Vanity mirrors..... P. 190
- ④ Interior light/personal lights ..... P. 182

تلفن شبانه روزی: ۰۲۱-۸۸۶۲۰۸۵

FarmaSOS.com

\*: If equipped

# امداد خودرو فارما

تلفن شبانه روزی: ۰۲۱-۸۸۸۶۲۰۸۵

**FarmaSOS.com**

## For safety and security

# 1

### 1-1. For safe use

Before driving.....	22
For safety drive .....	24
Seat belts .....	26
SRS airbags.....	34
Front passenger occupant classification system .....	46
Safety information for children .....	52
Child restraint systems.....	53
Installing child restraints.....	57
Exhaust gas precautions.....	66

### 1-2. Theft deterrent system

Engine immobilizer system .....	67
Theft prevention labels (except Canada) .....	69

## Before driving

### Floor mat

Use only floor mats designed specifically for vehicles of the same model and model year as your vehicle. Fix them securely in place onto the carpet.

- 1 Insert the retaining hooks (clips) into the floor mat eyelets.

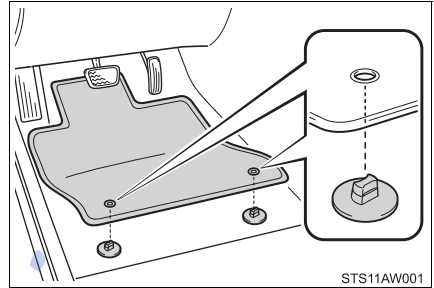

- 2 Turn the upper knob of each retaining hook (clip) to secure the floor mats in place.

\*: Always align the  $\triangle$  marks.

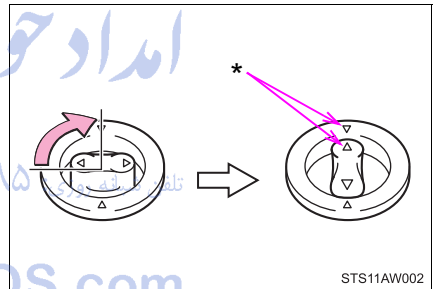

The shape of the retaining hooks (clips) may differ from that shown in the illustration.

**⚠ WARNING**

Observe the following precautions.

Failure to do so may cause the driver's floor mat to slip, possibly interfering with the pedals while driving. An unexpectedly high speed may result or it may become difficult to stop the vehicle, leading to an accident, or leading to death or a serious injury.

**■ When installing the driver's floor mat**

- Do not use floor mats designed for other models or different model year vehicles, even if they are Toyota Genuine floor mats.
- Only use floor mats designed for the driver's seat.
- Always install the floor mat securely using the retaining hooks (clips) provided.
- Do not use two or more floor mats on top of each other.
- Do not place the floor mat bottom-side up or upside-down.

**■ Before driving**

- Check that the floor mat is securely fixed in the correct place with all the provided retaining hooks (clips). Be especially careful to perform this check after cleaning the floor.
- With the engine stopped and the shift lever in P (automatic transmission) or N (manual transmission), fully depress each pedal to the floor to make sure it does not interfere with the floor mat.

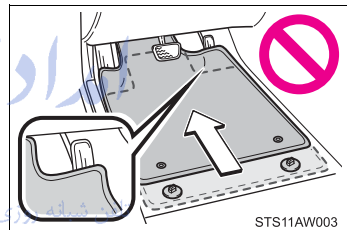

## For safety drive

**For safe driving, adjust the seat and mirror to an appropriate position before driving.**

### Correct driving posture

- ① Adjust the angle of the seat-back so that you are sitting straight up and so that you do not have to lean forward to steer. (→P. 98)
- ② Adjust the seat so that you can depress the pedals fully and so that your arms bend slightly at the elbow when gripping the steering wheel. (→P. 98, 107)

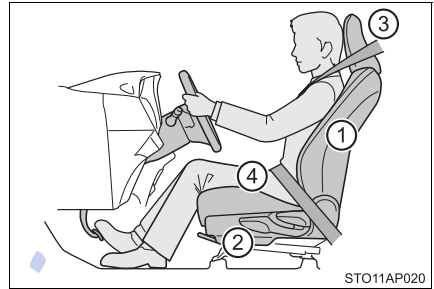

- ③ Lock the head restraint in place with the center of the head restraint closest to the top of your ears. (→P. 104)
- ④ Wear the seat belt correctly. (→P. 26)

### Correct use of the seat belts

Make sure that all occupants are wearing their seat belts before driving the vehicle. (→P. 26)

Use a child restraint system appropriate for the child until the child becomes large enough to properly wear the vehicle's seat belt. (→P. 53)

### Adjusting the mirrors

Make sure that you can see the rear of the vehicle clearly, by adjusting the inside and outside rear view mirrors properly. (→P. 109, 111)



 **WARNING**

Observe the following precautions.

Failure to do so may result in death or serious injury.

- Do not adjust the position of the driver's seat while driving.  
Doing so could cause the driver to lose control of the vehicle.
- Do not place a cushion between the driver or passenger and the seatback.  
A cushion may prevent correct posture from being achieved, and reduce the effectiveness of the seat belt and head restraint.
- Do not place anything under the front seats.  
Objects placed under the front seats may become jammed in the seat tracks and stop the seat from locking in place. This may lead to an accident and the adjustment mechanism may also be damaged.

امداد خودرو فارما

تلفن شبانه روزی: ۰۲۱-۸۸۶۲۰۸۵

FarmaSOS.com

## Seat belts

**Make sure that all occupants are wearing their seat belts before driving the vehicle.**

### Correct use of the seat belts

- Extend the shoulder belt so that it comes fully over the shoulder, but does not come into contact with the neck or slide off the shoulder.
- Position the lap belt as low as possible over the hips.
- Adjust the position of the seat-back. Sit up straight and well back in the seat.
- Do not twist the seat belt.

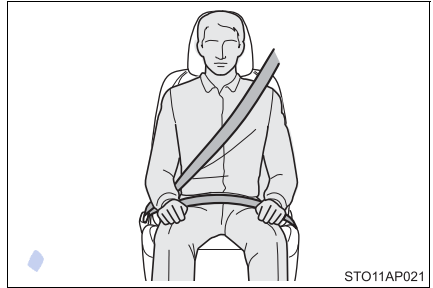

### Fastening and releasing the seat belt

- ① To fasten the seat belt, push the plate into the buckle until a click sound is heard.
- ② To release the seat belt, press the release button.

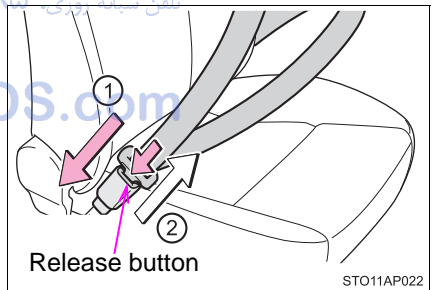

## Fastening the rear center seat belt

- 1 Take out the plate, and then pull the seat belt.



- 2 Push the plate into the buckle in the order of plate "A" and plate "B" until a clicking sound is heard.

- ① Plate "A", buckle "A"
- ② Plate "B", buckle "B"

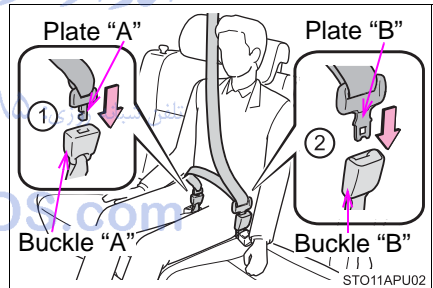

## Releasing and stowing the rear center seat belt

- 1 To release the hooked buckle "B", push the buckle release button.

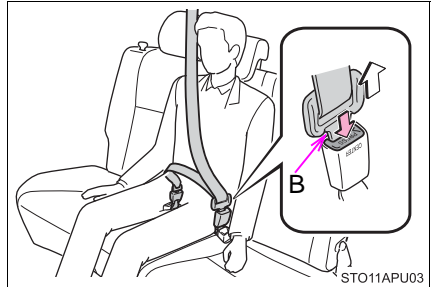

- 2 To release the hooked plate "A", insert the plate "B", the key into the hole on the buckle.

When releasing the seat belt, retract it slowly.

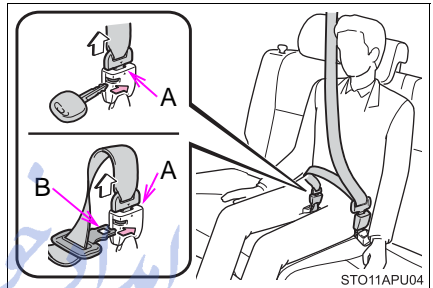

- 3 Stow the plates as shown in the illustration.

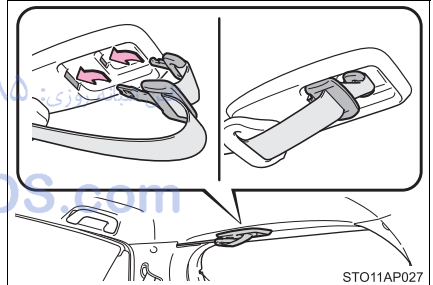

## Seat belt pretensioners (front seat)

The pretensioners help the seat belts to quickly restrain the occupants by retracting the seat belts when the vehicle is subjected to certain types of severe frontal collision.

The pretensioners do not activate in the event of a minor frontal impact, a minor side impact, a rear impact or a vehicle rollover.

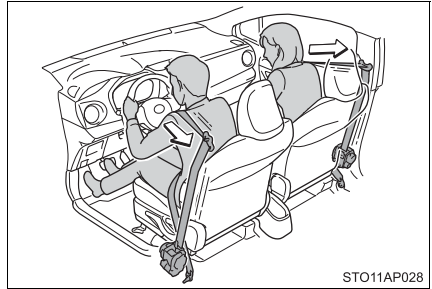

### ■ Emergency locking retractor (ELR)

The retractor will lock the belt during a sudden stop or on impact. It may also lock if you lean forward too quickly. A slow, easy motion will allow the belt to extend so that you can move around fully.

### ■ Automatic locking retractor (ALR)

When a passenger's shoulder belt is completely extended and then retracted even slightly, the belt is locked in that position and cannot be extended. This feature is used to hold the child restraint system (CRS) firmly. To free the belt again, fully retract the belt and then pull the belt out once more. (→P. 57)

### ■ Child seat belt usage

The seat belts of your vehicle were principally designed for persons of adult size.

- Use a child restraint system appropriate for the child, until the child becomes large enough to properly wear the vehicle's seat belt. (→P. 53)
- When the child becomes large enough to properly wear the vehicle's seat belt, follow the instructions regarding seat belt usage. (→P. 26)

### ■ Replacing the belt after the pretensioner has been activated

If the vehicle is involved in multiple collisions, the pretensioner will activate for the first collision, but will not activate for the second or subsequent collisions.

### ■ Seat belt extender

If your seat belts cannot be fastened securely because they are not long enough, a personalized seat belt extender is available from your Toyota dealer free of charge.

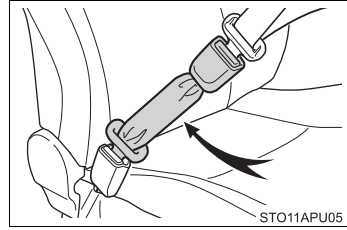

### ⚠ WARNING

Observe the following precautions to reduce the risk of injury in the event of sudden braking, sudden swerving or an accident. Failure to do so may cause death or serious injury.

#### ■ Wearing a seat belt

- Ensure that all passengers wear a seat belt.
- Always wear a seat belt properly.
- Each seat belt should be used by one person only. Do not use a seat belt for more than one person at once, including children.
- Toyota recommends that children be seated in the rear seats and always use a seat belt and/or an appropriate child restraint system.
- To achieve a proper seating position, do not recline the seat more than necessary. The seat belt is most effective when the occupants are sitting up straight and well back in the seats.
- Do not wear the shoulder belt under your arm.
- Always wear your seat belt low and snug across your hips.

## WARNING

### ■ Pregnant women

Obtain medical advice and wear the seat belt in the proper way. (→P. 26)

Women who are pregnant should position the lap belt as low as possible over the hips in the same manner as other occupants, extending the shoulder belt completely over the shoulder and avoiding belt contact with the rounding of the abdominal area.

If the seat belt is not worn properly, not only the pregnant woman, but also the fetus could suffer death or serious injury as a result of sudden braking or a collision.

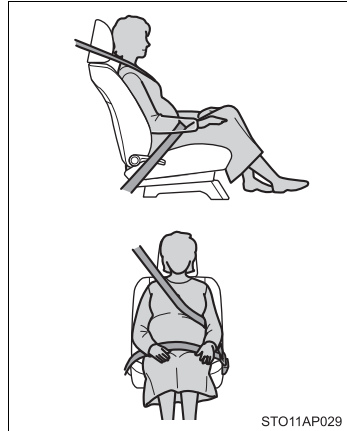

### ■ People suffering illness

Obtain medical advice and wear the seat belt in the proper way. (→P. 26)

### ■ When children are in the vehicle

Do not allow children to play with the seat belt. If the seat belt becomes twisted around a child's neck, it may lead to choking or other serious injuries that could result in death.

If this occurs and the buckle cannot be unfastened, scissors should be used to cut the belt.

### ■ Seat belt pretensioners

- Do not place anything, such as a cushion, on the front passenger's seat. Doing so will disperse the passenger's weight, which prevents the sensor from detecting the passenger's weight properly. As a result, the seat belt pretensioner for the front passenger's seat may not activate in the event of a collision.
- If the pretensioner has activated, the SRS warning light will come on. In that case, the seat belt cannot be used again and must be replaced at your Toyota dealer.

## WARNING

### ■ Seat belt damage and wear

- Do not damage the seat belts by allowing the belt, plate, or buckle to be jammed in the door.
- Inspect the seat belt system periodically. Check for cuts, fraying, and loose parts. Do not use a damaged seat belt until it is replaced. Damaged seat belts cannot protect an occupant from death or serious injury.
- Ensure that the belt and plate are locked and the belt is not twisted. If the seat belt does not function correctly, immediately contact your Toyota dealer.
- Replace the seat assembly, including the belts, if your vehicle has been involved in a serious accident, even if there is no obvious damage.
- Do not attempt to install, remove, modify, disassemble or dispose of the seat belts. Have any necessary repairs carried out by your Toyota dealer. Inappropriate handling may lead to incorrect operation.

### ■ When using the rear center seat belt

- Do not use the rear center seat belt with either buckle released.

Fastening only one of the buckles may result in death or serious injury in case of sudden braking or a collision.

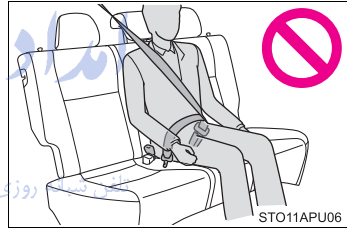

- Do not allow anyone sit on the rear center seat if the rear right seat is folded down, as the seat belt buckle for the rear center seat belt is then concealed under the folded seat and cannot be used.



**WARNING****■ Using a seat belt extender**

- Do not wear the seat belt extender if you can fasten the seat belt without the extender.
- Do not use the seat belt extender when installing a child restraint system because the belt will not securely hold the child restraint system, increasing the risk of death or serious injury in the event of an accident.
- The personalized extender may not be safe on another vehicle, when used by another person, or at a different seating position other than the one originally intended.

**NOTICE****■ When using a seat belt extender**

When releasing the seat belt, press on the buckle release button on the extender, not on the seat belt.

This helps prevent damage to the vehicle interior and the extender itself.

تلفن شبانه روزی: ۰۲۱-۸۸۶۲۰۸۵

**FarmaSOS.com**

## SRS airbags

The SRS airbags inflate when the vehicle is subjected to certain types of severe impacts that may cause significant injury to the occupants. They work together with the seat belts to help reduce the risk of death or serious injury.

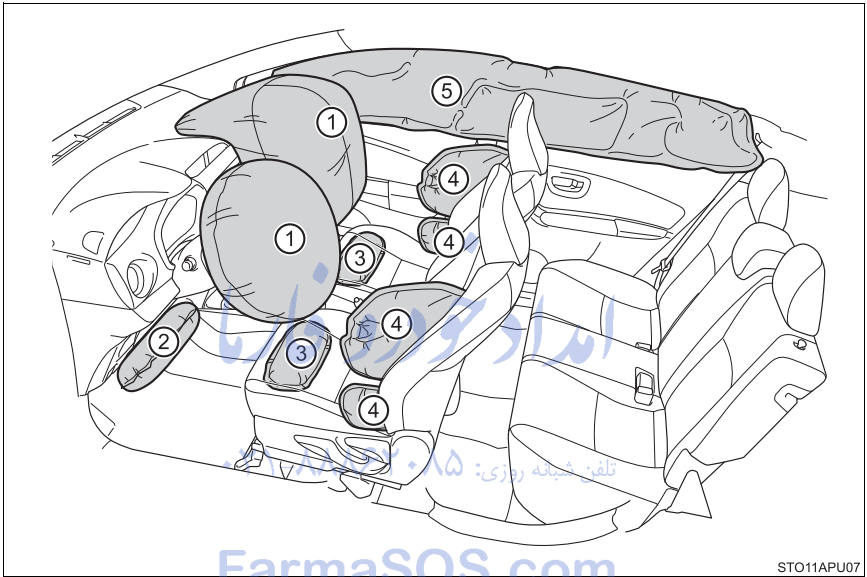

STO11APU07

### ◆ SRS front airbags

- ① SRS driver airbag/front passenger airbag  
Can help protect the head and chest of the driver and front passenger from impact with interior components
- ② SRS driver knee airbag  
Can help provide driver protection
- ③ SRS seat cushion airbags  
Can help restrain the driver and front passenger

### ◆ SRS side and curtain shield airbags

- ④ SRS side airbags  
Can help protect the torso of the front seat occupants
- ⑤ SRS curtain shield airbags  
Can help protect primarily the head of occupants in the outer seats

## SRS airbag system components

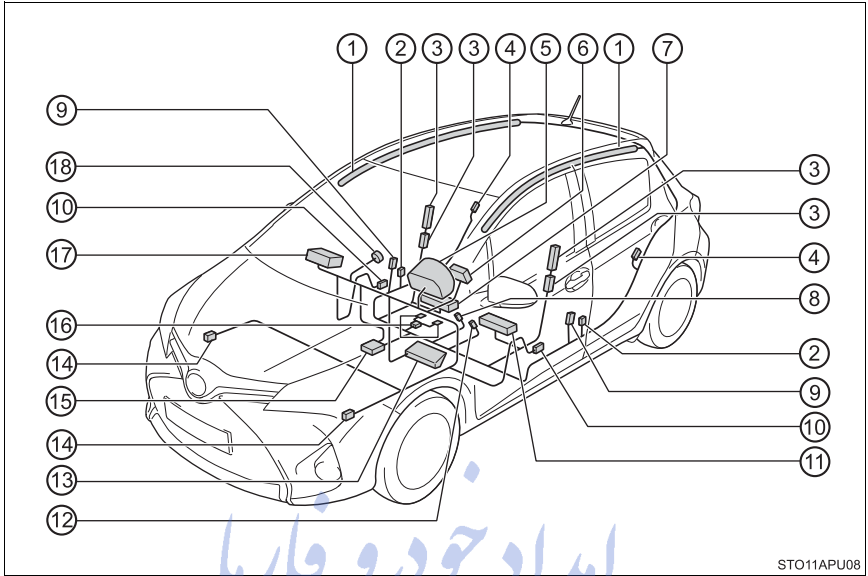

- |  |  |
|--|--|
| ① Curtain shield airbags                     | ⑪ Driver seat cushion airbag                                       |
| ② Side impact sensors (front)                | ⑫ Driver's seat belt buckle switch                                 |
| ③ Side airbags                               | ⑬ Driver knee airbag   |
| ④ Side impact sensors (rear)                 | ⑭ Front impact sensors   |
| ⑤ SRS warning light                          | ⑮ Airbag sensor assembly   |
| ⑥ Driver airbag                              | ⑯ Front passenger occupant classification system (ECU and sensors) |
| ⑦ Passenger seat cushion airbag              | ⑰ Front passenger airbag   |
| ⑧ Front passenger's seat belt buckle switch  | ⑱ "AIR BAG ON" and "AIR BAG OFF" indicator lights                  |
| ⑨ Seat belt pretensioners and force limiters |  |
| ⑩ Side impact sensors (front door)           |  |

Your vehicle is equipped with ADVANCED AIRBAGS designed based on the US motor vehicle safety standards (FMVSS208). The airbag sensor assembly (ECU) controls airbag deployment based on information obtained from the sensors, etc. shown in the system components diagram above. This information includes crash severity and occupant information. As the airbags deploy, a chemical reaction in the inflators quickly fills the airbags with non-toxic gas to help restrain the motion of the occupants.

**WARNING****■ SRS airbag precautions**

Observe the following precautions regarding the SRS airbags. Failure to do so may cause death or serious injury.

- The driver and all passengers in the vehicle must wear their seat belts properly.

The SRS airbags are supplemental devices to be used with the seat belts.

- The SRS driver airbag deploys with considerable force, and can cause death or serious injury especially if the driver is very close to the airbag.

The National Highway Traffic Safety Administration (NHTSA) advises:

Since the risk zone for the driver's airbag is the first 2 - 3 in. (50 - 75 mm) of inflation, placing yourself 10 in. (250 mm) from your driver airbag provides you with a clear margin of safety. This distance is measured from the center of the steering wheel to your breastbone. If you sit less than 10 in. (250 mm) away now, you can change your driving position in several ways:

- Move your seat to the rear as far as you can while still reaching the pedals comfortably.
- Slightly recline the back of the seat. Although vehicle designs vary, many drivers can achieve the 10 in. (250 mm) distance, even with the driver seat all the way forward, simply by reclining the back of the seat somewhat. If reclining the back of your seat makes it hard to see the road, raise yourself by using a firm, non-slippery cushion, or raise the seat if your vehicle has that feature.
- If your steering wheel is adjustable, tilt it downward. This points the airbag toward your chest instead of your head and neck.

The seat should be adjusted as recommended by NHTSA above, while still maintaining control of the foot pedals, steering wheel, and your view of the instrument panel controls.

**⚠ WARNING**

**■ SRS airbag precautions**

- If the seat belt extender has been connected to the front seat belt buckles but the seat belt extender has not also been fastened to the latch plate of the seat belt, the SRS front airbags will judge that the driver and front passenger are wearing the seat belt even though the seat belt has not been connected. In this case, the SRS front airbags may not activate correctly in a collision, resulting in death or serious injury in the event of a collision. Be sure to wear the seat belt with the seat belt extender.
- The SRS front passenger airbag also deploys with considerable force, and can cause death or serious injury especially if the front passenger is very close to the airbag. The front passenger seat should be as far from the airbag as possible with the seatback adjusted, so the front passenger sits upright.
- Improperly seated and/or restrained infants and children can be killed or seriously injured by a deploying airbag. An infant or child who is too small to use a seat belt should be properly secured using a child restraint system. Toyota strongly recommends that all infants and children be placed in the rear seats of the vehicle and properly restrained. The rear seats are safer for infants and children than the front passenger seat. (→P. 53)
- Do not sit on the edge of the seat or lean against the dashboard.

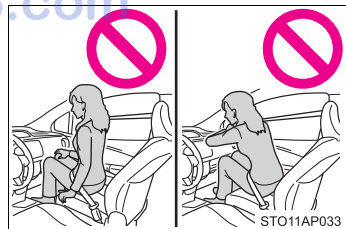

**⚠ WARNING**

**■ SRS airbag precautions**

- Do not allow a child to stand in front of the SRS front passenger airbag unit or sit on the knees of a front passenger.
- Do not allow the front seat occupants to hold items on their knees.

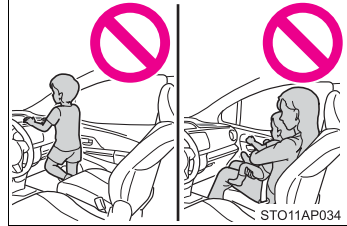

- Do not lean against the door, the roof side rail or the front, side and rear pillars.

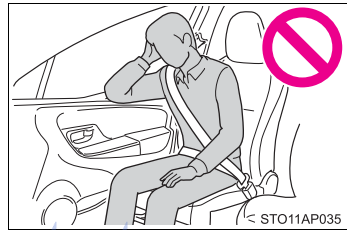

- Do not allow anyone to kneel on the passenger seat toward the door or put their head or hands outside the vehicle.

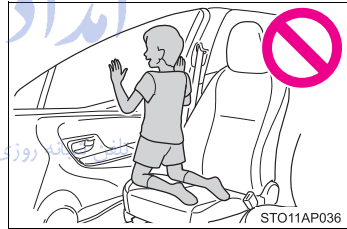

- Do not attach anything to or lean anything against areas such as the dashboard, steering wheel pad and lower portion of the instrument panel. These items can become projectiles when the SRS driver, front passenger and driver knee airbags deploy.

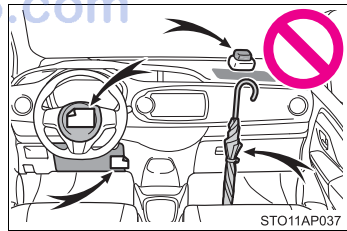

## ⚠ WARNING

### ■ SRS airbag precautions

- Do not attach anything to areas such as a door, windshield glass, side door glass, front or rear pillar, roof side rail and assist grip.

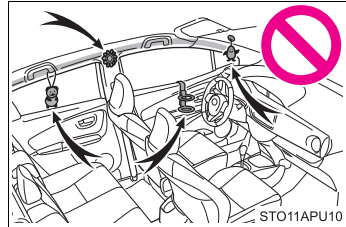

- Do not attach any heavy, sharp or hard objects such as keys and accessories to the key. The objects may restrict the SRS driver knee airbag inflation or be thrust into the driver's seat area by the force of the deploying airbag, thus causing a danger.

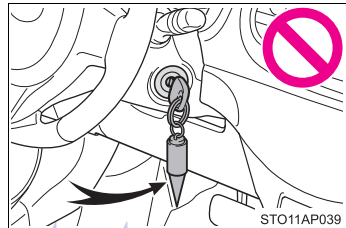

- Do not hang coat hangers or other hard objects on the coat hooks. All of these items could become projectiles and may cause death or serious injury, should the SRS curtain shield airbags deploy.
- If a vinyl cover is put on the area where the SRS driver knee airbag will deploy, be sure to remove it.
- Do not use seat accessories which cover the parts where the SRS side airbags and SRS seat cushion airbags inflate as they may interfere with inflation of the SRS airbags. Such accessories may prevent the side airbags and seat cushion airbags from activating correctly, disable the system or cause the side airbags and seat cushion airbags to inflate accidentally, resulting in death or serious injury.
- Do not strike or apply significant levels of force to the area of the SRS airbag components.  
Doing so can cause the SRS airbags to malfunction.
- Do not touch any of the component parts immediately after the SRS airbags have deployed (inflated) as they may be hot.

**WARNING****■ SRS airbag precautions**

- If breathing becomes difficult after the SRS airbags have deployed, open a door or window to allow fresh air in, or leave the vehicle if it is safe to do so. Wash off any residue as soon as possible to prevent skin irritation.
- If the areas where the SRS airbags are stored, such as the steering wheel pad and front and rear pillar garnishes, are damaged or cracked, have them replaced by your Toyota dealer.
- Do not place anything, such as a cushion, on the front passenger's seat. Doing so will disperse the passenger's weight, which prevents the sensor from detecting the passenger's weight properly. As a result, the SRS front airbags for the front passenger may not deploy in the event of a collision.

**■ Modification and disposal of SRS airbag system components**

Do not dispose of your vehicle or perform any of the following modifications without consulting your Toyota dealer. The SRS airbags may malfunction or deploy (inflate) accidentally, causing death or serious injury.

- Installation, removal, disassembly and repair of the SRS airbags
- Repairs, modifications, removal or replacement of the steering wheel, instrument panel, dashboard, seats or seat upholstery, front, side and rear pillars or roof side rails
- Repairs or modifications of the front fender, front bumper, or side of the occupant compartment
- Installation of a grille guard (bull bars, kangaroo bar, etc.), snow plows, winches
- Modifications to the vehicle's suspension system
- Installation of electronic devices such as mobile two-way radios and CD players
- Modifications to your vehicle for a person with a physical disability.



**■ If the SRS airbags deploy (inflate)**

- Bruising and slight abrasions may result from contact with a deploying (inflating) SRS airbag.
- A loud noise and white powder will be emitted.
- Parts of the airbag module (steering wheel hub, airbag cover and inflator) as well as the front seats, parts of the front and rear pillars, and roof side rails, may be hot for several minutes. The airbag itself may also be hot.
- The windshield may crack.

**■ SRS airbag deployment conditions (SRS front airbags)**

- The SRS front airbags and SRS seat cushion airbags will deploy in the event of an impact that exceeds the set threshold level (the level of force corresponding to an approximately 12 - 18 mph [20 - 30 km/h] frontal collision with a fixed wall that does not move or deform).

However, this threshold velocity will be considerably higher in the following situations:

- If the vehicle strikes an object, such as a parked vehicle or sign pole, which can move or deform on impact
- If the vehicle is involved in an underride collision, such as a collision in which the front of the vehicle “underrides”, or goes under, the bed of a truck

- Depending on the type of collision, it is possible that only the seat belt pretensioners will activate.
- The SRS front airbags and seat cushion airbag for the front passenger will not activate if there is no passenger sitting in the front passenger seat. However, the SRS front airbags and seat cushion airbag for the front passenger may deploy if luggage is put in the seat, even if the seat is unoccupied.
- The SRS seat cushion airbags on the front seats will not operate if the occupant is not wearing a seat belt.

**■ SRS airbag deployment conditions (SRS side and curtain shield airbags)**

The SRS side and curtain shield airbags will deploy in the event of an impact that exceeds the set threshold level (the level of force corresponding to the impact force produced by an approximately 3300 lb. [1500 kg] vehicle colliding with the vehicle cabin from a direction perpendicular to the vehicle orientation at an approximate speed of 12 - 18 mph [20 - 30 km/h]).

### ■ Conditions under which the SRS airbags may deploy (inflate), other than a collision

The SRS front airbags may also deploy if a serious impact occurs to the underside of your vehicle. Some examples are shown in the illustration.

- Hitting a curb, edge of pavement or hard surface
- Falling into or jumping over a deep hole
- Landing hard or falling

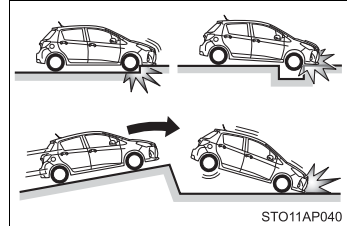

### ■ Types of collisions that may not deploy the SRS airbags (SRS front airbags)

The SRS front airbags and SRS seat cushion airbags do not generally inflate if the vehicle is involved in a side or rear collision, if it rolls over, or if it is involved in a low-speed frontal collision. But, whenever a collision of any type causes sufficient forward deceleration of the vehicle, deployment of the SRS front airbags may occur.

- Collision from the side
- Collision from the rear
- Vehicle rollover

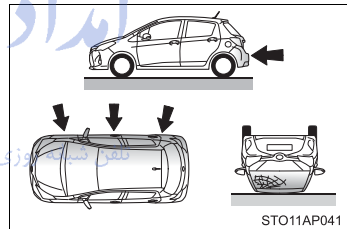

### ■ Types of collisions that may not deploy the SRS airbags (SRS side and curtain shield airbags)

The SRS side and curtain shield airbags may not activate if the vehicle is subjected to a collision from the side at certain angles, or a collision to the side of the vehicle body other than the passenger compartment.

- Collision from the side to the vehicle body other than the passenger compartment
- Collision from the side at an angle

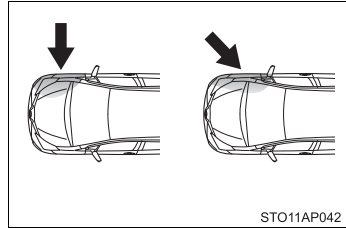

The SRS side and curtain shield airbags do not generally inflate if the vehicle is involved in a frontal or rear collision, if it rolls over, or if it is involved in a low-speed side collision.

- Collision from the front
- Collision from the rear
- Vehicle rollover

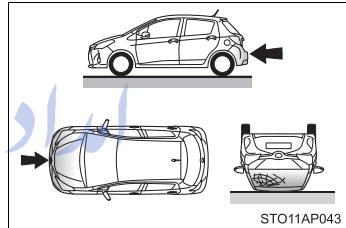

تلفن شبانه روزی: ۰۲۱-۸۸۶۲۰۸۵

FarmaSOS.com

### ■ When to contact your Toyota dealer

In the following cases, the vehicle will require inspection and/or repair. Contact your Toyota dealer as soon as possible.

- Any of the SRS airbags have been inflated.
- The front of the vehicle is damaged or deformed, or was involved in an accident that was not severe enough to cause the SRS front airbags and SRS seat cushion airbags to inflate.

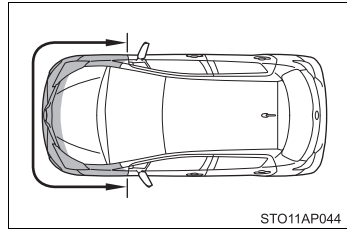

- A portion of a door is damaged or deformed, or the vehicle was involved in an accident that was not severe enough to cause the SRS side and curtain shield airbags to inflate.

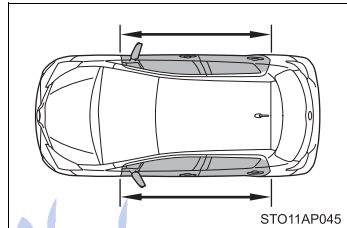

- The pad section of the steering wheel, dashboard near the front passenger airbag or lower portion of the instrument panel is scratched, cracked, or otherwise damaged.

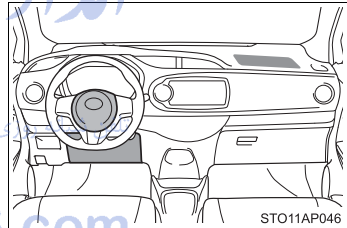

- The front seat cushion surface is scratched, cracked, or otherwise damaged.

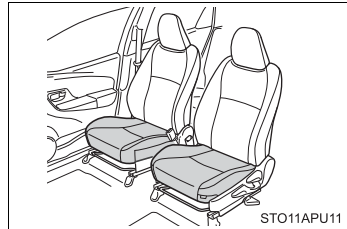

- The surface of the seats with the side airbag is scratched, cracked, or otherwise damaged.

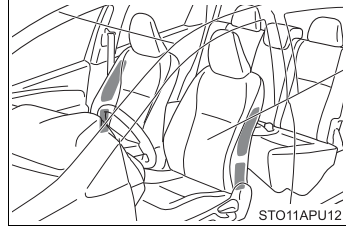

- The portion of the front pillars, rear pillars or roof side rail garnishes (padding), containing the curtain shield airbags inside, is scratched, cracked, or otherwise damaged.

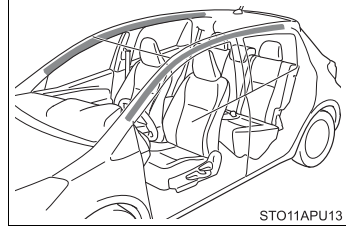

# امداد خودرو فارما

تلفن شبانه روزی: ۰۲۱-۸۸۸۶۲۰۸۵

[FarmaSOS.com](http://FarmaSOS.com)

## Front passenger occupant classification system

Your vehicle is equipped with a front passenger occupant classification system. This system detects the conditions of the front passenger seat and activates or deactivates the devices for front passenger.

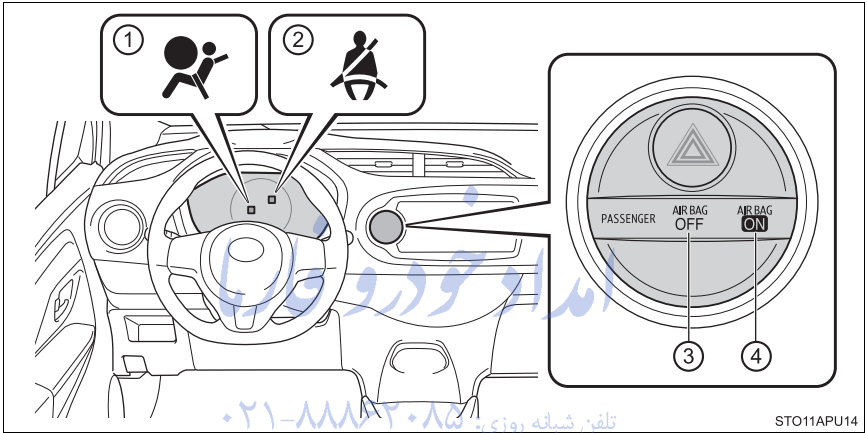

- ① SRS warning light
- ② Seat belt reminder light
- ③ "AIR BAG OFF" indicator light
- ④ "AIR BAG ON" indicator light

## Conditions and operations in the front passenger occupant classification system

### ■ Adult\*1

Indicator/ warning light	“AIR BAG ON” and “AIR BAG OFF” indicator lights	“AIR BAG ON”
	SRS warning light	Off
	Seat belt reminder light	Off*2 or flashing*3
Devices	Front passenger airbag	Activated
	Side airbag on the front passenger seat	
	Curtain shield airbag in the front passenger side	Activated*2 or deactivated*3
	Seat cushion airbag in the front passenger side	
	Front passenger's seat belt pretensioner	

### ■ Child\*4

تلفن شبانه روزی: ۰۲۱-۸۸۶۲۰۸۵

Indicator/ warning light	“AIR BAG ON” and “AIR BAG OFF” indicator lights	“AIR BAG OFF” or “AIR BAG ON”*4
	SRS warning light	Off
	Seat belt reminder light	Off*2 or flashing*3
Devices	Front passenger airbag	Deactivated or activated*4
	Side airbag on the front passenger seat	Activated
	Curtain shield airbag in the front passenger side	
	Seat cushion airbag in the front passenger side	Deactivated or activated*2,4
	Front passenger's seat belt pretensioner	Activated

### ■ Child restraint system with infant\*5

Indicator/ warning light	“AIR BAG ON” and “AIR BAG OFF” indicator lights	“AIR BAG OFF”*6
	SRS warning light	Off
	Seat belt reminder light	Off*2 or flashing*3
Devices	Front passenger airbag	Deactivated
	Side airbag on the front passenger seat	Activated
	Curtain shield airbag in the front passenger side	
	Seat cushion airbag in the front passenger side	Deactivated
	Front passenger’s seat belt pretensioner	Activated

### ■ Unoccupied

Indicator/ warning light	“AIR BAG ON” and “AIR BAG OFF” indicator lights	“AIR BAG OFF”
	SRS warning light	Off
	Seat belt reminder light	
Devices	Front passenger airbag	Deactivated
	Side airbag on the front passenger seat	Activated
	Curtain shield airbag in the front passenger side	
	Seat cushion airbag in the front passenger side	Deactivated
	Front passenger’s seat belt pretensioner	Activated



## ■ There is a malfunction in the system

Indicator/ warning light	“AIR BAG ON” and “AIR BAG OFF” indicator lights	“AIR BAG OFF”
	SRS warning light	On
	Seat belt reminder light	
Devices	Front passenger airbag	Deactivated
	Side airbag on the front passenger seat	Activated
	Curtain shield airbag in the front passenger side	
	Seat cushion airbag in the front passenger side	Deactivated
	Front passenger's seat belt pretensioner	Activated

\*1: The system judges a person of adult size as an adult. When a smaller adult sits in the front passenger seat, the system may not recognize him/her as an adult depending on his/her physique and posture.

\*2: In the event the front passenger is wearing a seat belt.

\*3: In the event the front passenger does not wear a seat belt.

\*4: For some children, child in seat, child in booster seat or child in convertible seat, the system may not recognize him/her as a child. Factors which may affect this can be the physique or posture.

\*5: Never install a rear-facing child restraint system on the front passenger seat. A forward-facing child restraint system should only be installed on the front passenger seat when it is unavoidable. (→P. 53)

\*6: In case the indicator light is not illuminated, consult this manual on how to install the child restraint system properly. (→P. 57)

**WARNING****Front passenger occupant classification system precautions**

Observe the following precautions regarding the front passenger occupant classification system.

Failure to do so may cause death or serious injury.

- Wear the seat belt properly.
- Make sure the front passenger's seat belt plate has not been left inserted into the buckle before someone sits in the front passenger seat.
- Make sure the "AIR BAG OFF" indicator light is not illuminated when using the seat belt extender for the front passenger seat. If the "AIR BAG OFF" indicator light is illuminated, disconnect the extender tongue from the seat belt buckle, and reconnect the seat belt. Reconnect the seat belt extender after making sure the "AIR BAG ON" indicator light is illuminated. If you use the seat belt extender while the "AIR BAG OFF" indicator light is illuminated, the SRS airbags for the passenger may not activate correctly, which could cause death or serious injury in the event of collision.
- Do not apply a heavy load to the front passenger seat or equipment (e.g. seatback pocket).
- Do not put weight on the front passenger seat by putting your hands or feet on the front passenger seat seatback from the rear passenger seat.
- Do not let a rear passenger lift the front passenger seat with their feet or press on the seatback with their legs.
- Do not put objects under the front passenger seat.
- Do not recline the front passenger seatback so far that it touches a rear seat. This may cause the "AIR BAG OFF" indicator light to be illuminated, which indicates that the passenger's airbags will not deploy in the event of a severe accident. If the seatback touches the rear seat, return the seatback to a position where it does not touch the rear seat. Keep the front passenger seatback as upright as possible when the vehicle is moving. Reclining the seatback excessively may lessen the effectiveness of the seat belt system.

**WARNING****Front passenger occupant classification system precautions**

- If an adult sits in the front passenger seat, the “AIR BAG ON” indicator light is illuminated. If the “AIR BAG OFF” indicator is illuminated, ask the passenger to sit up straight, well back in the seat, feet on the floor, and with the seat belt worn correctly. If the “AIR BAG OFF” indicator still remains illuminated, either ask the passenger to move to the rear seat, or if that is not possible, move the front passenger seat fully rearward.
- When it is unavoidable to install a forward-facing child restraint system on the front passenger seat, install the child restraint system on the front passenger seat in the proper order. (→P. 57)
- Do not modify or remove the front seats.
- Do not kick the front passenger seat or subject it to severe impact. Otherwise, the SRS warning light may come on to indicate a malfunction of the detection system. In this case, contact your Toyota dealer immediately.
- Child restraint systems installed on the rear seat should not contact the front seatbacks.
- Do not use a seat accessory, such as a cushion and seat cover, that covers the seat cushion surface.
- Do not modify or replace the upholstery of the front seat.

تلفن شبانه روزی: ۰۲۱-۸۸۶۲۰۸۵

FarmaSOS.com

## Safety information for children

**Observe the following precautions when children are in the vehicle.**

**Use a child restraint system appropriate for the child, until the child becomes large enough to properly wear the vehicle's seat belt.**

- It is recommended that children sit in the rear seats to avoid accidental contact with the shift lever, wiper switch, etc.
- Use the rear door child-protector lock or the window lock switch to avoid children opening the door while driving or operating the power window accidentally.
- Do not let small children operate equipment which may catch or pinch body parts, such as the power window, hood, back door, seats, etc.



### WARNING

Never leave children unattended in the vehicle, and never allow children to have or use the key. تلفن شبانه روزی: ۰۸۵۲۰۸۶۲-۲۱

Children may be able to start the vehicle or shift the vehicle into neutral. There is also a danger that children may injure themselves by playing with the cigarette lighter, the windows or other features of the vehicle. In addition, heat build-up or extremely cold temperatures inside the vehicle can be fatal to children.

## Child restraint systems

**A child restraint system for a small child or baby must itself be properly restrained on the seat with the lap portion of the lap/shoulder belt.**

**The laws of all 50 states of the U.S.A. and Canada now require the use of child restraint systems.**

### Points to remember

Studies have shown that installing a child restraint on a rear seat is much safer than installing one on the front passenger seat.

- Choose a child restraint system that suits your vehicle and is appropriate to the age and size of the child.
- For installation details, follow the instructions provided with the child restraint system.

General installation instructions are provided in this manual.

(→P. 57)

تلفن شبانه روزی: ۰۲۱-۸۸۶۲۰۸۵

FarmaSOS.com

## Types of child restraints

Child restraint systems are classified into the following 3 types according to the age and size of the child:

▶ Rear facing — Infant seat/  
convertible seat

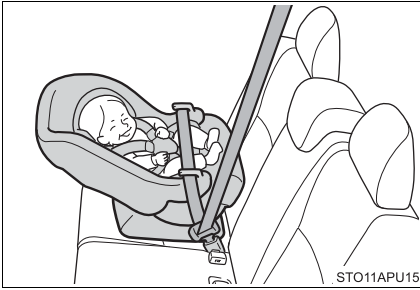

▶ Forward facing — Convertible  
seat



▶ Booster seat

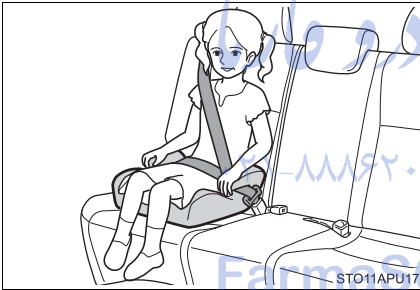

### ■ Selecting an appropriate child restraint system

- Use a child restraint system appropriate for the child until the child becomes large enough to properly wear the vehicle's seat belt.
- If the child is too large for a child restraint system, sit the child on a rear seat and use the vehicle's seat belt. (→P. 26)

 **WARNING****■ Child restraint precautions**

- For effective protection in automobile accidents and sudden stops, a child must be properly restrained, using a seat belt or child restraint system depending on the age and size of the child. Holding a child in your arms is not a substitute for a child restraint system. In an accident, the child can be crushed against the windshield, or between you and the vehicle's interior.
- Toyota strongly urges the use of a proper child restraint system that conforms to the size of the child, installed on the rear seat. According to accident statistics, the child is safer when properly restrained in the rear seat than in the front seat.
- Never install a rear-facing child restraint system on the front passenger seat even if the "AIR BAG OFF" indicator light is illuminated. In the event of an accident, the force of the rapid inflation of the front passenger airbag can cause death or serious injury to the child if the rear-facing child restraint system is installed on the front passenger seat.
- A forward-facing child restraint system may be installed on the front passenger seat only when it is unavoidable. A child restraint system that requires a top tether strap should not be used in the front passenger seat since there is no top tether strap anchor for the front passenger seat. Adjust the seatback as upright as possible and always move the seat as far back as possible even if the "AIR BAG OFF" indicator light is illuminated, because the front passenger airbag could inflate with considerable speed and force. Otherwise, the child may be killed or seriously injured.
- Do not use the seat belt extender when installing a child restraint system on the front or rear passenger seat. If installing a child restraint system with the seat belt extender connected to the seat belt, the seat belt will not securely hold the child restraint system, which could cause death or serious injury to the child or other passengers in the event of sudden braking, sudden swerving or an accident.

**WARNING****■ Child restraint precautions**

- Do not allow the child to lean his/her head or any part of his/her body against the door or the area of the seat, front and rear pillars or roof side rails from which the SRS side airbags or SRS curtain shield airbags deploy even if the child is seated in the child restraint system. It is dangerous if the SRS side airbags and curtain shield airbags inflate, and the impact could cause death or serious injury to the child.
- Make sure you have complied with all installation instructions provided by the child restraint manufacturer and that the system is properly secured. If it is not secured properly, it may cause death or serious injury to the child in the event of a sudden stop, sudden swerve or an accident.

**■ When children are in the vehicle**

Do not allow children to play with the seat belt. If the seat belt becomes twisted around a child's neck, it may lead to choking or other serious injuries that could result in death.

If this occurs and the buckle cannot be unfastened, scissors should be used to cut the belt.

**■ When the child restraint system is not in use**

- Keep the child restraint system properly secured on the seat even if it is not in use. Do not store the child restraint system unsecured in the passenger compartment.
- If it is necessary to detach the child restraint system, remove it from the vehicle or store it securely in the luggage compartment. This will prevent it from injuring passengers in the event of a sudden stop, sudden swerve or an accident.



## Installing child restraints

**Follow the child restraint system manufacturer's instructions. Firmly secure child restraints to the rear seats using the LATCH anchors or a seat belt. Attach the top tether strap when installing a child restraint.**

**The lap/shoulder belt can be used if your child restraint system is not compatible with the LATCH (Lower Anchors and Tethers for Children) system.**

### Child restraint LATCH anchors

LATCH anchors are provided for the rear outer seats. (Buttons displaying the location of the anchors are attached to the seats.)

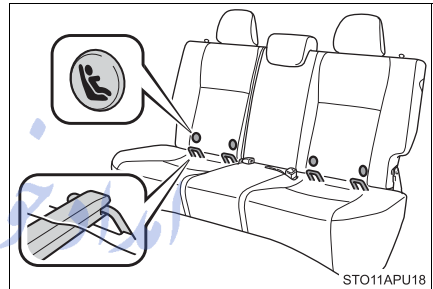

Seat belts equipped with a child restraint locking mechanism (ALR/ELR belts except driver's seat belt) (→P. 26)



### Anchor brackets (for top tether strap)

An anchor bracket is provided for the each rear seats.

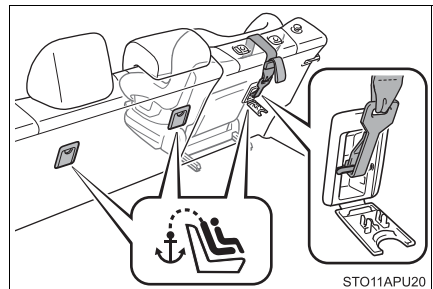

## Installation with LATCH system

### ► Type A

- 1 Widen the gap between the seat cushion and seatback slightly.
- 2 Latch the hooks of the lower straps onto the LATCH anchors. If the child restraint has a top tether strap, the top tether strap should be latched onto the top tether strap anchor.

For owners in Canada:

The symbol on a child restraint system indicates the presence of a lower connector system.

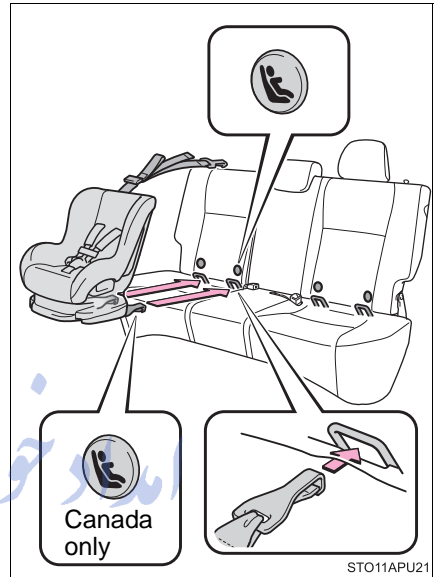

### ► Type B

- 1 Widen the gap between the seat cushion and seatback slightly.
- 2 Latch the buckles onto the LATCH anchors. If the child restraint has a top tether strap, the top tether strap should be latched onto the top tether strap anchor.

For owners in Canada:

The symbol on a child restraint system indicates the presence of a lower connector system.

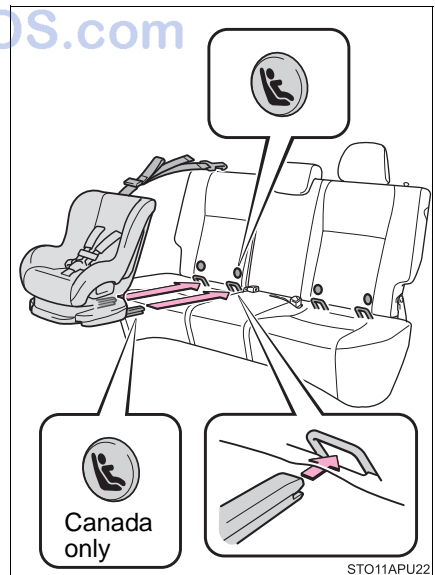

## Installing child restraints using a seat belt (child restraint lock function belt)

### ■ Rear-facing — Infant seat/convertible seat

- 1 Place the child restraint system on the rear seat facing the rear of the vehicle.

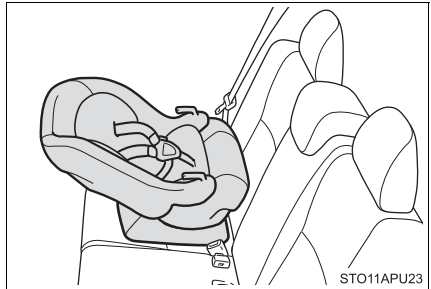

- 2 Run the seat belt through the child restraint system and insert the plate into the buckle. Make sure that the belt is not twisted.

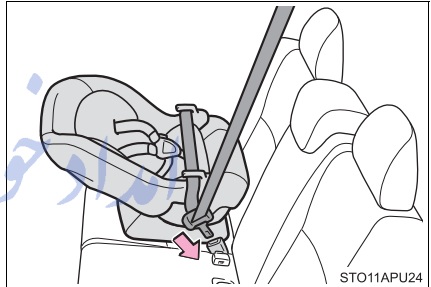

- 3 Fully extend the shoulder belt and allow it to retract to put it in lock mode. In lock mode, the belt cannot be extended.

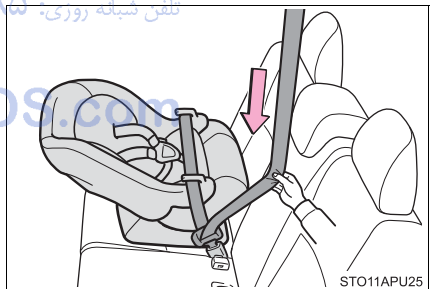

- 4 While pushing the child restraint system down into the rear seat, allow the shoulder belt to retract until the child restraint system is securely in place.

After the shoulder belt has retracted to a point where there is no slack in the belt, pull the belt to check that it cannot be extended.

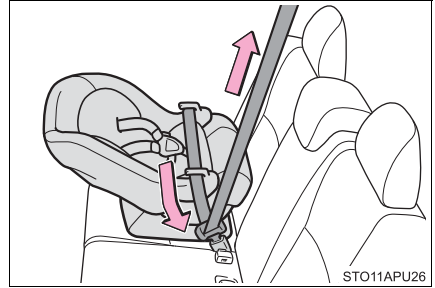

### ■ Forward-facing — Convertible seat

- 1 Remove the head restraint. (→P. 104)
- 2 Place the child restraint system on the seat facing the front of the vehicle.

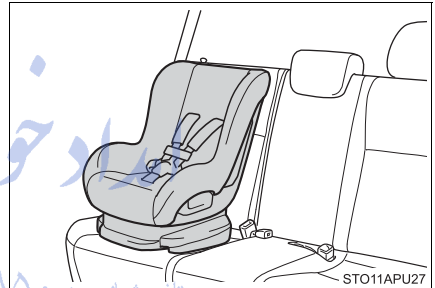

- 3 Run the seat belt through the child restraint system and insert the plate into the buckle. Make sure that the belt is not twisted.

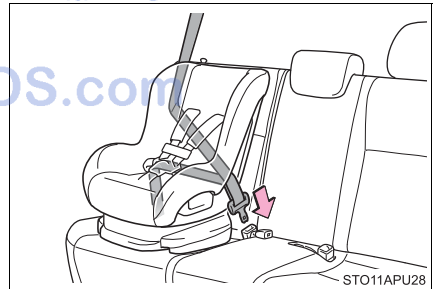

- 4 Fully extend the shoulder belt and allow it to retract to put it in lock mode. In lock mode, the belt cannot be extended.

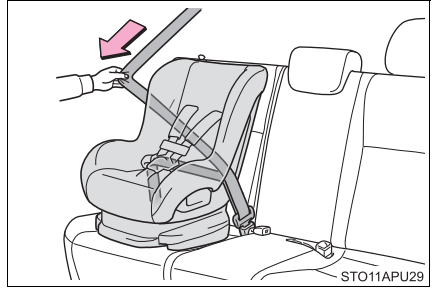

- 5 While pushing the child restraint system into the rear seat, allow the shoulder belt to retract until the child restraint system is securely in place.

After the shoulder belt has retracted to a point where there is no slack in the belt, pull the belt to check that it cannot be extended.

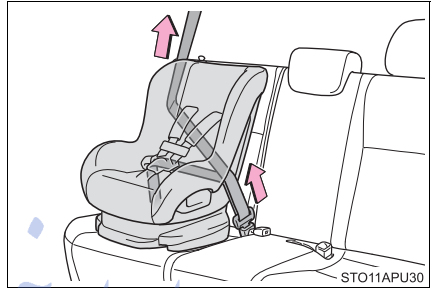

- 6 If the child restraint has a top tether strap, the top tether strap should be latched onto the top tether strap anchor. (→P. 63)

تلفن شبانه روزی: ۰۲۱-۸۸۶۲۰۸۵

FarmaSOS.com

## ■ Booster seat

- 1 Place the child restraint system on the seat facing the front of the vehicle.

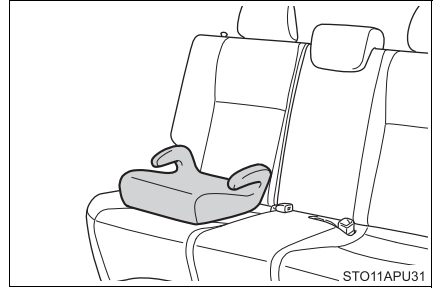

- 2 Sit the child in the child restraint system. Fit the seat belt to the child restraint system according to the manufacturer's instructions and insert the plate into the buckle. Make sure that the belt is not twisted.



Check that the shoulder belt is correctly positioned over the child's shoulder and that the lap belt is as low as possible. (→P. 26)

## Removing a child restraint installed with a seat belt

Push the buckle release button and fully retract the seat belt.

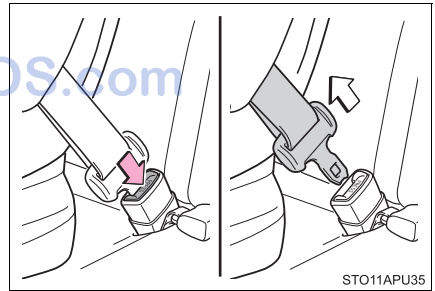

## Child restraint systems with a top tether strap

- 1 Remove the luggage cover. (→P. 188)
- 2 Remove the head restraint. (→P. 104)
- 3 Secure the child restraint system using the LATCH anchors or a seat belt.
- 4 Open the anchor bracket cover, latch the hook onto the anchor bracket and tighten the top tether strap.  
Make sure the top tether strap is securely latched.

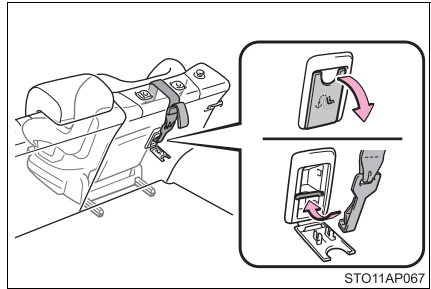

- 5 Reinstall the luggage cover.

### ■ Laws and regulations pertaining to anchorages

The LATCH system conforms to FMVSS225 or CMVSS210.2.

Child restraint systems conforming to FMVSS213 or CMVSS213 specifications can be used.

This vehicle is designed to conform to the SAE J1819.

تلفن شبانه روزی: ۰۲۱-۸۸۶۳۰۸۵

FarmaSOS.com

**⚠ WARNING**

■ **When installing a booster seat**

To prevent the belt from going into ALR lock mode, do not fully extend the shoulder belt. ALR mode causes the belt to tighten only. This could cause injury or discomfort to the child. (→P. 29)

■ **When installing a child restraint system**

Follow the directions given in the child restraint system installation manual and fix the child restraint system securely in place.

If the child restraint system is not correctly fixed in place, the child or other passengers may be seriously injured or even killed in the event of a sudden braking, sudden swerving or an accident.

- If the driver's seat interferes with the child restraint system and prevents it from being attached correctly, attach the child restraint system to the rear right seat.
- Adjust the front passenger seat so that it does not interfere with the child restraint system.

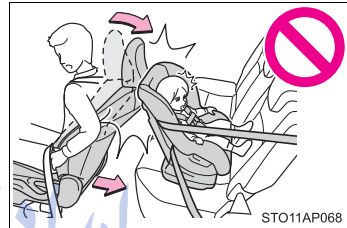

STO11AP068

- Only put a forward-facing child restraint system on the front passenger seat when unavoidable.

When installing a forward-facing child restraint system on the front passenger seat, move the seat as far back as possible even if the "AIR BAG OFF" indicator light is illuminated.

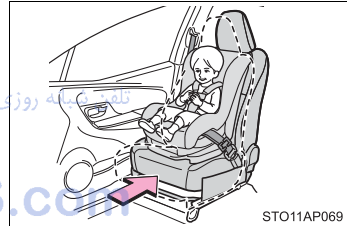

STO11AP069

Failure to do so may result in death or serious injury if the airbags deploy (inflate).

- When a booster seat is installed, always ensure that the shoulder belt is positioned across the center of the child's shoulder. The belt should be kept away from the child's neck, but not so that it could fall off the child's shoulder. Failure to do so may result in death or serious injury in the event of a sudden braking, sudden swerving or an accident.



## WARNING

### ■ When installing a child restraint system

- Ensure that the belt and plate are securely locked and the seat belt is not twisted.
- Shake the child restraint system left and right, and forward and backward to ensure that it has been securely installed.
- After securing a child restraint system, never adjust the seat.
- Follow all installation instructions provided by the child restraint system manufacturer.
- When a child restraint system with a top tether strap is installed, do not install the head restraint. The head restraint may interfere with the top tether strap preventing secure installation of the child restraint system.
- Make sure to properly store the removed head restraint in a secure place when you use the child restraint system on the rear seat.
- When using the rear right seat for the child restraint system, do not sit in the rear center seat. Seat belt function may be impaired, such as being positioned overly high or loose-fitting, which may result in death or serious injury in the event of sudden braking or an accident.



### ■ Do not use a seat belt extender

If a seat belt extender is used when installing a child restraint system, the seat belt will not securely hold the child restraint system, which could cause death or serious injury to the child or other passengers in the event of sudden braking, sudden swerving or an accident.

### ■ To correctly attach a child restraint system to the anchors

When using the LATCH anchors, be sure that there are no foreign objects around the anchors and that the seat belt is not caught behind the child restraint system. Make sure the child restraint system is securely attached, or it may cause death or serious injury to the child or other passengers in the event of a sudden braking, sudden swerve or an accident.

تلفن شبانه روزی: ۰۲۱-۸۸۶۲۰۸۵

## Exhaust gas precautions

**Harmful substances to the human body are included in exhaust gases if inhaled.**

### WARNING

Exhaust gases contain harmful carbon monoxide (CO), which is colorless and odorless. Observe the following precautions.

Failure to do so may cause exhaust gases enter the vehicle and may lead to an accident caused by light-headedness, or may lead to death or a serious health hazard.

#### ■ Important points while driving

- Keep the back door closed.
- If you smell exhaust gases in the vehicle even when the back door is closed, open the windows and have the vehicle inspected at your Toyota dealer as soon as possible.

#### ■ When parking

- If the vehicle is in a poorly ventilated area or a closed area, such as a garage, stop the engine.
- Do not leave the vehicle with the engine running for a long time. If such a situation cannot be avoided, park the vehicle in an open space and ensure that exhaust fumes do not enter the vehicle interior.
- Do not leave the engine running in an area with snow build-up, or where it is snowing. If snowbanks build up around the vehicle while the engine is running, exhaust gases may collect and enter the vehicle.

#### ■ Exhaust pipe

The exhaust system needs to be checked periodically. If there is a hole or crack caused by corrosion, damage to a joint or abnormal exhaust noise, be sure to have the vehicle inspected and repaired by your Toyota dealer.

## Engine immobilizer system\*

The vehicle's keys have built-in transponder chips that prevent the engine from starting if a key has not been previously registered in the vehicle's on-board computer.

Never leave the keys inside the vehicle when you leave the vehicle.

This system is designed to help prevent vehicle theft but does not guarantee absolute security against all vehicle thefts.

The system begins operating after the key has been removed from the engine switch. The system is canceled after the registered key has been inserted into the engine switch.

### ■ System maintenance

The vehicle has a maintenance-free type engine immobilizer system.

### ■ Conditions that may cause the system to malfunction

- If the grip portion of the key is in contact with a metallic object
- If the key is in close proximity to or touching a key to the security system (key with a built-in transponder chip) of another vehicle

FarmaSOS.com

\*: If equipped

**■ Certifications for the engine immobilizer system****▶ U.S.A.**

FCC ID: PSIRI-43BTY

This device complies with part 15 of the FCC Rules. Operation is subject to the following two conditions: (1) This device may not cause harmful interference, and (2) this device must accept any interference received, including interference that may cause undesired operation.

**FCC WARNING:**

Changes or modifications not expressly approved by the party responsible for compliance could void the user's authority to operate the equipment.

**▶ Canada**

This device complies with Industry Canada licence-exempt RSS standard(s). Operation is subject to the following two conditions: (1) this device may not cause interference, and (2) this device must accept any interference, including interference that may cause undesired operation of the device.

**NOTICE****■ To ensure the system operates correctly**

Do not modify or remove the system. If modified or removed, the proper operation of the system cannot be guaranteed.

تلفن شبانه روزی: ۰۲۱-۸۸۶۲۰۸۵

**FarmaSOS.com**

## Theft prevention labels (except Canada)

These labels are attached to the vehicle to reduce vehicle theft by facilitating the tracing and recovery of parts from stolen vehicles. Do not remove under penalty of law.

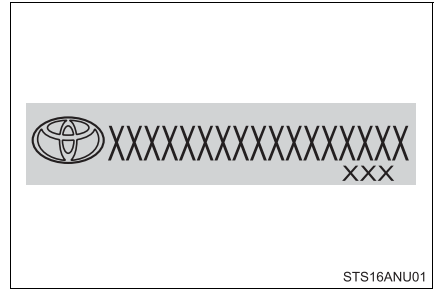

# امداد خودرو فارما

تلفن شبانه روزی: ۰۲۱-۸۸۸۶۲۰۸۵

[FarmaSOS.com](http://FarmaSOS.com)

# امداد خودرو فارما

تلفن شبانه روزی: ۰۲۱-۸۸۸۶۲۰۸۵

**FarmaSOS.com**

**Instrument cluster****2****2. Instrument cluster**

Warning lights and indicators .....	72
Gauges and meters .....	76
Multi-information display .....	78

امداد خودرو فارما

تلفن شبانه روزی: ۰۲۱-۸۸۸۶۲۰۸۵

**FarmaSOS.com**

## Warning lights and indicators

The warning lights and indicators on the instrument cluster, center panel and dashboard inform the driver of the status of the vehicle's various systems.

For the purpose of explanation, the following illustration displays all warning lights and indicators illuminated.

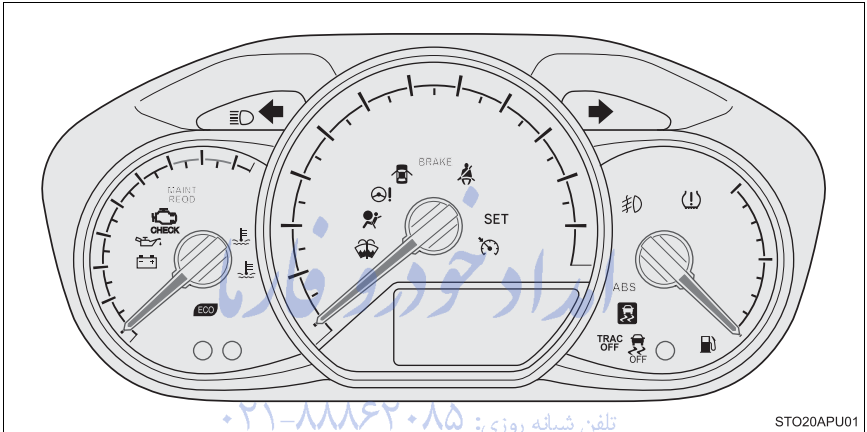



















This illustration represents a meter with a tachometer and may differ from the look of the meter without a tachometer.



## Warning lights













Warning lights inform the driver of malfunctions in the indicated vehicle's systems.

*1  (Except Canada)	Brake system warning light (→P. 272)	*1 	Electric power steering system warning light (→P. 273)
*1  (Canada)	Brake system warning light (→P. 272)	*1, 3 	Slip indicator light (→P. 273)
*1 	Charging system warning light (→P. 272)	*2  (Yellow)	Cruise control indicator light (→P. 274)
*1 	Low engine oil pressure warning light (→P. 272)	*1 	Open door warning light (→P. 274)
*1  (Red)	High engine coolant temperature warning light (→P. 272)		Low fuel level warning light (→P. 274)
*1  (Except Canada)	Malfunction indicator lamp (→P. 273)		Driver's and front passenger's seat belt reminder light (→P. 274)
*1  (Canada)	Malfunction indicator lamp (→P. 273)	*1  (Except Canada)	Tire pressure warning light (→P. 274)
*1 	SRS warning light (→P. 273)	*1  (If equipped)	Low windshield washer fluid warning light (→P. 275)
*1  (Except Canada)	ABS warning light (→P. 273)	*1  (Except Canada)	Maintenance required reminder light (→P. 275)
*1  (Canada)	ABS warning light (→P. 273)		

- \*1: These lights turn on when the engine switch is turned to the "ON" position to indicate that a system check is being performed. They will turn off after the engine is started, or after a few seconds. There may be a malfunction in a system if a light does not come on, or if the lights do not turn off. Have the vehicle inspected by your Toyota dealer.
- \*2: If equipped
- \*3: The light flashes to indicate that the system is operating and come on to indicate a malfunction.

## Indicators

The indicators inform the driver of the operating state of the vehicle's various systems.

	Turn signal indicator (→P. 142)		*2 Cruise control "SET" indicator (→P. 158)
	Headlight high beam indicator (→P. 146)		*1, 5 Slip indicator (→P. 163)
	*2 Front fog light indicator (→P. 147)		*1 "TRAC OFF" indicator (→P. 163)
	*3 Low engine coolant tem- perature indicator (Blue)		*1 VSC OFF indicator (→P. 164)
	*1, 4 Eco Driving Indicator Light (→P. 120)		*1, 6 "AIR BAG ON" indicator (→P. 46)
	*2 Cruise control indicator (→P. 158) (Green)		*1, 6 "AIR BAG OFF" indicator (→P. 46)

- \*1: These lights turn on when the engine switch is turned to the "ON" position to indicate that a system check is being performed. They will turn off after the engine is started, or after a few seconds. There may be a malfunction in a system if a light does not come on, or if the lights do not turn off. Have the vehicle inspected by your Toyota dealer.
- \*2: If equipped
- \*3: The light turns on to indicate the engine coolant temperature is low.
- \*4: Vehicles with an automatic transmission
- \*5: The light flashes to indicate that the system is operating.
- \*6: This light illuminates on the center panel.



### WARNING

#### ■ If a safety system warning light does not come on

Should a safety system light such as the ABS and SRS warning light not come on when you start the engine, this could mean that these systems are not available to help protect you in an accident, which could result in death or serious injury. Have the vehicle inspected by your Toyota dealer immediately if this occurs.



### NOTICE

#### ■ To prevent damage to the engine and its components

The engine may be overheating if the high engine coolant temperature warning light flashes or turns on. In this case, immediately stop the vehicle in a safe place, and check the engine after it has cooled completely. (→P. 300)

## Gauges and meters

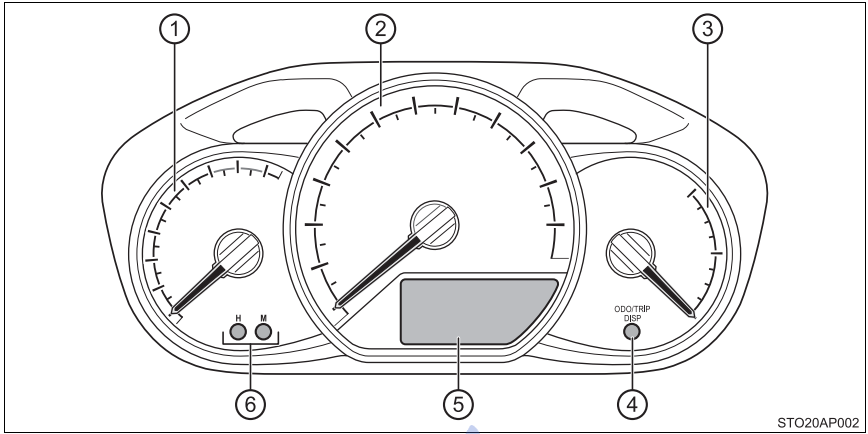

- ① Tachometer (if equipped)  
Displays the engine speed in revolutions per minute.
- ② Speedometer  
Displays the vehicle speed.
- ③ Fuel gauge (if equipped)  
Displays the quantity of fuel remaining in the tank.
- ④ Display change button  
→P. 79
- ⑤ Multi-information display  
Presents the driver with a variety of driving-related data. (→P. 78)
- ⑥ Clock adjusting buttons  
→P. 80

## Instrument panel light control

The brightness of the instrument panel lights can be adjusted.

- ① Brighter
- ② Darker

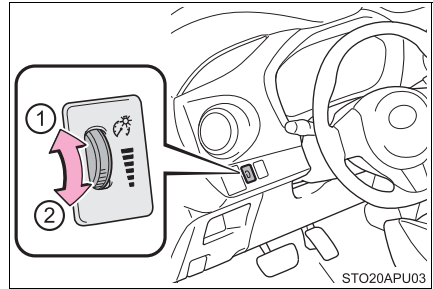

### ■ The meters and display illuminate when

The engine switch is in the “ON” position.



NOTICE

### ■ To prevent damage to the engine and its components

On vehicles with a tachometer, do not let the indicator needle of the tachometer enter the red zone, which indicates the maximum engine speed.

تلفن شبانه روزی: ۰۲۱-۸۸۶۲۰۸۵

FarmaSOS.com

## Multi-information display

The multi-information display presents the driver with a variety of driving-related data including the clock.

### Display contents

#### ► Type A

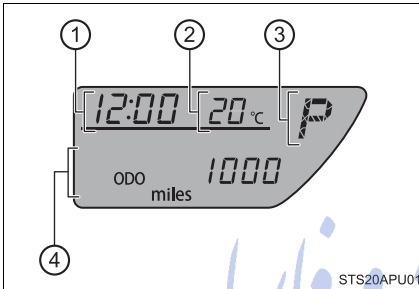

#### ► Type B

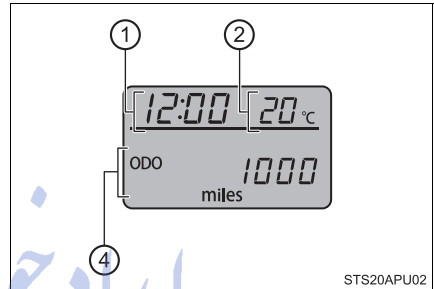

#### ► Type C

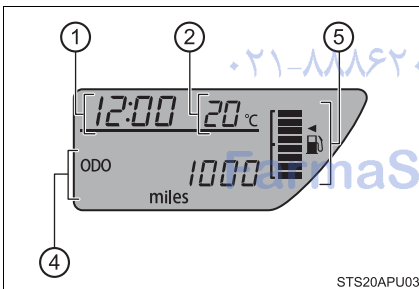

- ① Clock (→P. 80)
- ② Outside temperature display (→P. 81)
- ③ Shift position and gear step position indicator (→P. 139)
- ④ Drive information (→P. 79)
- ⑤ Fuel gauge

## Changing the display

Items displayed can be switched by pressing the display change button.

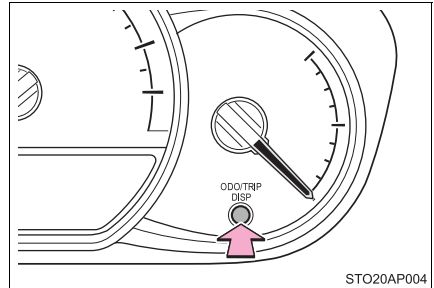

## Drive information

### ■ Odometer

Displays the total distance the vehicle has been driven.

### ■ Trip meters

Displays the distance the vehicle has been driven since the meter was last reset. Trip meters “A” and “B” can be used to record and display different distances independently.

Pressing and holding the display change button while the trip meter is displayed will reset the trip meter to “0”.

### ■ Driving range

Displays the estimated maximum distance that can be driven with the quantity of fuel remaining.

- This distance is computed based on your average fuel consumption. As a result, the actual distance that can be driven may differ from that displayed.
- When only a small amount of fuel is added to the tank, the display may not be updated.

When refueling, turn the engine switch to the “LOCK” position. If the vehicle is refueled without turning the engine switch to the “LOCK” position, the display may not be updated.

### ■ Average fuel consumption

Displays the average fuel consumption since the function was reset.

- The function can be reset by pressing and holding the display change button when the average fuel consumption is displayed.
- Use the displayed average fuel consumption as a reference.

### ■ Instantaneous fuel consumption

Displays the instantaneous of fuel consumption.

### ■ Average vehicle speed

Displays the average vehicle speed since the engine was last started.

## Eco Driving Indicator Light customization (Vehicles with an automatic transmission)

Eco Driving Indicator Light can be activated or deactivated by pressing the display change button when the Eco Driving Indicator Light customization display is displayed.

To change the Eco Driving Indicator Light customization display, display the odometer and press and hold the display change button until the display changes.

After customization, press the display change button for more than 2 seconds to return to the odometer.

## Clock

The clock can be adjusted by pressing the buttons.

- ① Adjust the hours
- ② Adjust the minutes

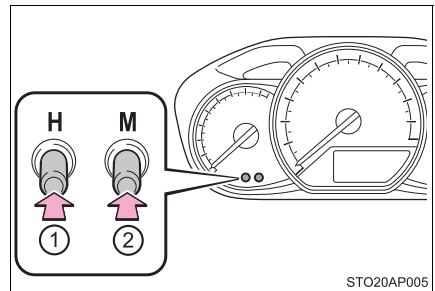



## Outside temperature display

The temperature display shows temperatures within the range of -40°F (-40°C) and 122°F (50°C).

### ■ Display

In the following situations, the correct outside temperature may not be displayed, or the display may take longer than normal to change:

- When the vehicle is stopped, or moving at low speeds (less than 16 mph [25 km/h])
- When the outside temperature has changed suddenly (at the entrance/exit of a garage, tunnel, etc.)

### ■ When “-” or “E” is displayed

The system may be malfunctioning. Take your vehicle to your Toyota dealer.

### ■ When disconnecting and reconnecting battery terminals

The following information data will be reset.

- Driving range
- Average fuel consumption
- Average vehicle speed
- Clock data

### ■ Liquid crystal display

Small spots or light spots may appear on the display. This phenomenon is characteristic of liquid crystal display, and there is no problem continuing to use the display.



#### NOTICE

### ■ The multi-information display at low temperatures

Allow the interior of the vehicle to warm up before using the liquid crystal information display. At extremely low temperatures, the display monitor may respond slowly, and display changes may be delayed.

امداد خودرو فارما

تلفن شبانه روزی: ۰۲۱-۸۸۸۶۲۰۸۵

**FarmaSOS.com**

## Operation of each component

### 3

#### 3-1. Key information

Keys ..... 84

#### 3-2. Opening, closing and locking the doors

Side doors ..... 89

Back door ..... 94

#### 3-3. Adjusting the seats

Front seats ..... 98

Rear seats ..... 101

Head restraints ..... 104

#### 3-4. Adjusting the steering wheel and mirrors

Steering wheel ..... 107

Inside rear view mirror ..... 109

Outside rear view  
mirrors ..... 111

#### 3-5. Opening and closing the windows

Power windows ..... 113

# Keys

## The keys

The following keys are provided with the vehicle.

► Vehicles without an engine immobilizer system (type A)

- ① Master keys
- ② Key number plate

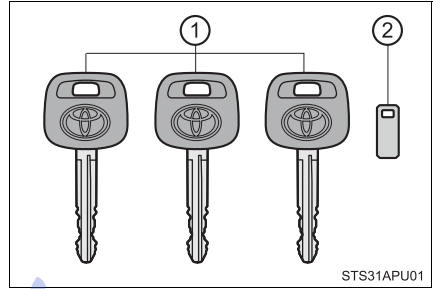

► Vehicles without an engine immobilizer system (type B)

- ① Master key (with a wireless remote control function)  
Operating the wireless remote control function (→P. 89)
- ② Master keys (without a wireless remote control function)
- ③ Key number plate

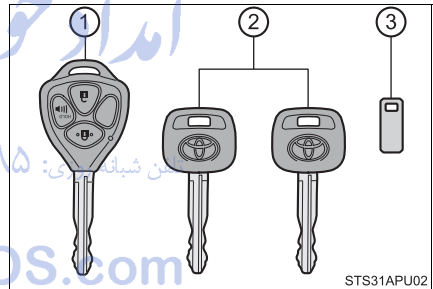

► Vehicles with an engine immobilizer system (type A)

- ① Master keys
- ② Key number plate

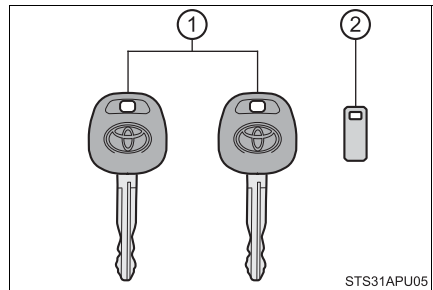

► Vehicles with an engine immobilizer system (type B)

① Master keys

Operating the wireless remote control function (→P. 89)

② Key number plate

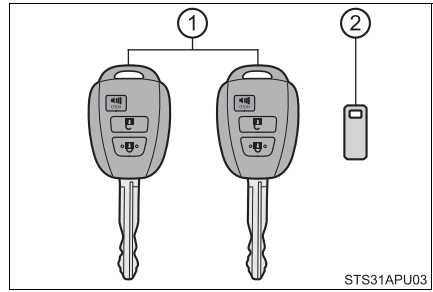

► Vehicles with an engine immobilizer system (type C)

① Master keys

Operating the wireless remote control function (→P. 89)

② Key number plate

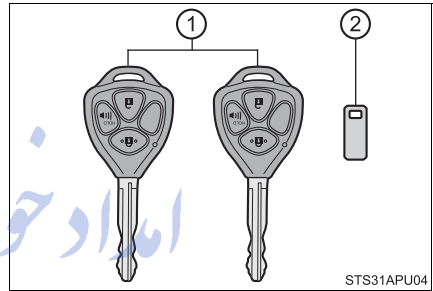

### Wireless remote control (if equipped)

► Type A

① Locks all the doors (→P. 89)

② Sounds the alarm (press and hold)

③ Unlocks all the doors (→P. 89)

Pressing the button unlocks the driver's door. Pressing the button again within 3 seconds unlocks the other doors.

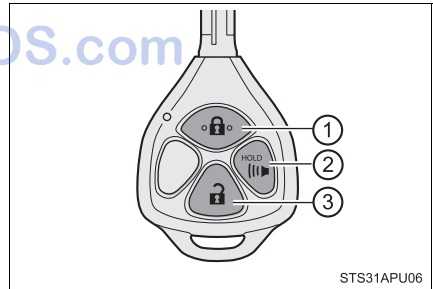

► Type B

- ① Locks all the doors (→P. 89)
- ② Unlocks all the doors (→P. 89)
 

Pressing the button unlocks the driver's door. Pressing the button again within 3 seconds unlocks the other doors.
- ③ Sounds the alarm (press and hold)

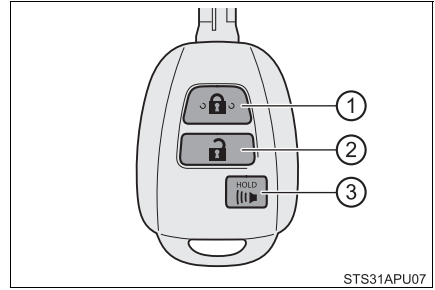

STS31APU07

■ If you lose your keys

New genuine keys can be made by your Toyota dealer using the other key and the key number stamped on your key number plate. Keep the plate in a safe place such as your wallet, not in the vehicle.

■ When riding in an aircraft

When bringing a key with wireless remote control function onto an aircraft, make sure you do not press any buttons on the key while inside the aircraft cabin. If you are carrying a key in your bag etc., ensure that the buttons are not likely to be pressed accidentally. Pressing a button may cause the key to emit radio waves that could interfere with the operation of the aircraft.

■ Panic mode

When <sup>HOLD</sup> (iii) is pressed for longer than about 1 second, an alarm will sound intermittently and the vehicle lights will flash to deter any person from trying to break into or damage your vehicle.

To stop the alarm, press any button on the wireless remote control.



STO31APU01

### ■ Conditions affecting operation (wireless remote control)

The wireless remote control function may not operate normally in the following situations:

- When the wireless key battery is depleted
- Near a TV tower, electric power plant, gas station, radio station, large display, airport or other facility that generates strong radio waves or electrical noise
- When carrying a portable radio, cellular phone or other wireless communication devices
- When the wireless key is in contact with, or is covered by a metallic object
- When other wireless keys (that emit radio waves) are being used nearby
- If window tint with a metallic content or metallic objects are attached to the rear window

### ■ Key battery depletion

If the wireless remote control function does not operate, the battery may be depleted. Replace the battery when necessary.

### ■ Customization that can be configured at your Toyota dealer

Settings (e.g. wireless remote control system) can be changed.  
(Customizable features: →P. 333)

### ■ Certification for the wireless remote control

#### ▶ U.S.A.

FCC ID: HYQ23AAA

FCC ID: HYQ12BBY • ۲۱-۸۸۶۲۰۸۵ تلفن شبانه روزی

#### NOTE:

This device complies with part 15 of the FCC Rules. Operation is subject to the following two conditions: (1) This device may not cause harmful interference, and (2) this device must accept any interference received, including interference that may cause undesired operation.

#### FCC WARNING:

Changes or modifications not expressly approved by the party responsible for compliance could void the user's authority to operate the equipment.

#### ▶ Canada

#### NOTE:

This device complies with Industry Canada licence-exempt RSS standard(s). Operation is subject to the following two conditions: (1) this device may not cause interference, and (2) this device must accept any interference, including interference that may cause undesired operation of the device.

**NOTICE****■ To prevent key damage**

Observe the following:

- Do not subject the keys to strong shocks, expose them to high temperatures by placing them in direct sunlight, or get them wet.
- Do not expose the keys to electromagnetic materials or attach any material that blocks electromagnetic waves to the key surface.
- Do not disassemble the wireless remote control key.

امداد خودرو فارما

تلفن شبانه روزی: ۰۲۱-۸۸۸۶۲۰۸۵

FarmaSOS.com



## Side doors

### Unlocking and locking the doors from the outside

The vehicle can be locked and unlocked using the keys, wireless remote control or door lock switches.

#### ◆ Wireless remote control (if equipped)

##### ► Type A

- ① Locks all the doors
- ② Sounds the alarm (press and hold)
- ③ Unlocks all the doors

Pressing the button unlocks the driver's door. Pressing the button again within 3 seconds unlocks the other doors.

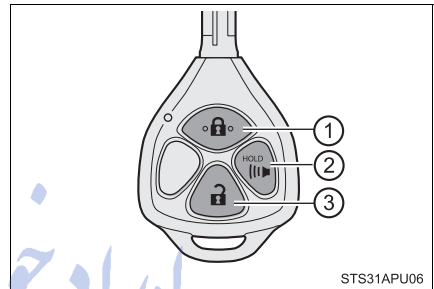

##### ► Type B

- ① Locks all the doors
- ② Unlocks all the doors

Pressing the button unlocks the driver's door. Pressing the button again within 3 seconds unlocks the other doors.

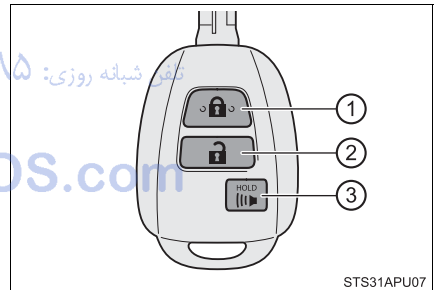

## ◆ Keys

Turning the key operates the doors as follows:

### ■ Driver's door

- ① Locks all the doors
- ② Unlocks all the doors

Turning the key unlocks the driver's door. Turning the key again unlocks the other doors.

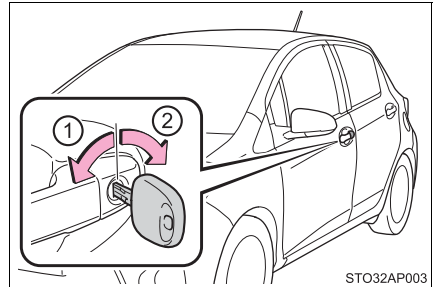

### ■ Front passenger's door

- ① Locks all the doors
- ② Unlocks all the doors

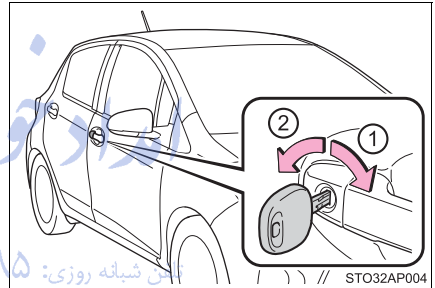

### ■ Operation signals (vehicles with a wireless remote control)

The emergency flashers flash to indicate that the doors have been locked/unlocked. (Locked: once; Unlocked: twice)

### ■ Security feature (vehicles with a wireless remote control)

If a door is not opened within approximately 60 seconds after the vehicle is unlocked, the security feature automatically locks the vehicle again.

## Unlocking and locking the doors from the inside

### ◆ Door lock switch

- ① Unlocks all the doors
- ② Locks all the doors

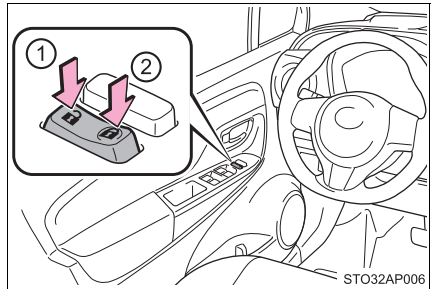

### ◆ Inside door lock buttons

- ① Locks the doors
- ② Unlocks the doors

The front doors can be opened by pulling the inside handle even if the inside door lock button is in the lock position.

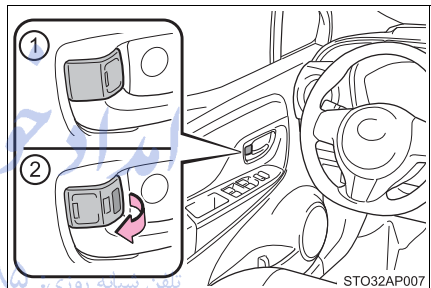

## Locking the front door from the outside without a key

- 1 Move the inside door lock button to the lock position.
- 2 Close the door.

The door cannot be locked if either of the front doors is open and the key is in the engine switch.

### Rear door child-protector lock (5-door models only)

The door cannot be opened from inside the vehicle when the lock is set.

- ① Unlock
- ② Lock

These locks can be set to prevent children from opening the rear doors. Push down on each rear door switch to lock both rear doors.



STO32AP008

#### ■ Conditions affecting the operation of the wireless remote control

→P. 87

#### ■ Customization

تلفن شماره روزی: ۰۲۱-۸۸۶۲۰۸۵

Settings (e.g. unlocking function using a key) can be changed.  
(Customizable features →P. 333)

FarmaSOS.com

**WARNING****■ To prevent an accident**

Observe the following precautions while driving the vehicle.

Failure to do so may result in a door opening and an occupant falling out, resulting in death or serious injury.

- Always use a seat belt.
- Always lock all the doors.
- Ensure that all the doors are properly closed.
- Do not pull the inside handle of the doors while driving.  
The doors may be opened and the passengers are thrown out of the vehicle and it may result in serious injury or death.  
Be especially careful for the front doors, as the doors may be opened even if the inside lock buttons are in locked position.
- Set the rear door child-protector locks when children are seated in the rear seats.

امداد خودرو فارما

تلفن شبانه روزی: ۰۲۱-۸۸۶۲۰۸۵

FarmaSOS.com

## Back door

The back door can be locked/unlocked and opened by the following procedures.

### Unlocking and locking the back door

#### ◆ Door lock switch

→P. 91

#### ◆ Wireless remote control (if equipped)

→P. 89

#### ◆ Keys

From the back door (vehicles with a back door key cylinder):

- ① Unlocks all the doors
- ② Locks all the doors

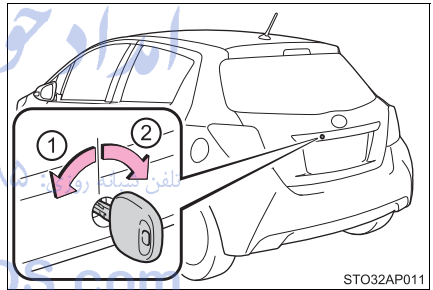

STO32AP011

From the driver's door: →P. 90

### When closing the back door

Lower the back door using the back door handle, and make sure to push the back door down from the outside to close it.

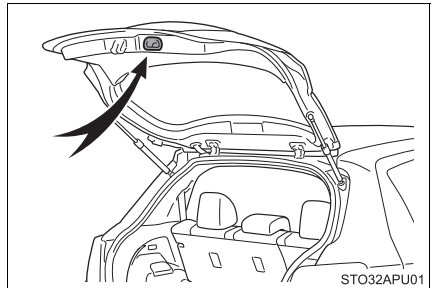

STO32APU01

■ **Operation signals (vehicles with a wireless remote control)**

→P. 90

■ **Security feature (vehicles with a wireless remote control)**

→P. 90

■ **Luggage compartment light**

The luggage compartment lights turn on when the back door is opened.



**WARNING**

Observe the following precautions.

Failure to do so may result in death or serious injury.

■ **Before driving**

- Make sure that the back door is fully closed. If the back door is not fully closed, it may open unexpectedly while driving and hit near-by objects or luggage in the luggage compartment may be thrown out, causing an accident.
- Do not allow children to play in the luggage compartment.  
If a child is accidentally locked in the luggage compartment, they could have heat exhaustion or other injuries.
- Do not allow a child to open or close the back door.  
Doing so may cause the back door to open unexpectedly, or cause the child's hands, head, or neck to be caught by the closing back door.

■ **Important points while driving**

- Keep the back door closed while driving.  
If the back door is left open, it may hit near-by objects or luggage in the luggage compartment may be thrown out, causing an accident.
- Never let anyone sit in the luggage compartment. In the event of sudden braking or a collision, they are susceptible to death or serious injury.

## ⚠ WARNING

### ■ Operating the back door

Observe the following precautions.

Failure to do so may cause parts of the body to be caught, resulting in death or serious injury.

- Remove any heavy loads, such as snow and ice, from the back door before opening it. Failure to do so may cause the back door to suddenly shut again after it is opened.
- When opening or closing the back door, thoroughly check to make sure the surrounding area is safe.
- If anyone is in the vicinity, make sure they are safe and let them know that the back door is about to open or close.
- Use caution when opening or closing the back door in windy weather as it may move abruptly in strong wind.

- The back door may suddenly shut if it is not opened fully. It is more difficult to open or close the back door on an incline than on a level surface, so beware of the back door unexpectedly opening or closing by itself. Make sure that the back door is fully open and secure before using the luggage compartment.

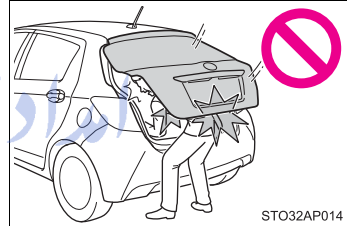

- When closing the back door, take extra care to prevent your fingers, etc., from being caught.
- When closing the back door, make sure to press it lightly on its outer surface. If the back door handle is used to fully close the back door, it may result in hands or arms being caught.

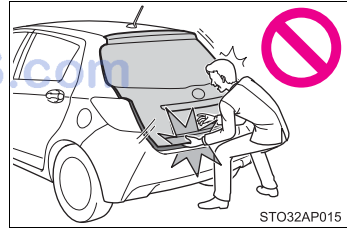

- Do not pull on the back door damper stay to close the back door, and do not hang on the back door damper stay. Doing so may cause hands to be caught or the back door damper stay to break, causing an accident.
- If a bicycle carrier or similar heavy object is attached to the back door, it may suddenly shut again after being opened, causing someone's hands, head or neck to be caught and injured. When installing an accessory part to the back door, using a genuine Toyota part is recommended.



 NOTICE

■ **Back door damper stays**

The back door is equipped with damper stays that hold the back door in place.

Observe the following precautions.

Failure to do so may cause damage to the back door damper stay, resulting in malfunction.

- Do not attach any foreign objects, such as stickers, plastic sheets, or adhesives to the damper stay rod.
- Do not touch the damper stay rod with gloves or other fabric items.
- Do not attach any accessories other than genuine Toyota parts to the back door.
- Do not place your hand on the damper stay or apply lateral forces to it.

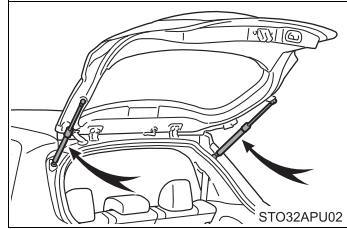

امداد خودرو فارما  
تلفن شبانه روزی: ۰۲۱-۸۸۶۲۰۸۵

FarmaSOS.com

## Front seats

### Adjustment procedure

#### ► Driver's seat

- ① Seat position adjustment lever
- ② Seatback angle adjustment lever
- ③ Vertical height adjustment lever (if equipped)



STS33APU01

#### ► Front passenger's seat

- ① Seat position adjustment lever
- ② Seatback angle adjustment lever
- ③ Seatback lock release lever (3-door models only)

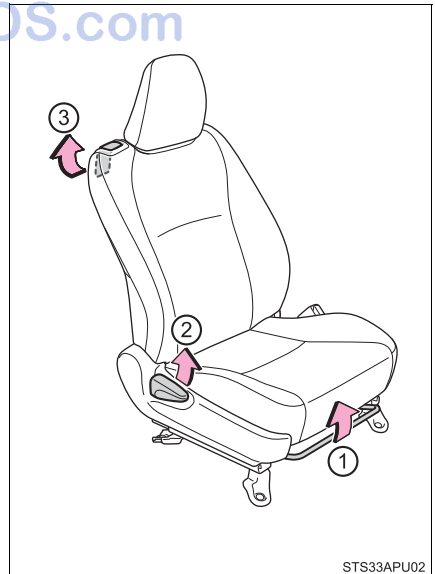

STS33APU02

## Moving front passenger's seat for rear seat entry (3-door models only)

### ■ Getting in or out the vehicle

For easy access to the rear seat, use the seatback lock release lever or seatback angle adjustment lever. When the seatback lock release lever or seatback angle adjustment lever is used, the seat's original position is memorized, so the seat may be returned to that original position. The seatback will be returned to the fully upright position.

Lift the seatback lock release lever or seatback angle adjustment lever.

The seatback will fold forward, and the seat's slide lock will be released.

Move the seat all the way forward.

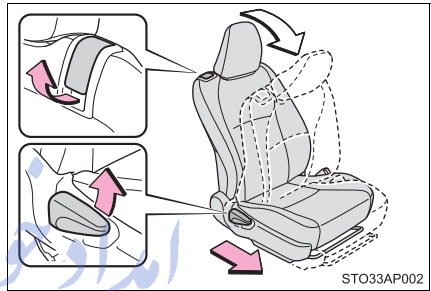

### ■ Seat slide position memory function (3-door models only)

Slide the seat backward and then lift the seatback. The seat will be set and locked to its previous slide position automatically, and the seatback will be returned to the fully upright position.

In the following situations, the seat slide position memory will not be saved or will be overwritten.

- The seatback is lifted upright at a slide position farther forward than the memorized position.
- The seat slide position is memorized when the seat is slid all the way or nearly all the way forward.
- The seat is slid farther back than the memorized position by using the seat position adjustment lever.

### ■ If the seat cannot be returned to the memorized slide position

Lift the seatback lock release lever or seatback angle adjustment lever after removing the luggage, or after having the passenger get out or sit properly so that the seat can be slid back to the previous position.

 **WARNING****■ When adjusting the seat position**

- Take care when adjusting the seat position to ensure that other passengers are not injured by the moving seat.
- Do not put your hands under the seat or near the moving parts to avoid injury.  
Fingers or hands may become jammed in the seat mechanism.

**■ Seat adjustment**

- Be careful that the seat does not hit passenger or luggage.
- To reduce the risk of sliding under the lap belt during a collision, do not recline the seat more than necessary.  
If the seat is too reclined, the lap belt may slide past the hips and apply restraint forces directly to the abdomen, or your neck may contact the shoulder belt, increasing the risk of death or serious injury in the event of an accident.  
Adjustments should not be made while driving as the seat may unexpectedly move and cause the driver to lose control of the vehicle.
- After adjusting the seat, make sure that the seat is locked in position.
- Never allow anyone to touch seatback lock release levers while the vehicle is moving.
- If anyone is in the vicinity, make sure they are clear of the seat back path and let them know that the seat is about to move.

**■ After returning the seatback to the upright position**

Make sure the seatback is securely locked by pushing it forward and rearward. Failure to do so may result in death or serious injury.

 **NOTICE****■ To prevent the seat lock mechanism malfunction**

Do not use the seatback angle adjustment lever and seatback lock release lever at the same time. If they are used together, the seat lock mechanism may be damaged.

## Rear seats

The seatbacks of the rear seats can be folded down.

### Folding down the rear seatbacks

- 1 Stow the rear seat belt buckles as shown.

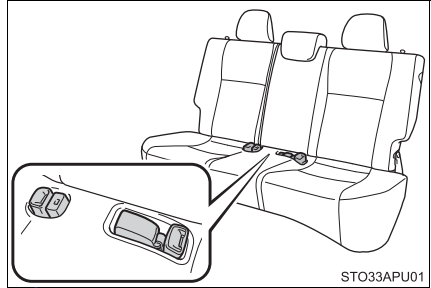

- 2 Stow the seat belts.  
Center: →P. 28  
Outer: Use the seat belt hangers to prevent the belts from being tangled.

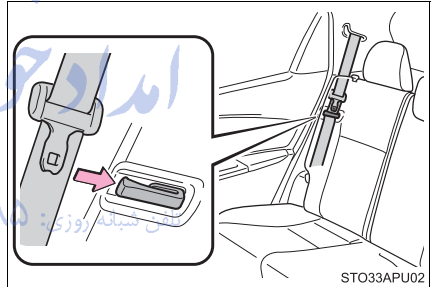

- 3 Remove the outer head restraints. (→P. 104)
- 4 Lower the center head restraints to the lowest position.

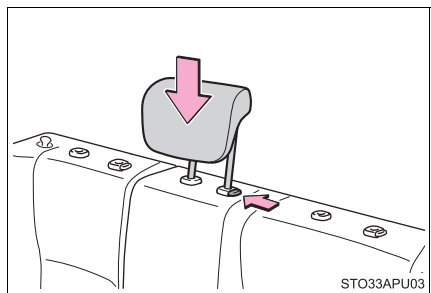

- 5 Pull the seatback lock release knob and fold the seatback down.

Each seatback may be folded separately.

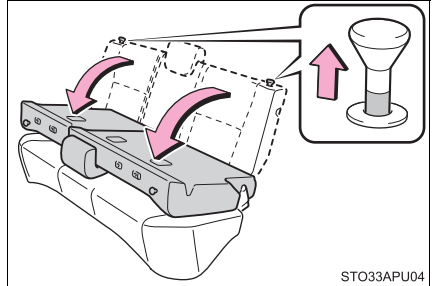

STO33APU04

## ⚠ WARNING

### ■ When folding the rear seatbacks down

Observe the following precautions. Failure to do so may result in death or serious injury.

- Do not fold the seatbacks down while driving.
- Stop the vehicle on level ground, set the parking brake and shift the shift lever to P (automatic transmission) or N (manual transmission).
- Do not allow anyone to sit on a folded seatback or in the luggage compartment while driving.
- Do not allow children to enter the luggage compartment.
- Do not allow anyone to sit on the rear center seat if the rear right seat is folded down, as the seat belt buckle for the rear center seat belt is then concealed under the folded seat and cannot be used.
- Be careful not to catch your hand when folding the rear seatbacks.
- If it is necessary to detach the head restraints, remove it from the vehicle or store it securely in the luggage compartment. This will prevent it from injuring passengers in the event of sudden braking, sudden swerving or an accident.
- Depending on the position of the front seat, it may interfere when trying to fold down the rear seatbacks. If this happens, adjust the position of the front seat.

**⚠ WARNING**

■ **After returning the rear seatback to the upright position**

Observe the following precautions. Failure to do so may result in death or serious injury.

- Make sure that the seatback is securely locked in position by lightly pushing it back and forth.

If the seatback is not securely locked, the red marking will be visible on the seatback lock release knob. Make sure that the red marking is not visible.

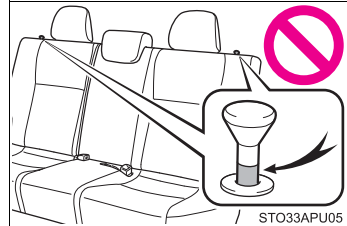

- Check that the seat belts are not twisted or caught in the seatback.

**⚠ NOTICE**

■ **Stowing the seat belts**

The seat belts and the buckles must be stowed before you fold down the rear seatbacks.

تلفن شبانه روزی: ۰۲۱-۸۸۶۲۰۸۵

FarmaSOS.com

## Head restraints

Head restraints are provided for all seats.

### Adjusting the front seats and rear center seat head restraints

① Up

Pull the head restraints up.

② Down

Push the head restraint down while pressing the lock release button.

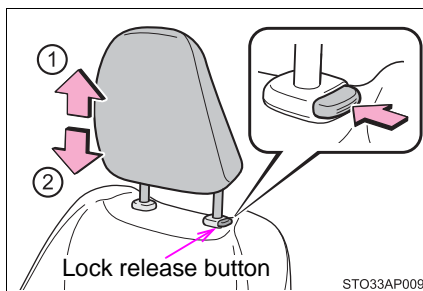

### Removing the front seats and rear center seat head restraints

Pull the head restraint up while pressing the lock release button.

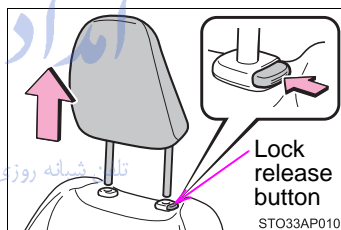

### Removing the rear outer seats head restraints

- 1 Pull the lock release knob and fold down the seatback until it reaches the position where the head restraints can be removed.

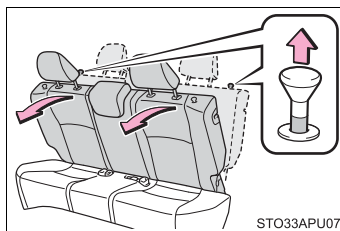

- 2 Pull the head restraint up while pushing the lock release button.

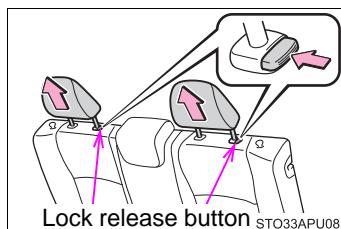



### ■ Installing the front seats and rear center seat head restraints

Align the head restraint with installation holes and push it down to the lock position.

Press and hold the lock release button when lowering the head restraint.

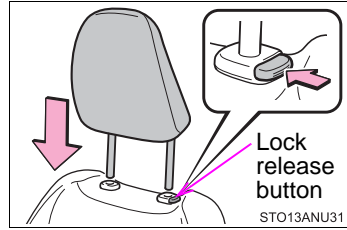

### ■ Installing the rear outer seats head restraints

- 1 Pull the lock release knob and fold down the seatback until it reaches the position where the head restraints can be installed.

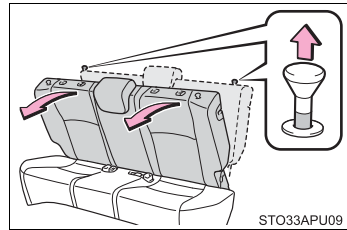

- 2 Align the head restraint with installation holes and push it down to the lock position.

Press and hold the lock release button when lowering the head restraint.

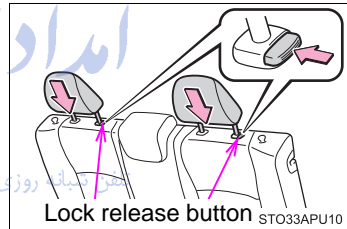

### ■ Adjusting the height of the head restraints

Make sure that the head restraints are adjusted so that the center of the head restraint is closest to the top of your ears.

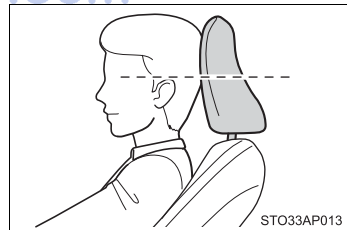

### ■ Adjusting the rear center seat head restraint

Always raise the head restraint one level from the stowed position when in use.

### ■ Rear outer seats head restraints

The head restraints do not have adjustment function.

**⚠ WARNING****■ Head restraint precautions**

Observe the following precautions regarding the head restraints. Failure to do so may result in death or serious injury.

- Use the head restraints designed for each respective seat.
- Adjust the head restraints to the correct position at all times.
- After adjusting the head restraints, push down on them and make sure they are locked in position.
- Do not drive with the head restraints removed.

امداد خودرو فارما

تلفن شبانه روزی: ۰۲۱-۸۸۶۲۰۸۵

FarmaSOS.com

## Steering wheel

### Adjustment procedure

- 1 Hold the steering wheel and push the lever down.

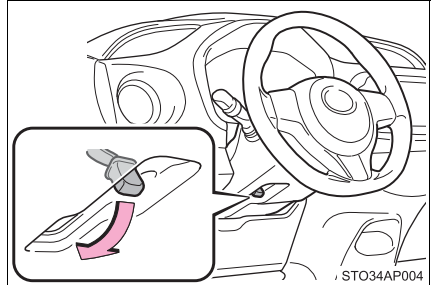

- 2 Adjust to the ideal position by moving the steering wheel.  
After adjustment, pull the lever up to secure the steering wheel.

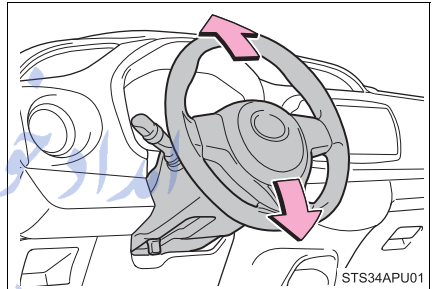

### Horn

To sound the horn, press on or close to the  mark.

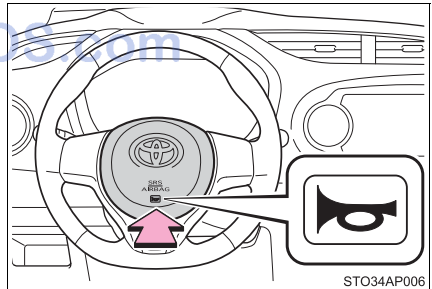

 **WARNING****■ Caution while driving**

Do not adjust the steering wheel while driving.

Doing so may cause the driver to mishandle the vehicle and cause an accident, resulting in death or serious injury.

**■ After adjusting the steering wheel**

Make sure that the steering wheel is securely locked.

Otherwise, the steering wheel may move suddenly, possibly causing an accident and resulting in death or serious injury.

امداد خودرو فارما

تلفن شبانه روزی: ۰۲۱-۸۸۸۶۲۰۸۵

FarmaSOS.com

## Inside rear view mirror

The rear view mirror's position can be adjusted to enable sufficient confirmation of the rear view.

### Adjusting the height of rear view mirror

The height of the rear view mirror can be adjusted to suit your driving posture.

Adjust the height of the rear view mirror by moving it up and down.

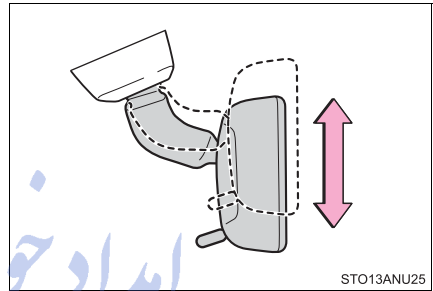

### Anti-glare function

Reflected light from the headlights of vehicles behind can be reduced by operating the lever.

- ① Normal position
- ② Anti-glare position

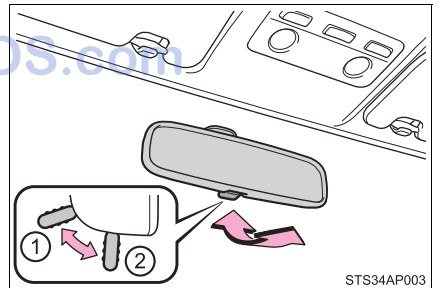

**WARNING****Caution while driving**

Do not adjust the position of the mirror while driving.

Doing so may lead to mishandling of the vehicle and cause an accident, resulting in death or serious injury.

امداد خودرو فارما

تلفن شبانه روزی: ۰۲۱-۸۸۸۶۲۰۸۵

[FarmaSOS.com](http://FarmaSOS.com)

## Outside rear view mirrors

### Adjustment procedure

#### ► Manually-adjustable type

Adjust the mirror up, down, in or out by pushing the mirror surface.

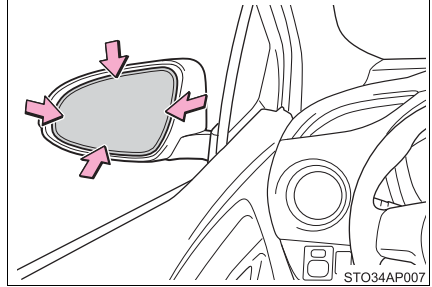

#### ► Power-adjustable type

1 To select a mirror to adjust, press the switch.

- ① Left
- ② Right

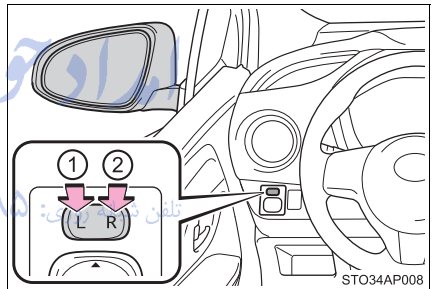

2 To adjust the mirror, press the switch.

- ① Up
- ② Right
- ③ Down
- ④ Left

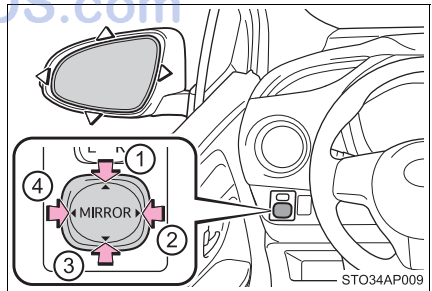

### Folding the mirrors

Push the mirror back in the direction of the vehicle's rear.

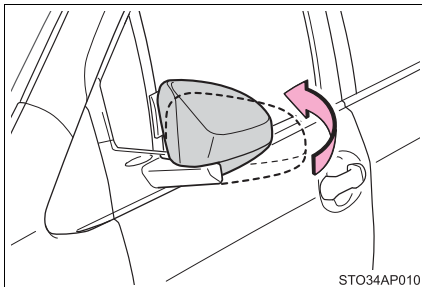

#### ■ Mirror angle can be adjusted when (power-adjustable type)

The engine switch is in the "ACC" or "ON" position.

#### ■ When the mirrors are fogged up (vehicles with outside rear view mirror defoggers)

The outside rear view mirrors can be cleared using the mirror defoggers. Turn on the rear window defogger to turn on the outside rear view mirror defoggers. (→P. 176)



#### WARNING

#### ■ Important points while driving

Observe the following precautions while driving.

Failure to do so may result in loss of control of the vehicle and cause an accident, resulting in death or serious injury.

- Do not adjust the mirrors while driving.
- Do not drive with the mirrors folded.
- Both the driver and passenger side mirrors must be extended and properly adjusted before driving.

#### ■ When a mirror is moving (power-adjustable type)

To avoid personal injury and mirror malfunction, be careful not to get your hand caught by the moving mirror.

#### ■ When the mirror defoggers are operating (vehicles with outside rear view mirror defoggers)

Do not touch the rear view mirror surfaces, as they can become very hot and burn you.



## Power windows

### Opening and closing procedures

The power windows can be opened and closed using the switches. Operating the switch moves the windows as follows:

- ① Closing
- ② Opening
- ③ One-touch opening (driver's window only)\*

\*: To stop the window partway, operate the switch in the opposite direction.

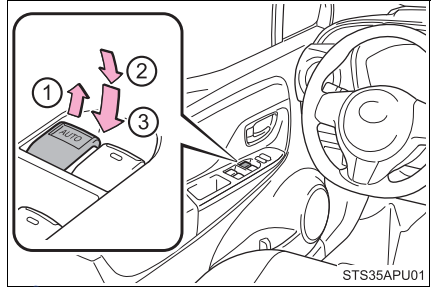

### Window lock switch

Press the switch down to lock the passenger window switches.

Use this switch to prevent children from accidentally opening or closing a passenger window.

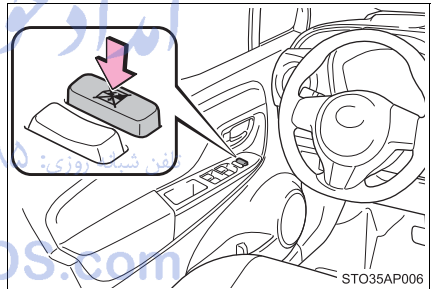

**■ The power windows can be operated when**

The engine switch is in the “ON” position.

**■ Operating the power windows after turning the engine**

The power windows can be operated for approximately 45 seconds even after the engine switch is turned to the “ACC” or “LOCK” position. They cannot, however, be operated once either front door is opened.

**WARNING**

Observe the following precautions.

Failure to do so may result in death or serious injury.

**■ Closing the windows**

- The driver is responsible for all the power window operations, including the operation for the passengers. In order to prevent accidental operation, especially by a child, do not let a child operate the power windows. It is possible for children and other passengers to have body parts caught in the power window. Also, when riding with a child, it is recommended to use the window lock switch. (→P. 113)
- Check to make sure that all passengers do not have any part of their body in a position where it could be caught when a window is being operated.
- When exiting the vehicle, turn the engine switch off, carry the key and exit the vehicle along with the child. There may be accidental operation, due to mischief, etc., that may possibly lead to an accident.

## Driving

# 4

- 4-1. Before driving**
- Driving the vehicle..... 116
  - Cargo and luggage ..... 127
  - Vehicle load limits ..... 131
  - Trailer towing..... 132
  - Dinghy towing (vehicles with an automatic transmission)..... 133
  - Dinghy towing (vehicles with a manual transmission)..... 134
- 4-2. Driving procedures**
- Engine (ignition) switch ..... 136
  - Automatic transmission ..... 139
  - Manual transmission ..... 141
  - Turn signal lever..... 142
  - Parking brake ..... 143
- 4-3. Operating the lights and wipers**
- Headlight switch..... 144
  - Fog light switch ..... 147
  - Windshield wipers and washer ..... 149
  - Rear window wiper and washer ..... 152
- 4-4. Refueling**
- Opening the fuel tank cap ..... 155
- 4-5. Using the driving support systems**
- Cruise control ..... 158
  - Driving assist systems ..... 162
- 4-6. Driving tips**
- Winter driving tips ..... 167

## Driving the vehicle

**The following procedures should be observed to ensure safe driving:**

### Starting the engine

→P. 136

### Driving

▶ Vehicles with an automatic transmission

- 1 With the brake pedal depressed, shift the shift lever to D. (→P. 139)
- 2 Release the parking brake. (→P. 143)
- 3 Gradually release the brake pedal and gently depress the accelerator pedal to accelerate the vehicle.

▶ Vehicles with a manual transmission

- 1 While depressing the clutch pedal, shift the shift lever to 1. (→P. 141)
- 2 Release the parking brake. (→P. 143)
- 3 Gradually release the clutch pedal. At the same time, gently depress the accelerator pedal to accelerate the vehicle.

FarmaSOS.com

## Stopping

### ▶ Vehicles with an automatic transmission

- 1 With the shift lever in D, depress the brake pedal.
- 2 If necessary, set the parking brake.

If the vehicle is to be stopped for an extended period of time, shift the shift lever to P or N. (→P. 139)

### ▶ Vehicles with a manual transmission

- 1 While depressing the clutch pedal, depress the brake pedal.
- 2 If necessary, set the parking brake.

If the vehicle is to be stopped for an extended period of time, shift the shift lever to N. (→P. 141)

## Parking the vehicle

### ▶ Vehicles with an automatic transmission

- 1 With the shift lever in D, depress the brake pedal.
- 2 Set the parking brake. (→P. 143)
- 3 Shift the shift lever to P. (→P. 139, 141)

If parking on a hill, block the wheels as needed.

- 4 Turn the engine switch to the “LOCK” position to stop the engine.
- 5 Lock the door, making sure that you have the key on your person.

FarmaSOS.com

▶ Vehicles with a manual transmission

- 1 While depressing the clutch pedal, depress the brake pedal.
- 2 Set the parking brake. (→P. 143)
- 3 Shift the shift lever to N. (→P. 141)

If parking on a hill, shift the shift lever to 1 or R and block the wheels as needed.

- 4 Turn the engine switch to the “LOCK” position to stop the engine.
- 5 Lock the door, making sure that you have the key on your person.

### Starting off on a steep uphill

▶ Vehicles with an automatic transmission

- 1 Firmly set the parking brake with the brake pedal depressed, and then shift the shift lever to D.
- 2 Release the brake pedal and gently depress the accelerator pedal.
- 3 Release the parking brake.

▶ Vehicles with a manual transmission

- 1 With the parking brake firmly set and the clutch pedal fully depressed, shift the shift lever to 1.
- 2 Lightly depress the accelerator pedal at the same time as gradually releasing the clutch pedal.
- 3 Release the parking brake.

### ■ Driving in the rain

- Drive carefully when it is raining, because visibility will be reduced, the windows may become fogged-up, and the road will be slippery.
- Drive carefully when it starts to rain, because the road surface will be especially slippery.
- Refrain from high speeds when driving on an expressway in the rain, because there may be a layer of water between the tires and the road surface, preventing the steering and brakes from operating properly.

### ■ Engine speed while driving

In the following conditions, the engine speed may become high while driving. This is due to automatic up-shifting control or down-shifting implementation to meet driving conditions. It does not indicate sudden acceleration.

- The vehicle is judged to be driving uphill or downhill
- When the accelerator pedal is released

### ■ Breaking in your new Toyota

To extend the life of the vehicle, observing the following precautions is recommended:

- For the first 200 miles (300 km):  
Avoid sudden stops.
- For the first 500 miles (800 km) (3-door models for Canada):  
Do not tow a trailer.
- For the first 1000 miles (1600 km):
  - Do not drive at extremely high speeds.
  - Avoid sudden acceleration.
  - Do not drive continuously in low gears.
  - Do not drive at a constant speed for extended periods.

### ■ Eco-friendly driving (vehicles with an automatic transmission)

During Eco-friendly acceleration operation (Eco driving), Eco Driving Indicator Light will turn on. When the accelerator pedal is depressed excessively, and when the vehicle is stopped, the light turns off.

Eco Driving Indicator Light will not operate in the following conditions:

- The shift lever is in anything other than D.
- The vehicle speed is approximately 80 mph (130 km/h) or higher.

Eco Driving Indicator Light can be activated or deactivated. (→P. 80)

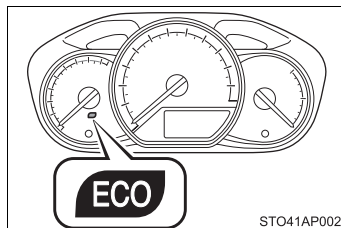

### ■ Operating your vehicle in a foreign country

Comply with the relevant vehicle registration laws and confirm the availability of the correct fuel. (→P. 317)

#### ▲ WARNING

Observe the following precautions. Failure to do so may result in death or serious injury.

#### ■ When starting the vehicle (automatic transmission)

Always keep your foot on the brake pedal while stopped with the engine running. This prevents the vehicle from creeping.

#### ■ When driving the vehicle

- Do not drive if you are unfamiliar with the location of the brake and accelerator pedals to avoid depressing the wrong pedal.
  - Accidentally depressing the accelerator pedal instead of the brake pedal will result in sudden acceleration that may lead to an accident.
  - When backing up, you may twist your body around, leading to difficulty in operating the pedals. Make sure to operate the pedals properly.
  - Make sure to keep a correct driving posture even when moving the vehicle only slightly. This allows you to depress the brake and accelerator pedals properly.
  - Depress the brake pedal using your right foot. Depressing the brake pedal using your left foot may delay response in an emergency, resulting in an accident.



 **WARNING**

Observe the following precautions.

Failure to do so may result in death or serious injury.

- Do not drive the vehicle over or stop the vehicle near flammable materials. The exhaust system and exhaust gases can be extremely hot. These hot parts may cause a fire if there is any flammable material nearby.
- During normal driving, do not turn off the engine. Turning the engine off while driving will not cause loss of steering or braking control, but the power assist to these systems will be lost. This will make it more difficult to steer and brake, so you should pull over and stop the vehicle as soon as it is safe to do so.  
However, in the event of an emergency, such as if it becomes impossible to stop the vehicle in the normal way: →P. 263
- Use engine braking (downshift) to maintain a safe speed when driving down a steep hill.  
Using the brakes continuously may cause the brakes to overheat and lose effectiveness. (→P. 139, 141)
- Do not adjust the positions of the steering wheel, the seat, or the inside or outside rear view mirrors while driving.  
Doing so may result in a loss of vehicle control.
- Always check that all passengers' arms, heads or other parts of their body are not outside the vehicle.
- Do not drive in excess of the speed limit. Even if the legal speed limit permits it, do not drive over 85 mph (140 km/h) unless your vehicle has high-speed capability tires. Driving over 85 mph (140 km/h) may result in tire failure, loss of control and possible injury. Be sure to consult a tire dealer to determine whether the tires on your vehicle are high-speed capability tires or not before driving at such speeds.

 **WARNING**

Observe the following precautions.

Failure to do so may result in death or serious injury.

■ **When driving on slippery road surfaces**

- Sudden braking, acceleration and steering may cause tire slippage and reduce your ability to control the vehicle.
- Sudden acceleration, engine braking due to shifting, or changes in engine speed could cause the vehicle to skid, resulting in an accident.
- After driving through a puddle, depress the brake pedal to make sure that the brakes are functioning properly. Wet brake pads may prevent the brakes from functioning properly. If the brakes on only one side are wet and not functioning properly, steering control may be affected.

■ **When shifting the shift lever**

- On vehicles with an automatic transmission, do not let the vehicle roll backward while the shift lever is in a driving position, or roll forward while the shift lever is in R.  
Doing so may cause the engine to stall or lead to poor brake and steering performance, resulting in an accident or damage to the vehicle.
- On vehicles with an automatic transmission, do not shift the shift lever to P while the vehicle is moving.  
Doing so can damage the transmission and may result in a loss of vehicle control.
- Do not shift the shift lever to R while the vehicle is moving forward.  
Doing so can damage the transmission and may result in a loss of vehicle control.
- Do not shift the shift lever to D (automatic transmission) or 1 (manual transmission) while the vehicle is moving backward.  
Doing so can damage the transmission and may result in a loss of vehicle control.
- Shifting the shift lever to N while the vehicle is moving will disengage the engine from the transmission. Engine braking is not available when N is selected.
- On vehicles with an automatic transmission, be careful not to shift the shift lever with the accelerator pedal depressed. Shifting the shift lever to a gear other than P or N may lead to unexpected rapid acceleration of the vehicle that may cause an accident and result in death or serious injury.

**WARNING**
**■ If you hear a squealing or scraping noise (brake pad wear limit indicators)**

Have the brake pads checked and replaced by your Toyota dealer as soon as possible.

Rotor damage may result if the pads are not replaced when needed.

It is dangerous to drive the vehicle when the wear limits of the brake pads and/or those of the brake discs are exceeded.

**■ When the vehicle is stopped**

- Do not race the engine.

If the vehicle is in any gear other than P (automatic transmission) or N, the vehicle may accelerate suddenly and unexpectedly, causing an accident.

- On vehicles with an automatic transmission, in order to prevent accidents due to the vehicle rolling away, always keep depressing the brake pedal while the engine is running, and apply the parking brake as necessary.

- If the vehicle is stopped on an incline, in order to prevent accidents caused by the vehicle rolling forward or backward, always depress the brake pedal and securely apply the parking brake as needed.

- Avoid revving or racing the engine.

Running the engine at high speed while the vehicle is stopped may cause the exhaust system to overheat, which could result in a fire if combustible material is nearby.

**■ When the vehicle is parked**

- Do not leave glasses, cigarette lighters, spray cans, or soft drink cans in the vehicle when it is in the sun.

Doing so may result in the following:

- Gas may leak from a cigarette lighter or spray can, and may lead to a fire.
- The temperature inside the vehicle may cause the plastic lenses and plastic material of glasses to deform or crack.
- Soft drink cans may rupture, causing the contents to spray over the interior of the vehicle, and may also cause a short circuit in the vehicle's electrical components.
- Do not leave cigarette lighters in the vehicle. If a cigarette lighter is in a place such as the glove box or on the floor, it may be lit accidentally when luggage is loaded or the seat is adjusted, causing a fire.

**⚠ WARNING**

- Do not attach adhesive discs to the windshield or windows. Do not place containers such as air fresheners on the instrument panel or dashboard. Adhesive discs or containers may act as lenses, causing a fire in the vehicle.
- Do not leave a door or window open if the curved glass is coated with a metallized film such as a silver-colored one. Reflected sunlight may cause the glass to act as a lens, causing a fire.
- Always apply the parking brake, shift the shift lever to P (automatic transmission), stop the engine and lock the vehicle.  
Do not leave the vehicle unattended while the engine is running.
- Do not touch the exhaust pipes while the engine is running or immediately after turning the engine off.  
Doing so may cause burns.

**■ When taking a nap in the vehicle**

Always turn the engine off. Otherwise, if you accidentally move the shift lever or depress the accelerator pedal, this could cause an accident or fire due to engine overheating. Additionally, if the vehicle is parked in a poorly ventilated area, exhaust gases may collect and enter the vehicle, leading to death or a serious health hazard.

**■ When braking**

- When the brakes are wet, drive more cautiously.  
Braking distance increases when the brakes are wet, and this may cause one side of the vehicle to brake differently than the other side. Also, the parking brake may not securely hold the vehicle.
- If the power brake assist function does not operate, do not follow other vehicles closely and avoid hills or sharp turns that require braking.  
In this case, braking is still possible, but the brake pedal should be depressed more firmly than usual. Also, the braking distance will increase. Have your brakes fixed immediately.
- Do not pump the brake pedal if the engine stalls.  
Each push on the brake pedal uses up the reserve for the power-assisted brakes.
- The brake system consists of 2 individual hydraulic systems; if one of the systems fails, the other will still operate. In this case, the brake pedal should be depressed more firmly than usual and the braking distance will increase. Have your brakes fixed immediately.



## NOTICE

### ■ When driving the vehicle

#### ▶ Vehicles with an automatic transmission

- Do not depress the accelerator and brake pedals at the same time during driving, as this may restrain the engine output.
- Do not use the accelerator pedal or depress the accelerator and brake pedals at the same time to hold the vehicle on a hill.

#### ▶ Vehicles with a manual transmission

- Do not depress the accelerator and brake pedals at the same time during driving, as this may restrain the engine output.
- Do not shift gears unless the clutch pedal is fully depressed. After shifting, do not release the clutch pedal abruptly. Doing so may damage the clutch, transmission and gears.
- Observe the following to prevent the clutch from being damaged.
  - Do not rest your foot on the clutch pedal while driving. Doing so may cause clutch trouble.
  - Do not use any gear other than the 1st gear when starting off and moving forward. Doing so may damage the clutch.
  - Do not use the clutch to hold the vehicle when stopping on an uphill grade. Doing so may damage the clutch.
- Do not shift the shift lever to R when the vehicle is still moving. Doing so may damage the clutch, transmission and gears.

### ■ When parking the vehicle (automatic transmission)

Always shift the shift lever to P. Failure to do so may cause the vehicle to move or the vehicle may accelerate suddenly if the accelerator pedal is accidentally depressed.

### ■ Avoiding damage to vehicle parts

- Do not turn the steering wheel fully in either direction and hold it there for an extended period of time. Doing so may damage the power steering motor.
- When driving over bumps in the road, drive as slowly as possible to avoid damaging the wheels, underside of the vehicle, etc.

**NOTICE****■ If you get a flat tire while driving**

A flat or damaged tire may cause the following situations. Hold the steering wheel firmly and gradually depress the brake pedal to slow down the vehicle.

- It may be difficult to control your vehicle.
- The vehicle will make abnormal sounds or vibrations.
- The vehicle will lean abnormally.

Information on what to do in case of a flat tire (→P. 281)

**■ When encountering flooded roads**

Do not drive on a road that has flooded after heavy rain, etc. Doing so may cause the following serious damage to the vehicle:

- Engine stalling
- Short in electrical components
- Engine damage caused by water immersion

In the event that you drive on a flooded road and the vehicle is flooded, be sure to have your Toyota dealer check the following:

- Brake function
- Changes in quantity and quality of engine oil and transmission fluid, etc.
- Lubricant condition for the bearings and suspension joints (where possible), and the function of all joints, bearings, etc.

## Cargo and luggage

### Take notice of the following information about storage precautions, cargo capacity and load:

- Stow cargo and luggage in the luggage compartment whenever possible.
- Be sure all items are secured in place.
- To maintain vehicle balance while driving, position luggage evenly within the luggage compartment.
- For better fuel economy, do not carry unnecessary weight.

### Capacity and distribution

Cargo capacity depends on the total weight of the occupants.

(Cargo capacity) = (Total load capacity) – (Total weight of occupants)

#### Steps for Determining Correct Load Limit—

- (1) Locate the statement “The combined weight of occupants and cargo should never exceed XXX kg or XXX lbs.” on your vehicle’s placard.
- (2) Determine the combined weight of the driver and passengers that will be riding in your vehicle.
- (3) Subtract the combined weight of the driver and passengers from XXX kg or XXX lbs.
- (4) The resulting figure equals the available amount of cargo and luggage load capacity.

For example, if the “XXX” amount equals 1400 lbs. and there will be five 150 lb passengers in your vehicle, the amount of available cargo and luggage load capacity is 650 lbs. (1400 – 750 (5 × 150) = 650 lbs.)

- (5) Determine the combined weight of luggage and cargo being loaded on the vehicle. That weight may not safely exceed the available cargo and luggage load capacity calculated in Step 4.

- (6) If your vehicle will be towing a trailer, load from your trailer will be transferred to your vehicle. Consult this manual to determine how this reduces the available cargo and luggage load capacity of your vehicle.

Toyota does not recommend towing a trailer with your vehicle. Your vehicle is not designed for trailer towing.

### Calculation formula for your vehicle

- ① Cargo capacity
- ② Total load capacity (vehicle capacity weight) (→P. 306)

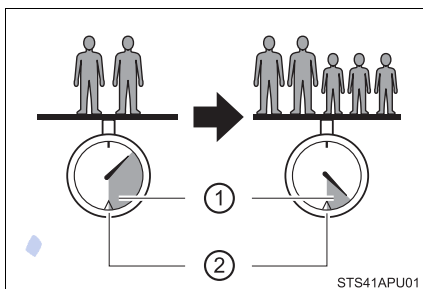

When 2 people with the combined weight of A lb. (kg) are riding in your vehicle, which has a total load capacity (vehicle capacity weight) of B lb. (kg), the available amount of cargo and luggage load capacity will be C lb. (kg) as follows:

$$B^{*2} \text{ lb. (kg)} - A^{*1} \text{ lb. (kg)} = C^{*3} \text{ lb. (kg)}$$

\*1: A = Weight of people

\*2: B = Total load capacity

\*3: C = Available cargo and luggage load

In this condition, if 3 more passengers with the combined weight of D lb. (kg) get on, the available cargo and luggage load will be reduced E lb. (kg) as follows:

$$C \text{ lb. (kg)} - D^{*4} \text{ lb. (kg)} = E^{*5} \text{ lb. (kg)}$$

\*4: D = Additional weight of people

\*5: E = Available cargo and luggage load



As shown in the example above, if the number of occupants increases, the cargo and luggage load will be reduced by an amount that equals the increased weight due to the additional occupants. In other words, if an increase in the number of occupants causes an excess of the total load capacity (combined weight of occupants plus cargo and luggage load), you must reduce the cargo and luggage on your vehicle.



## WARNING

### ■ Things that must not be carried in the luggage compartment

The following things may cause a fire if loaded in the luggage compartment:

- Receptacles containing gasoline
- Aerosol cans

### ■ Storage precautions

Observe the following precautions.

Failure to do so may prevent the pedals from being depressed properly, may block the driver's vision, or may result in items hitting the driver or passengers, possibly causing an accident.

- Stow cargo and luggage in the luggage compartment whenever possible.
- Do not stack anything in the luggage compartment higher than the seatbacks.
- Do not place cargo or luggage in or on the following locations:
  - At the feet of the driver
  - On the front passenger or rear seats (when stacking items)
  - On the luggage cover
  - On the instrument panel
  - On the dashboard
- Secure all items in the occupant compartment.
- When you fold down the rear seats, long items should not be placed directly behind the front seats.
- Never allow anyone to ride in the luggage compartment. It is not designed for passengers. They should ride in their seats with their seat belts properly fastened. Otherwise, they are much more likely to suffer death or serious bodily injury, in the event of sudden braking, sudden swerving or an accident.

 **WARNING****Capacity and distribution**

- Do not exceed the maximum axle weight rating or the total vehicle weight rating.
- Even if the total load of occupant's weight and the cargo load is less than the total load capacity, do not apply the load unevenly. Improper loading may cause deterioration of steering or braking control which may cause death or serious injury.

امداد خودرو فارما

تلفن شبانه روزی: ۰۲۱-۸۸۸۶۲۰۸۵

FarmaSOS.com

## Vehicle load limits

**Vehicle load limits include total load capacity, seating capacity, towing capacity and cargo capacity.**

### ◆ **Total load capacity (vehicle capacity weight): (→P. 306)**

Total load capacity means the combined weight of occupants, cargo and luggage.

### ◆ **Seating capacity: 5 occupants (Front 2, Rear 3)**

Seating capacity means the maximum number of occupants whose estimated average weight is 150 lb. (68 kg) per person.

### ◆ **Towing capacity**

Toyota does not recommend towing a trailer with your vehicle.

### ◆ **Cargo capacity**

Cargo capacity may increase or decrease depending on the weight and the number of occupants.

### ■ **Total load capacity and seating capacity**

These details are also described on the tire and loading information label. (→P. 231)



#### **WARNING**

#### ■ **Overloading the vehicle**

Do not overload the vehicle.

It may not only cause damage to the tires, but also degrade steering and braking ability, resulting in an accident.

## Trailer towing

**Toyota does not recommend towing a trailer with your vehicle. Toyota also does not recommend the installation of a tow hitch or the use of a tow hitch carrier for a wheelchair, scooter, bicycle, etc. Your vehicle is not designed for trailer towing or for the use of tow hitch mounted carriers.**



امداد خودرو فارما

تلفن شبانه روزی: ۰۲۱-۸۸۶۲۰۸۵

[FarmaSOS.com](http://FarmaSOS.com)

## Dinghy towing (vehicles with an automatic transmission)

Your vehicle is not designed to be dinghy towed (with 4 wheels on the ground) behind a motor home.

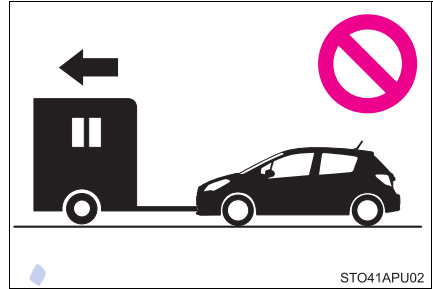

 NOTICE

- **To avoid serious damage to your vehicle**  
Do not tow your vehicle with the four wheels on the ground.

تلفن شبانه روزی: ۰۲۱-۸۸۶۲۰۸۵

FarmaSOS.com

## Dinghy towing (vehicles with a manual transmission)

Your vehicle can be dinghy towed in a forward direction (with 4 wheels on the ground) behind a motor home.

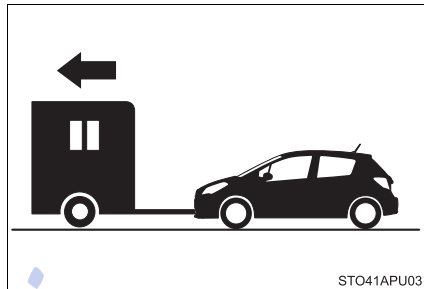

### Towing your vehicle with 4 wheels on the ground

To prevent damage to your vehicle, perform the following procedures before towing:

- 1 Shift the shift lever to N.
- 2 Turn the engine switch to the "ACC" position. تلفن

Ensure that the audio system and other powered devices are turned off.

- 3 Release the parking brake.

After towing, leave the engine in idle for at least 3 minutes before driving the vehicle.

### ■ Necessary equipment and accessories

Specialized equipment and accessories are required for dinghy towing. Contact the service branch of the motor home manufacturer regarding recommended equipment.



## NOTICE

**■ Dinghy towing direction**

Do not tow the vehicle backward.  
Doing so may cause serious damage.

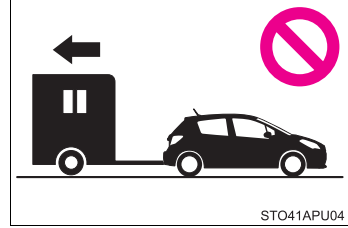
**■ To prevent the steering from locking**

Ensure the engine switch is in the "ACC" position.

امداد خودرو فارما

تلفن شبانه روزی: ۰۲۱-۸۸۶۲۰۸۵

FarmaSOS.com

## Engine (ignition) switch

### Starting the engine

- 1 Check that the parking brake is set.
- 2 Check that the shift lever is set in P (automatic transmission) or N (manual transmission).
- 3 Firmly depress the brake pedal (automatic transmission) or brake pedal and clutch pedal (manual transmission).
- 4 Turn the engine switch to the “START” position to start the engine.

### Changing engine switch positions

#### 1 “LOCK”

The steering wheel is locked and the key can be removed. (Vehicles with an automatic transmission: The key can be removed only when the shift lever is in P.)

#### 2 “ACC”

Some electrical components such as the audio system can be used.

#### 3 “ON”

All electrical components can be used.

#### 4 “START”

For starting the engine.

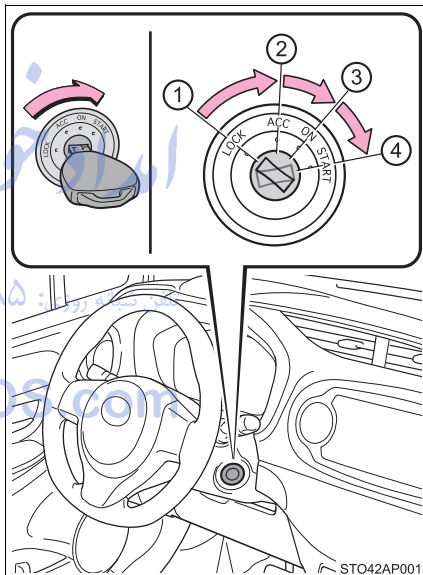

STO42AP001



### ■ Turning the key from “ACC” to “LOCK”

- 1 Shift the shift lever to P (automatic transmission) or N (manual transmission). (→P. 139, 141)
- 2 Push in the key and turn it to the “LOCK” position.

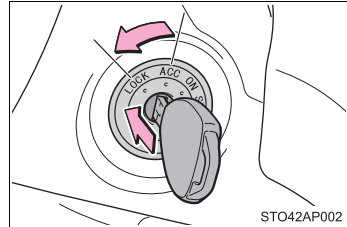

### ■ If the engine does not start (vehicles with an engine immobilizer system)

The engine immobilizer system may not have been deactivated. (→P. 67)  
Contact your Toyota dealer.

### ■ When the steering lock cannot be released

When starting the engine, the engine switch may seem stuck in the “LOCK” position. To free it, turn the key while turning the steering wheel slightly left and right.

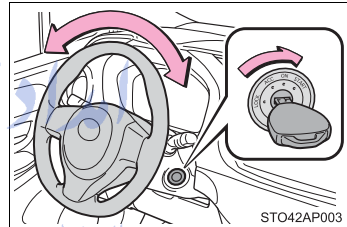

### ■ Key reminder function

A buzzer sounds if the driver's door is opened while the engine switch is in the “LOCK” or “ACC” position to remind you to remove the key.

 **WARNING****■ When starting the engine**

Always start the engine while sitting in the driver's seat. Do not depress the accelerator pedal while starting the engine under any circumstances. Doing so may cause an accident resulting in death or serious injury.

**■ Caution when driving**

Do not turn the engine switch to the "LOCK" position while driving. If, in an emergency, you must turn the engine off while the vehicle is moving, turn the engine switch only to the "ACC" position to stop the engine. An accident may result if the engine is stopped while driving. (→P. 263)

 **NOTICE****■ To prevent battery discharge**

Do not leave the engine switch in the "ACC" or "ON" position for long periods of time without the engine running.

**■ When starting the engine**

- Do not crank the engine for more than 30 seconds at a time. This may overheat the starter and wiring system.
- Do not race a cold engine.
- If the engine becomes difficult to start or stalls frequently, have your vehicle checked by your Toyota dealer immediately.

## Automatic transmission\*

### Shifting the shift lever

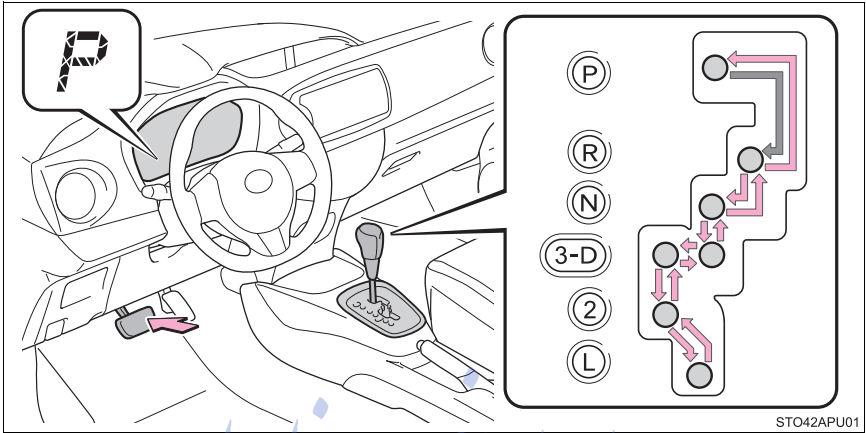

← While the engine switch is in the “ON” position, move the shift lever with the brake pedal depressed.

When shifting the shift lever between P and D, make sure that the vehicle is completely stopped.

### Shift position purpose

Shift position	Function
P	Parking the vehicle or starting the engine
R	Reversing
N	Neutral
D	Normal driving*
3	Position for engine braking
2	Position for more powerful engine braking
L	Position for maximum engine braking

\*: Shifting to the D position allows the system to select a gear suitable for the driving conditions. Setting the shift lever to the D position is recommended for normal driving.

\*: If equipped

### ■ Downshift restriction

The maximum allowable speeds are as follows.

Downshifting	Maximum speed mph (km/h)
D→3	84 (135)
3→2	53 (85)
2→L	25 (40)

### ■ AI-SHIFT

AI-SHIFT automatically selects the suitable gear according to driver performance and driving conditions.

AI-SHIFT automatically operates when the shift lever is in the D position.

### ■ When driving with cruise control activated (if equipped)

Even when performing the following actions with the intent of enabling engine braking, engine braking will not activate while downshifting to 3 because cruise control will not be canceled. (→P. 158)

### ■ If the shift lever cannot be shifted from P

→P. 296

### ⚠ WARNING

#### ■ When driving on slippery road surfaces

Do not accelerate or shift gears suddenly. تلفن شبانه روزی: ۰۲۱-۸۸۸۸۸۸۸۸

Sudden changes in engine braking may cause the vehicle to spin or skid, resulting in an accident.

FarmaSOS.com

## Manual transmission\*

### Shifting the shift lever

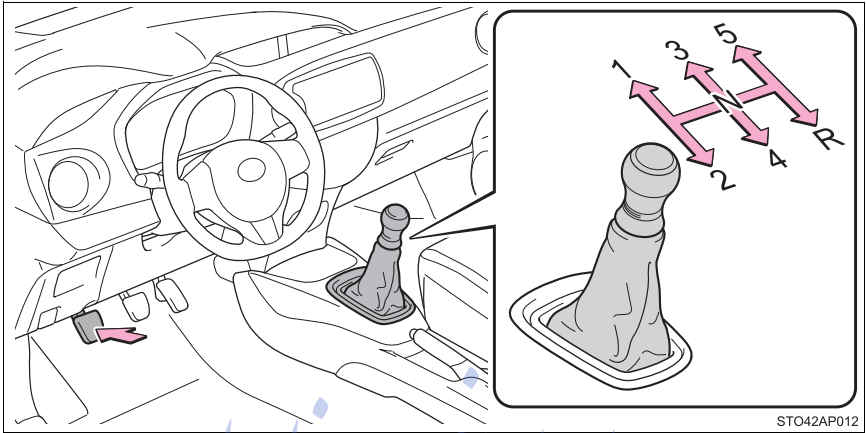

STO42AP012

Fully depress the clutch pedal before operating the shift lever, and then release it slowly.

If it is difficult to shift in reverse, shift the shift lever to N, release the clutch pedal momentarily, and then try again.

#### ■ Maximum downshifting speed

Observe the downshifting speeds in the following table to prevent over-revving the engine.

mph (km/h)

Shift position	Maximum speed
1	30 (49)
2	57 (92)
3	83 (134)
4	113 (181)

\*: If equipped

## Turn signal lever

### Operation instructions

- ① Right turn
- ② Lane change to the right (push and hold the lever partway)  
The right hand signals will flash until you release the lever.
- ③ Lane change to the left (push and hold the lever partway)  
The left hand signals will flash until you release the lever.
- ④ Left turn

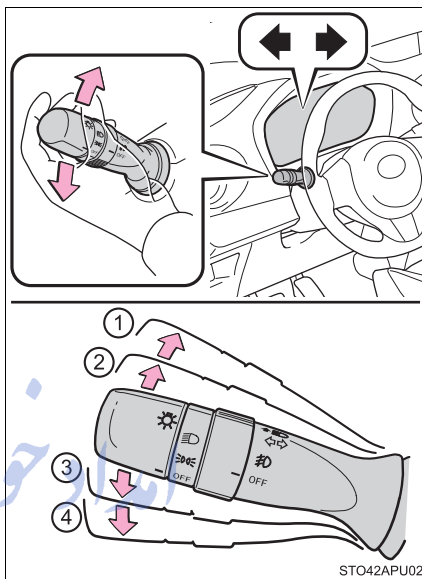

#### ■ Turn signals can be operated when

The engine switch is in the "ON" position.

#### ■ If the indicator flashes faster than usual

Check that a light bulb in the front or rear turn signal lights has not burned out.

## Parking brake

### Operation instructions

- ① To set the parking brake, fully pull the parking brake lever while depressing the brake pedal.
- ② To release the parking brake, slightly raise the lever and lower it completely while pressing the button.

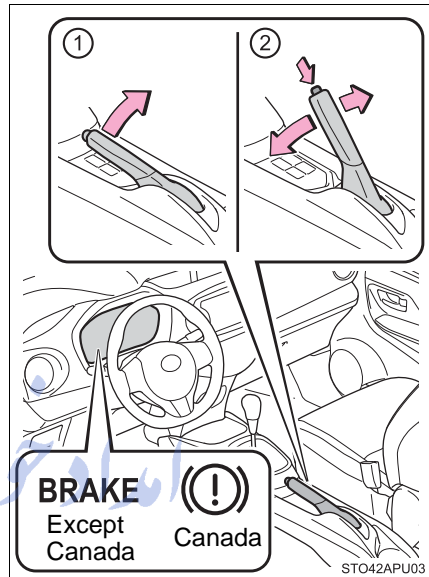

### Usage in winter time

See "Winter driving tips" for parking brake usage in winter time. (→P. 168)

### NOTICE

#### Before driving

Fully release the parking brake.

Driving the vehicle with the parking brake set will lead to brake components overheating, which may affect braking performance and increase brake wear.

## Headlight switch

The headlights can be operated manually.

### Operation instructions

Turning the end of the lever turns on the lights as follows:

► Type A

① **OFF** Off

Vehicles with daytime running light system:  
The daytime running lights turn on.

②  The side marker, parking, tail, license plate, daytime running lights (if equipped) and instrument panel lights turn on.

③  The headlights and all lights listed above (except daytime running lights) turn on.

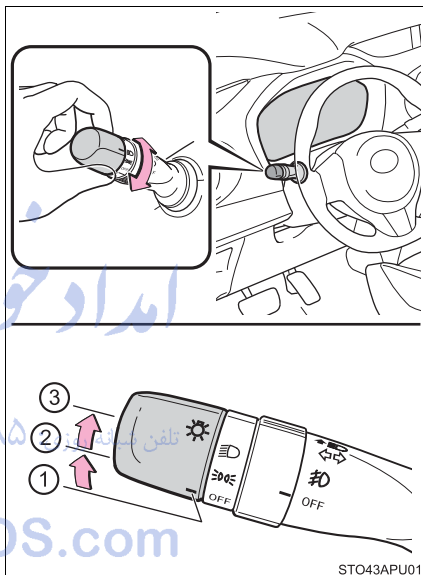

STO43APU01



## ▶ Type B

- ① ○ Off

Vehicles with daytime running light system:  
The daytime running lights turn on.

- ②  The side marker, parking, tail, license plate, daytime running lights (if equipped) and instrument panel lights turn on.

- ③  The headlights and all lights listed above (except daytime running lights) turn on.

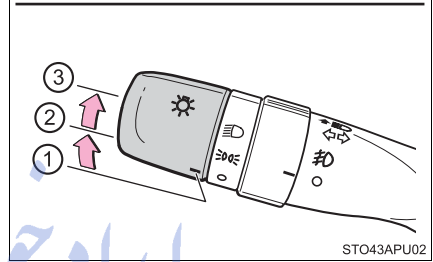
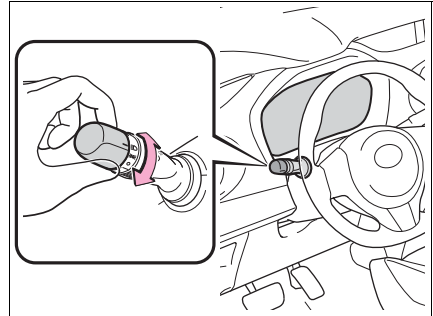

## ▶ Type C

- ① DRL The daytime running lights turn on.

- ②  The side marker, parking, tail, license plate, daytime running lights and instrument panel lights turn on.

- ③  The headlights and all lights listed above (except daytime running lights) turn on.

- ④ OFF The daytime running lights turn off.

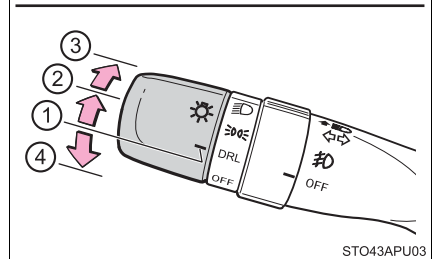
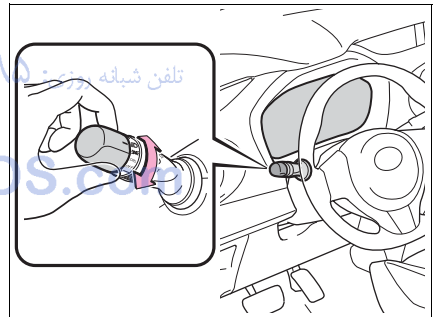

### Turning on the high beam headlights

- ① With the headlights on, push the lever away from you to turn on the high beams.

Pull the lever toward you to the center position to turn the high beams off.

- ② Pull the lever toward you and release it to flash the high beams once.

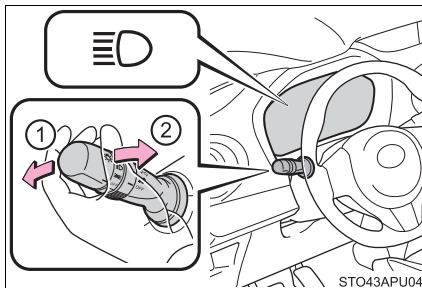

You can flash the high beams with the headlights on or off.

### Daytime running light system (if equipped)

- Vehicles with reflector type headlights: To make your vehicle more visible to other drivers, the headlights turn on automatically (at a reduced intensity) whenever the engine is started and the parking brake is released. Daytime running lights are not designed for use at night.

For type C of this headlight, daytime running lights can be turned off by operating the switch.

Vehicles with projector type headlights: To make your vehicle more visible to other drivers, the daytime running lights turn on automatically whenever the engine is started and the parking brake is released. Daytime running lights are not designed for use at night.

For type C of this headlight, daytime running lights can be turned off by operating the switch.

- Compared to turning on the headlights, the daytime running light system offers greater durability and consumes less electricity, so it can help improve fuel economy.

### Light reminder buzzer

A buzzer sounds when the engine switch is turned to the "LOCK" or "ACC" position and the driver's door is opened while the lights are turned on.

#### NOTICE

#### To prevent battery discharge

Do not leave the lights on longer than necessary when the engine is not running.

## Fog light switch\*

The fog lights secure excellent visibility in difficult driving conditions, such as in rain and fog.

### Operation instructions

► Type A

- ① OFF Turns the front fog lights off
- ②  Turns the front fog lights on

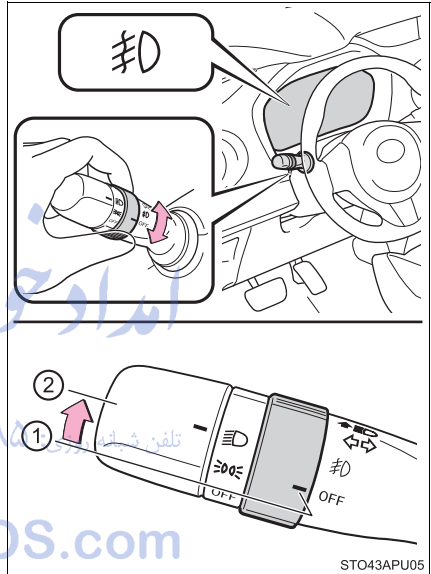

STO43APU05

## ► Type B

- ① ○ Turns the front fog lights off
- ② ☹️ Turns the front fog lights on

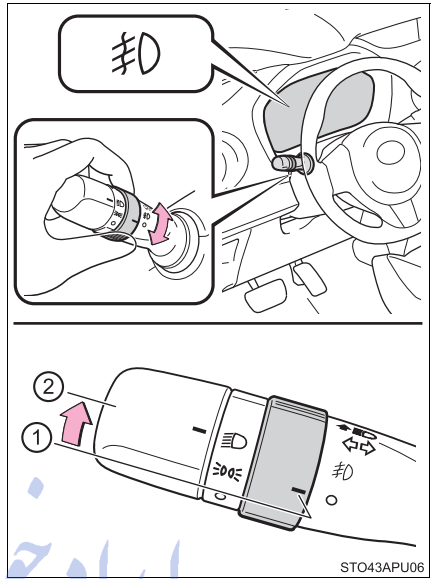

## ■ Fog lights can be used when

The headlights are on in low beam.

تلفن شبانه روزی: ۰۲۱-۸۸۶۲۰۸۵

FarmaSOS.com

## Windshield wipers and washer

### Operating the wiper lever

Operate the lever as follows to operate the wipers.

► Type A



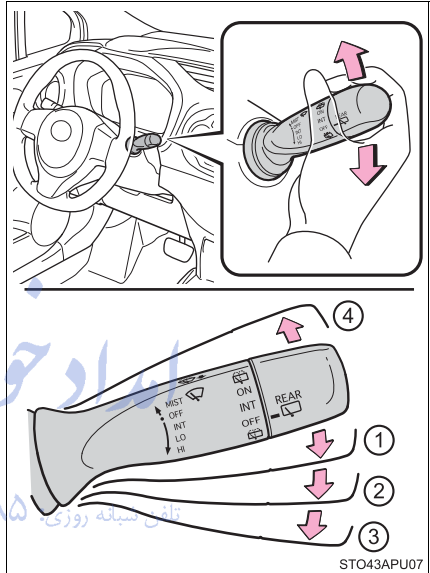

- ① **INT** Intermittent windshield wiper operation
- ② **LO** Low speed windshield wiper operation
- ③ **HI** High speed windshield wiper operation
- ④ **MIST** Temporary operation

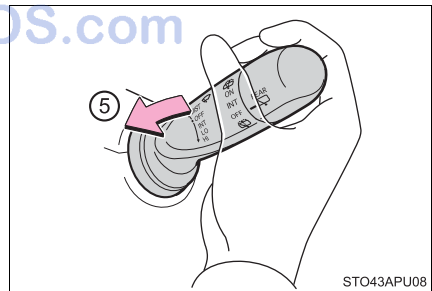

- ⑤ **Washer/wiper dual operation**  
The wipers will automatically operate a couple of times after the washer squirts.



## ► Type B

- ①  Intermittent windshield wiper operation
- ②  Low speed windshield wiper operation
- ③  High speed windshield wiper operation
- ④  Temporary operation

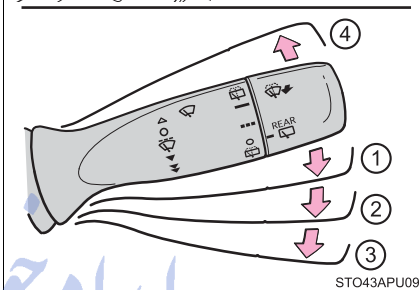
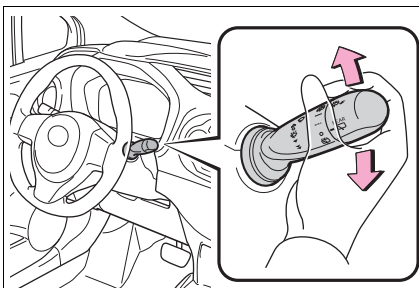

STO43APU09

- ⑤ Washer/wiper dual operation

The wiper will automatically operate a couple of times after the washer squirts.

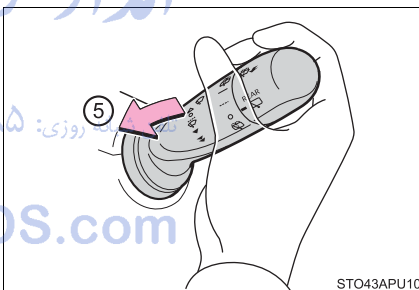

STO43APU10

■ **The windshield wiper and washer can be operated when**

The engine switch is in the "ON" position.

■ **If no windshield washer fluid sprays**

Check that the washer nozzles are not blocked, if there is washer fluid in the windshield washer fluid reservoir.

**NOTICE****■ When the windshield is dry**

Do not use the wiper, as they may damage the windshield.

**■ When the washer fluid tank is empty**

Do not operate the switch continually as the washer fluid pump may over-heat.

**■ When a nozzle becomes blocked**

In this case, contact your Toyota dealer.

Do not try to clear it with a pin or other object. The nozzle will be damaged.

امداد خودرو فارما

تلفن شبانه روزی: ۰۲۱-۸۸۸۶۲۰۸۵



FarmaSOS.com

## Rear window wiper and washer

### Operation instructions

Turning the end of the lever turns on the rear window wiper and washer.

► Vehicles without intermittent rear wiper (Type A)

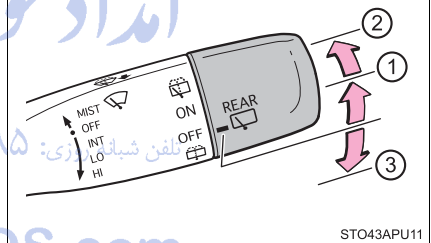
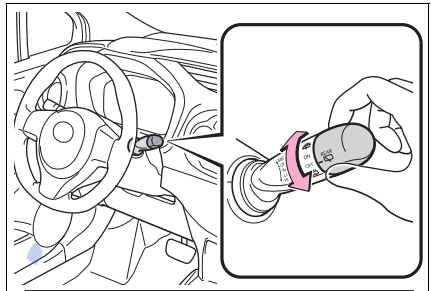

- ① **ON** Normal window wiper operation
- ②  Washer/wiper dual operation
- ③  Washer operation



STO43APU11



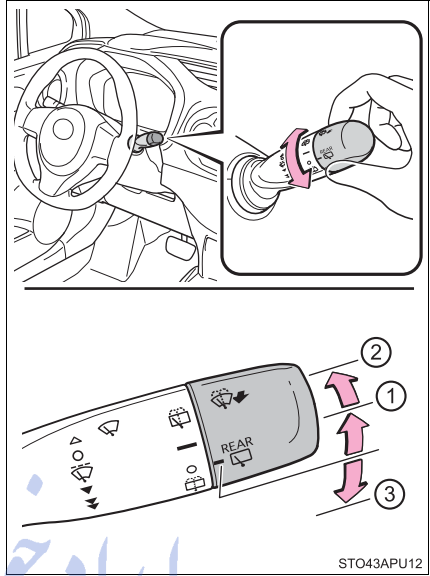

► Vehicles without intermittent rear wiper (Type B)

- ①  Normal window wiper operation
- ②  Washer/wiper dual operation
- ③  Washer operation





► Vehicles with intermittent rear wiper (Type A)

- ① **INT** Intermittent window wiper operation
- ② **ON** Normal window wiper operation
- ③  Washer/wiper dual operation
- ④  Washer/wiper dual operation

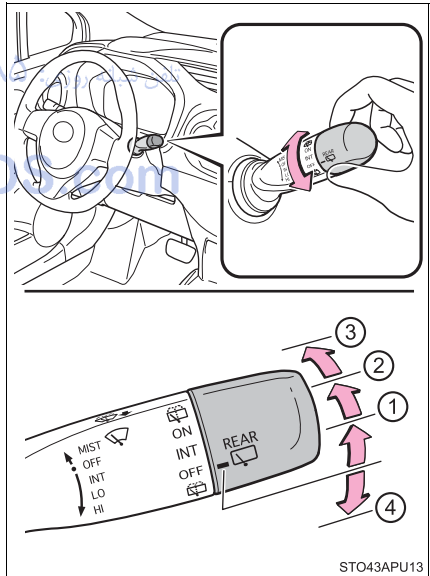
The wiper will automatically operate a couple of time after the wiper squirts.



► Vehicles with intermittent rear wiper (Type B)

- ① ■■■ Intermittent window wiper operation
- ② — Normal window wiper operation
- ③  Washer/wiper dual operation
- ④  Washer/wiper dual operation

The wiper will automatically operate a couple of time after the wiper squirts.

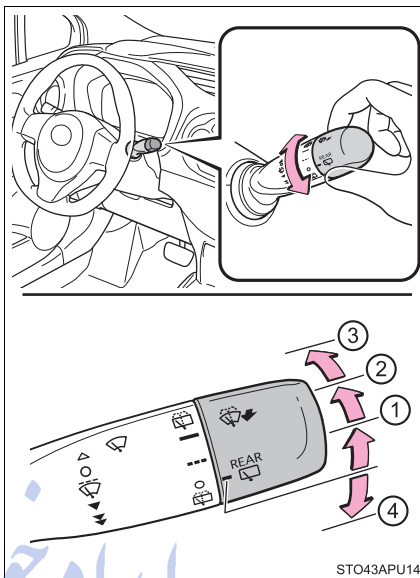

■ **The rear window wiper and washer can be operated when**

The engine switch is in the "ON" position.

■ **If no washer fluid sprays**

Check that the washer nozzle is not blocked, if there is washer fluid in the washer fluid reservoir.



NOTICE

FarmaSOS.com

■ **When the rear window is dry**

Do not use the wiper, as it may damage the rear window.

■ **When the washer fluid tank is empty**

Do not operate the switch continually as the washer fluid pump may over-heat.

■ **When a nozzle becomes blocked**

In this case, contact your Toyota dealer.

Do not try to clear it with a pin or other object. The nozzle will be damaged.

## Opening the fuel tank cap

**Perform the following steps to open the fuel tank cap:**

### Before refueling the vehicle

- Close all the doors and windows, and turn the engine switch to the “LOCK” position.
- Confirm the type of fuel.

### ■ Fuel types

Unleaded gasoline (Octane rating 87 [Research Octane Number of 91] or higher)

### WARNING

#### ■ When refueling the vehicle

Observe the following precautions while refueling the vehicle. Failure to do so may result in death or serious injury.

- After exiting the vehicle and before opening the fuel door, touch an unpainted metal surface to discharge any static electricity. It is important to discharge static electricity before refueling because sparks resulting from static electricity can cause fuel vapors to ignite while refueling.
- Always hold the grips on the fuel tank cap and turn it slowly to remove it. A whooshing sound may be heard when the fuel tank cap is loosened. Wait until the sound cannot be heard before fully removing the cap. In hot weather, pressurized fuel may spray out the filler neck and cause injury.
- Do not allow anyone that has not discharged static electricity from their body to come close to an open fuel tank.
- Do not inhale vaporized fuel.  
Fuel contains substances that are harmful if inhaled.
- Do not smoke while refueling the vehicle.  
Doing so may cause the fuel to ignite and cause a fire.
- Do not return to the vehicle or touch any person or object that is statically charged.  
This may cause static electricity to build up, resulting in a possible ignition hazard.

 **WARNING****■ When refueling**

Observe the following precautions to prevent fuel overflowing from the fuel tank:

- Securely insert the fuel nozzle into the fuel filler neck.
- Stop filling the tank after the fuel nozzle automatically clicks off.
- Do not top off the fuel tank.

 **NOTICE****■ Refueling**

Do not spill fuel during refueling.

Doing so may damage the vehicle, such as causing the emission control system to operate abnormally, damage fuel system components, or damage the vehicle's painted surface.

امداد خودرو فارما

تلفن شبانه روزی: ۰۲۱-۸۸۶۲۰۸۵

FarmaSOS.com

### Opening the fuel tank cap

- 1 Pull up the opener to open the fuel filler door.

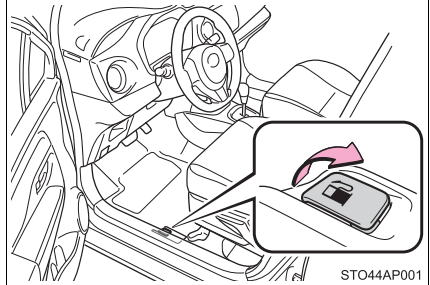

- 2 Turn the fuel tank cap slowly to open.

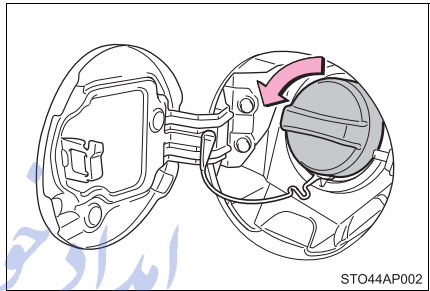

### Closing the fuel tank cap

After refueling, turn the fuel tank cap until you hear a click. Once the cap is released, it will turn slightly in the opposite direction.

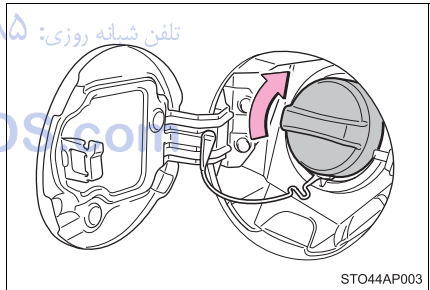

### WARNING

#### ■ When replacing the fuel tank cap

Do not use anything but a genuine Toyota fuel tank cap designed for your vehicle. Doing so may cause a fire or other incident which may result in death or serious injury.

# Cruise control\*

## Summary of functions

Use the cruise control to maintain a set speed without depressing the accelerator pedal.

- ① Indicators
- ② Cruise control switch

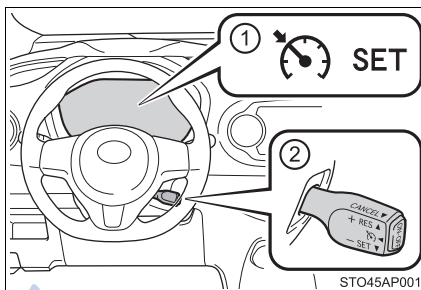

## Setting the vehicle speed

- 1 Press the “ON-OFF” button to activate the cruise control.

Cruise control indicator will come on.

Press the button again to deactivate the cruise control.

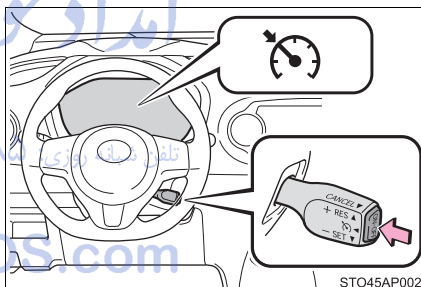

- 2 Accelerate or decelerate the vehicle to the desired speed, and push the lever down to set the speed.

“SET” indicator will come on.

The vehicle speed at the moment the lever is released becomes the set speed.

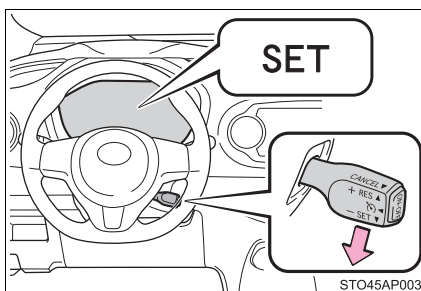

## Adjusting the set speed

To change the set speed, operate the lever until the desired set speed is obtained.

- ① Increases the speed
- ② Decreases the speed

**Fine adjustment:** Momentarily move the lever in the desired direction.

**Large adjustment:** Hold the lever in the desired direction.

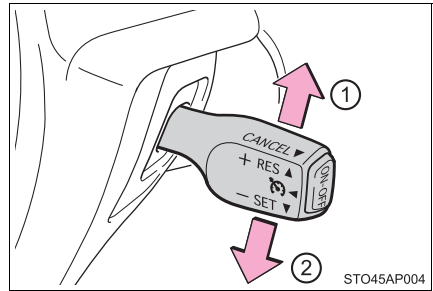

The set speed will be increased or decreased as follows:

**Fine adjustment:** By approximately 1 mph (1.6 km/h) each time the lever is operated.

**Large adjustment:** The set speed can be increased or decreased continually until the lever is released.

## Canceling and resuming the constant speed control

- ① Pulling the lever toward you cancels the constant speed control.

The speed setting is also canceled when the brakes are applied or the clutch pedal (manual transmission only) is depressed.

- ② Pushing the lever up resumes the constant speed control.

Resuming is available when the vehicle speed is more than approximately 25 mph (40 km/h).

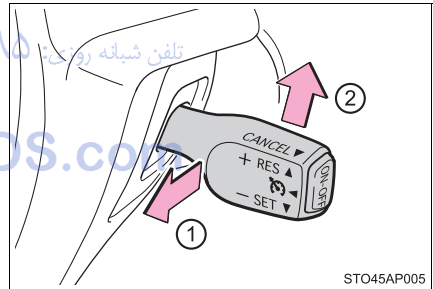

**■ Cruise control can be set when**

- The shift lever is in the D or range 3. (vehicles with an automatic transmission)
- Vehicle speed is above approximately 25 mph (40 km/h).

**■ Accelerating after setting the vehicle speed**

- The vehicle can be accelerated normally. After acceleration, the set speed resumes.
- Even without canceling the cruise control, the set speed can be increased by first accelerating the vehicle to the desired speed and then pushing the lever down to set the new speed.

**■ Automatic cruise control cancellation**

Cruise control will stop maintaining the vehicle speed in any of the following situations.

- Actual vehicle speed falls more than approximately 10 mph (16 km/h) below the preset vehicle speed.  
At this time, the memorized set speed is not retained.
- Actual vehicle speed is below approximately 25 mph (40 km/h).
- VSC is activated.

**■ If the cruise control indicator light comes on in yellow**

Press the "ON-OFF" button once to deactivate the system, and then press the button again to reactivate the system.

If the cruise control speed cannot be set or if the cruise control cancels immediately after being activated, there may be a malfunction in the cruise control system. Have the vehicle inspected by your Toyota dealer.



**WARNING****■ To avoid operating the cruise control by mistake**

Switch the cruise control off using the “ON-OFF” button when not in use.

**■ Situations unsuitable for cruise control**

Do not use cruise control in any of the following situations.

Doing so may result in loss of control and could cause an accident resulting in death or serious injury.

- In heavy traffic
- On roads with sharp bends
- On winding roads
- On slippery roads, such as those covered with rain, ice or snow
- On steep hills  
Vehicle speed may exceed the set speed when driving down a steep hill.
- During emergency towing

امداد خودرو فارما

تلفن شبانه روزی: ۰۲۱-۸۸۶۲۰۸۵

FarmaSOS.com

## Driving assist systems

To help enhance driving safety and performance, the following systems operate automatically in response to various driving situations. Be aware, however, that these systems are supplementary and should not be relied upon too heavily when operating the vehicle.

### ◆ ABS (Anti-lock Brake System)

---

Helps to prevent wheel lock when the brakes are applied suddenly, or if the brakes are applied while driving on a slippery road surface

### ◆ Brake assist

---

Generates an increased level of braking force after the brake pedal is depressed when the system detects a panic stop situation

### ◆ VSC (Vehicle Stability Control)

---

Helps the driver to control skidding when swerving suddenly or turning on slippery road surfaces

### ◆ TRAC (Traction Control)

---

Helps to maintain drive power and prevent the drive wheels from spinning when starting the vehicle or accelerating on slippery roads

### ◆ EPS (Electric Power Steering)

---

Employs an electric motor to reduce the amount of effort needed to turn the steering wheel

### When the TRAC/VSC systems are operating

The slip indicator light will flash while the TRAC/VSC systems are operating.

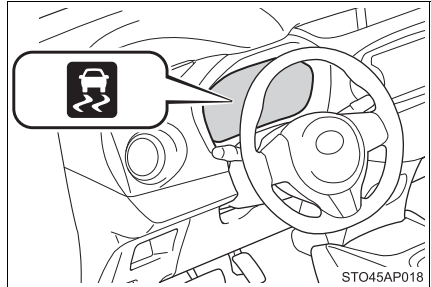

### Disabling the TRAC system

If the vehicle gets stuck in mud, dirt or snow, the TRAC system may reduce power from the engine to the wheels. Pressing VSC OFF switch to turn the system off may make it easier for you to rock the vehicle in order to free it.

To turn the TRAC system off, quickly press and release the VSC OFF switch.

The "TRAC OFF" indicator light will come on.

Press the switch again to turn the system back on.

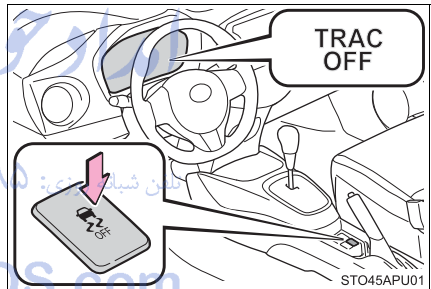

**■ Turning off both TRAC and VSC systems**

To turn the TRAC and VSC systems off, press and hold the VSC OFF switch for more than 3 seconds while the vehicle is stopped.

The “TRAC OFF” indicator light and VSC OFF indicator light will come on.

Press the switch again to turn the systems back on.

**■ When the “TRAC OFF” indicator light comes on even if the VSC OFF switch has not been pressed**

TRAC system cannot be operated. Contact your Toyota dealer.

**■ Sounds and vibrations caused by the ABS, brake assist, TRAC and VSC systems**

● A sound may be heard from the engine compartment when the engine is started or just after the vehicle begins to move. This sound does not indicate that a malfunction has occurred in any of these systems.

● Any of the following conditions may occur when the above systems are operating. None of these indicates that a malfunction has occurred.

- Vibrations may be felt through the vehicle body and steering.
- A motor sound may be heard after the vehicle comes to a stop.
- The brake pedal may pulsate slightly after the ABS is activated.
- The brake pedal may move down slightly after the ABS is activated.

**■ EPS operation sound**

When the steering wheel is operated, a motor sound (whirring sound) may be heard. This does not indicate a malfunction.

**■ Automatic reactivation of TRAC and VSC systems**

After turning the TRAC and VSC systems off, the systems will be automatically re-enabled in the following situations:

- When the engine switch is turned to the “LOCK” position
- If only the TRAC system is turned off, the TRAC will turn on when vehicle speed increases

If both the TRAC and VSC systems are turned off, automatic re-enabling will not occur when vehicle speed increases.

**■ Reduced effectiveness of the EPS system**

The effectiveness of the EPS system is reduced to prevent the system from overheating when there is frequent steering input over an extended period of time. The steering wheel may feel heavy as a result. Should this occur, refrain from excessive steering input or stop the vehicle and turn the engine off. The EPS system should return to normal within 10 minutes.

**■ If the slip indicator comes on**

It may indicate a malfunction in the systems. Contact your Toyota dealer.

**WARNING****■ The ABS does not operate effectively when**

- The limits of tire gripping performance have been exceeded (such as excessively worn tires on a snow covered road).
- The vehicle hydroplanes while driving at high speed on wet or slick roads.

**■ Stopping distance when the ABS is operating may exceed that of normal conditions**

The ABS is not designed to shorten the vehicle's stopping distance. Always maintain a safe distance from the vehicle in front of you, especially in the following situations:

- When driving on dirt, gravel or snow-covered roads
- When driving with tire chains
- When driving over bumps in the road
- When driving over roads with potholes or uneven surfaces

**■ TRAC may not operate effectively when**

Directional control and power may not be achievable while driving on slippery road surfaces, even if the TRAC system is operating. Drive the vehicle carefully in conditions where stability and power may be lost.

 **WARNING****■ When the VSC is activated**

The slip indicator light flashes. Always drive carefully. Reckless driving may cause an accident. Exercise particular care when the indicator light flashes.

**■ When the TRAC/VSC systems are turned off**

Be especially careful and drive at a speed appropriate to the road conditions. As these are the systems to help ensure vehicle stability and driving force, do not turn the TRAC/VSC systems off unless necessary.

**■ Replacing tires**

Make sure that all tires are of the specified size, brand, tread pattern and total load capacity. In addition, make sure that the tires are inflated to the recommended tire inflation pressure level.

The ABS, TRAC and VSC systems will not function correctly if different tires are installed on the vehicle.

Contact your Toyota dealer for further information when replacing tires or wheels.

**■ Handling of tires and the suspension**

Using tires with any kind of problem or modifying the suspension will affect the driving assist systems, and may cause a system to malfunction.

تلفن شبانه روزی: ۰۲۱-۸۸۶۲۰۸۵

FarmaSOS.com

## Winter driving tips

**Carry out the necessary preparations and inspections before driving the vehicle in winter. Always drive the vehicle in a manner appropriate to the prevailing weather conditions.**

### Preparation for winter

- Use fluids that are appropriate to the prevailing outside temperatures.
  - Engine oil
  - Engine coolant
  - Washer fluid
- Have a service technician inspect the condition of the battery.
- Have the vehicle fitted with four snow tires or purchase a set of tire chains for the front tires.

Ensure that all tires are the same size and brand and that their wear level is not noticeably different with each other. Also make sure that chains match the size of the tires.

### Before driving the vehicle

Perform the following according to the driving conditions:

- Do not try to forcibly open a window or move a wiper that is frozen. Pour warm water over the frozen area to melt the ice. Wipe away the water immediately to prevent it from freezing.
- To ensure proper operation of the climate control system fan, remove any snow that has accumulated on the air inlet vents in front of the windshield.
- Check for and remove any excess ice or snow that may have accumulated on the exterior lights, vehicle's roof, chassis, around the tires or on the brakes.
- Remove any snow or mud from the bottom of your shoes before getting in the vehicle.

### When driving the vehicle

Accelerate the vehicle slowly, keep a safe distance between you and the vehicle ahead, and drive at a reduced speed suitable to road conditions.

### When parking the vehicle

Park the vehicle and move the shift lever to P (automatic transmission) or 1 or R (manual transmission) without setting the parking brake. The parking brake may freeze up, preventing it from being released. If necessary, block the wheels to prevent inadvertent sliding or creeping.

### Selecting tire chains

Use the correct tire chain size when mounting the tire chains. Chain size is regulated for each tire size.

- ① Side chain  
0.12 in. (3 mm) in diameter
- ② Cross chain  
0.16 in. (4 mm) in diameter

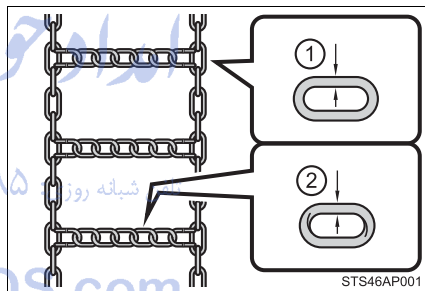

### Regulations on the use of tire chains

Regulations regarding the use of tire chains vary depending on location and type of road. Always check local regulations before installing chains.



### ■ Tire chain installation

Observe the following precautions when installing and removing chains:

- Install and remove tire chains in a safe location.
- Install tire chains on the front tires only. Do not install tire chains on the rear tires.
- Install tire chains on front tires as tightly as possible. Retighten chains after driving 1/4 — 1/2 mile (0.5 — 1.0 km).
- Install tire chains following the instructions provided with the tire chains.
- If wheel ornaments are used, they will be scratched by the chain band, so remove the ornaments before putting on the chains. (→P. 285)



### WARNING

#### ■ Driving with snow tires

Observe the following precautions to reduce the risk of accidents. Failure to do so may result in a loss of vehicle control and cause death or serious injury.

- Use tires of the specified size.
- Maintain the recommended level of air pressure.
- Do not drive in excess of 75 mph (120 km/h), regardless of the type of snow tires being used.
- Use snow tires on all, not just some wheels.
- Do not use tires of noticeably different wear level.

#### ■ Driving with tire chains

Observe the following precautions to reduce the risk of accidents. Failure to do so may result in the vehicle being unable to be driven safely, and may cause death or serious injury.

- Do not drive in excess of the speed limit specified for the tire chains being used, or 30 mph (50 km/h), whichever is lower.
- Avoid driving on bumpy road surfaces or over potholes.
- Avoid sudden acceleration, abrupt steering, sudden braking and shifting operations that cause sudden engine braking.
- Slow down sufficiently before entering a curve to ensure that vehicle control is maintained.



## NOTICE

**■ Repairing or replacing snow tires (vehicles with a tire pressure warning system)**

Request repairs or replacement of snow tires from Toyota dealers or legitimate tire retailers.

This is because the removal and attachment of snow tires affects the operation of the tire pressure warning valves and transmitters.

**■ Fitting tire chains (vehicles with a tire pressure warning system)**

The tire pressure warning valves and transmitters may not function correctly when tire chains are fitted.

امداد خودرو فارما

تلفن شبانه روزی: ۰۲۱-۸۸۶۲۰۸۵

FarmaSOS.com

## Interior features

# 5

### 5-1. Using the air conditioning system and defogger

Air conditioning system ..... 172

### 5-2. Using the audio system

Steering wheel audio switches ..... 180  
 AUX port/USB port ..... 181

### 5-3. Using the interior lights

Interior lights list ..... 182  
 • Interior light ..... 182  
 • Personal lights ..... 183

### 5-4. Using the storage features

List of storage features ..... 184  
 • Glove box ..... 185  
 • Cup holders ..... 185  
 • Bottle holders ..... 186  
 • Auxiliary box ..... 187  
 Luggage compartment features ..... 188

### 5-5. Using the other interior features

Other interior features ..... 190  
 • Sun visors ..... 190  
 • Vanity mirrors ..... 190  
 • Power outlet ..... 191  
 • Assist grips ..... 192

## Air conditioning system

### Air conditioning controls

- ▶ Vehicles without a cooling and dehumidification on/off button

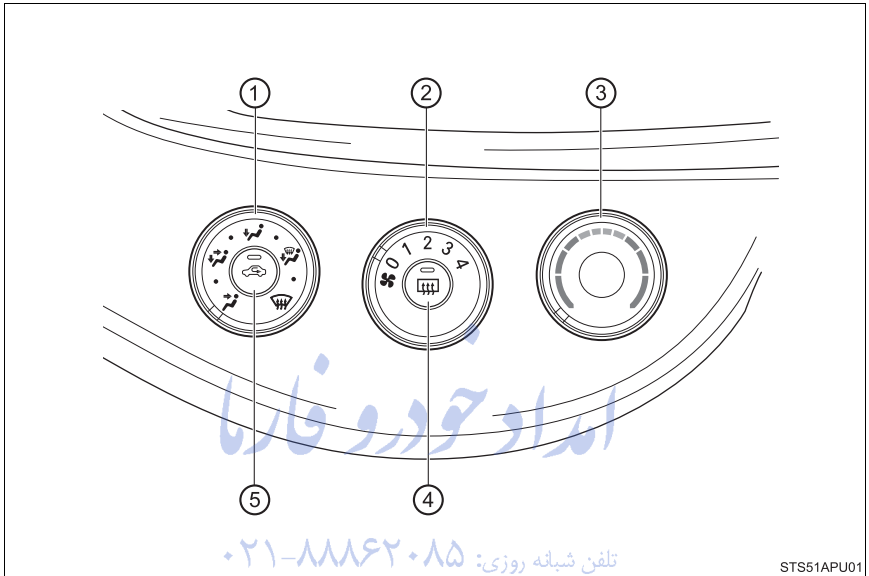

- ① Air outlet selector dial
- ② Fan speed control dial
- ③ Temperature control dial
- ④ Rear window defogger switch
- ⑤ Outside/recirculated air mode button

## ► Vehicles with a cooling and dehumidification on/off button

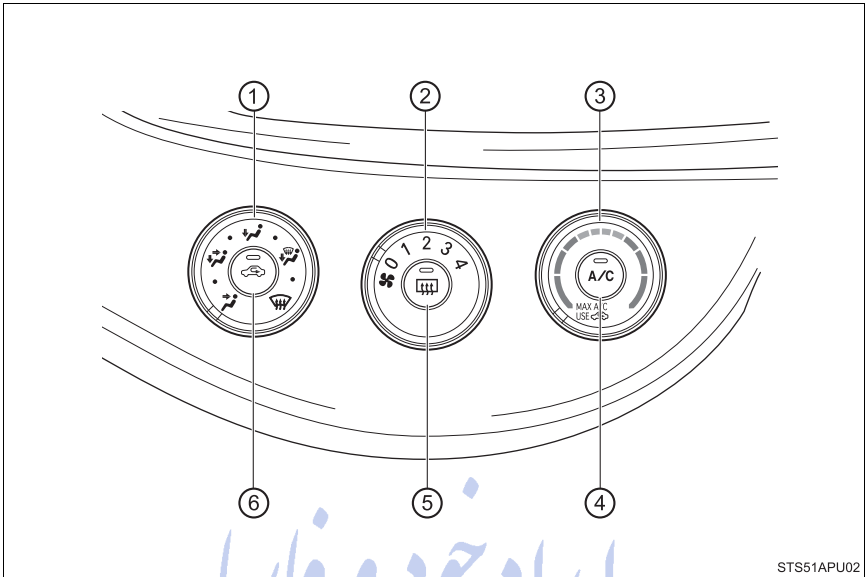

STS51APU02

- ① Air outlet selector dial
- ② Fan speed control dial
- ③ Temperature control dial
- ④ Cooling and dehumidification on/off button
- ⑤ Rear window defogger switch
- ⑥ Outside/recirculated air mode button

FarmaSOS.com

### ■ Adjusting the temperature setting

- ▶ Vehicles without the  button

Turn the temperature control dial clockwise to increase the temperature.

- ▶ Vehicles with the  button

To adjust the temperature setting, turn the temperature control dial clockwise (warm) or counterclockwise (cool).

If  is not pressed, the system will blow ambient temperature air or heated air.

For quick cooling, turn the temperature control dial to “MAX A/C” position and set the outside/recirculated air mode button to recirculated air mode.

### ■ Fan speed setting

To adjust the fan speed, turn the fan speed control dial clockwise (increase) or counterclockwise (decrease).

Turning the dial to “0” turns off the fan.

### ■ Change the airflow mode

To select the air outlets, set the air outlet selector dial to the desired position.

The positions between the air outlet selections can also be selected for more delicate adjustment.

- ① Air flows to the upper body
- ② Air flows to the upper body and feet
- ③ Air flows to the feet
- ④ Air flows to the feet and the windshield defogger operates
- ⑤ The windshield defogger operates

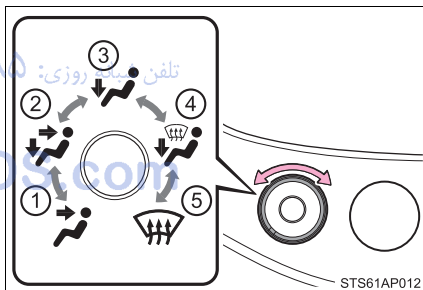

STS61AP012

### ■ Other functions

- Switching between outside air and recirculated air modes (→P. 175)
- Defogging the windshield (→P. 175)
- Defogging the rear window and outside rear view mirrors (→P. 176)

## Other functions

### ■ Switching between outside air and recirculated air modes

Press .

The mode switches between outside air mode (introduces air from outside the vehicle) (indicator off) and recirculated air mode (recycles air inside the vehicle) (indicator on) each time the button is pressed.

### ■ Defogging the windshield



Defoggers are used to defog the windshield and front side windows.

Set the air outlet selector dial to  position.

If the recirculated air mode is used, it will automatically switch to the outside air mode.

In this position, the outside/recirculated air mode cannot be changed to the recirculated air mode.

Perform the following operations accordingly:

- To adjust the fan speed, turn the fan speed control dial.
- To adjust the temperature setting, turn the temperature control dial.
- Vehicles with the  button: If the dehumidification function is not operating, press  to operate the dehumidification function.

To defog the windshield and the side windows early, turn the air flow and temperature up.

### ■ Defogging the rear window and outside rear view mirrors

- ▶ Vehicles with a rear window defogger

Defogger is used to defog the rear window.

Press .

The defogger will automatically turn off after a period of time.

- ▶ Vehicles with rear window and outside rear view mirror defoggers

Defoggers are used to defog the rear window, and to remove rain-drops, dew and frost from the outside rear view mirrors.

Press .

The defoggers will automatically turn off after a period of time.

## Air outlets

### ■ Location of air outlets

The air outlets and air volume changes according to the selected airflow mode.

← : Some models

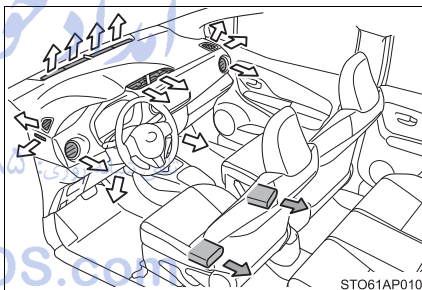



## ■ Adjusting the position, opening and closing the air outlets

### ► Front center outlets

- ① Direct air flow to the left or right, up or down.
- ② Turn the knob to open or close the vent.

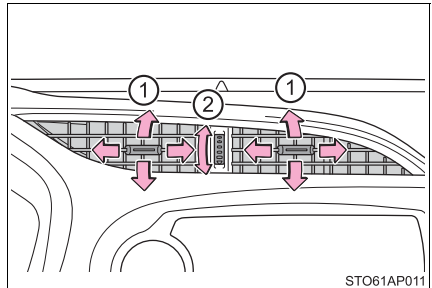

### ► Front side outlets



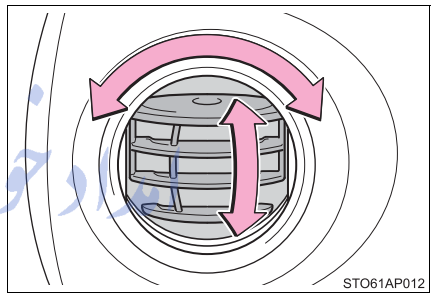

Direct air flow to the left or right, up or down.

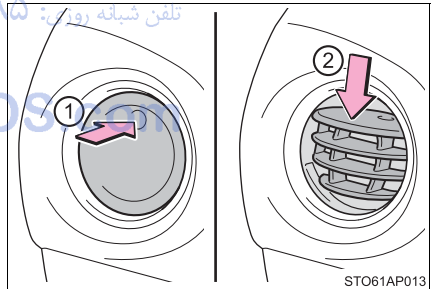

- ① Open the vent.
- ② Close the vent.



### ■ Fogging up of the windows

- Vehicles with the  button: The windows will easily fog up when the humidity in the vehicle is high. Turning  on will dehumidify the air from the outlets and defog the windshield effectively.
- Vehicles with the  button: If you turn  off, the windows may fog up more easily.
- The windows may fog up if the recirculated air mode is used.

### ■ Outside/recirculated air mode

When driving on dusty roads such as tunnels or in heavy traffic, set the outside/recirculated air mode button to the recirculated air mode. This is effective in preventing outside air from entering the vehicle interior. During cooling operation, setting the recirculated air mode will also cool the vehicle interior effectively.

### ■ When the indicator light on goes off by itself (vehicles with the button)

Press  to turn off the dehumidification function and turn it on again. There may be a problem in the air conditioning system if the indicator light goes off again. Turn the air conditioning system off and have it inspected by your Toyota dealer.

### ■ When the outside temperature falls to nearly 32°F (0°C) (vehicles with the button)

The dehumidification function may not operate even when  is pressed.

### ■ Ventilation and air conditioning odors

- To let fresh air in, set the air conditioning system to the outside air mode.
- During use, various odors from inside and outside the vehicle may enter into and accumulate in the air conditioning system. This may then cause odor to be emitted from the vents.
- To reduce potential odors from occurring:  
It is recommended that the air conditioning system be set to outside air mode prior to turning the vehicle off.

### ■ Air conditioning filter

→P. 238

 **WARNING****■ To prevent the windshield from fogging up**

Do not set the air outlet selector dial to  during cool air operation in extremely humid weather. The difference between the temperature of the outside air and that of the windshield can cause the outer surface of the windshield to fog up, blocking your vision.

**■ When the outside rear view mirror defoggers (if equipped) are on**

Do not touch the outside surface of the rear view mirrors, as they can become very hot and burn you.

 **NOTICE****■ To prevent battery discharge**

Do not leave the air conditioning system on longer than necessary when the engine is stopped.

امداد خودرو فارما

تلفن شبانه روزی: ۰۲۱-۸۸۶۲۰۸۵

FarmaSOS.com

## Steering wheel audio switches\*

Some audio features can be controlled using the switches on the steering wheel.

Operation may differ depending on the type of audio system or navigation system. For details, refer to the manual provided with the audio system or navigation system.

### Operating the audio system using the steering wheel switches

#### ① Volume switch:

- Press: Increases/decreases volume
- Press and hold: Continuously increases/decreases volume

#### ② Radio mode:

- Press: Selects a radio station
- Press and hold: Seeks up/down

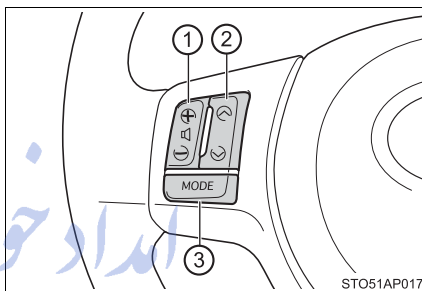

CD, MP3/WMA disc, iPod or USB mode:

- Press: Selects a track/file/song
- Press and hold: Selects a folder or album (MP3/WMA disc, iPod or USB)

#### ③ "MODE" switch

- Press: Turns the power on, selects an audio source
- Press and hold: Mutes or pauses the current operation. To cancel the mute or pause, press and hold again.



### WARNING

#### ■ To reduce the risk of an accident

Exercise care when operating the audio switches on the steering wheel.

## AUX port/USB port\*

This adapter can be used to connect a portable audio device and listen to it through the vehicle's speakers.

### Connecting using the AUX port/USB port

Open the cover and connect the portable audio device.

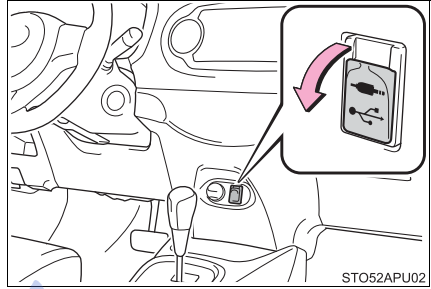

#### ■ Operating portable audio devices connected to the audio system

The volume can be adjusted using the vehicle's audio controls. All other adjustments must be made on the portable audio device itself.

#### ■ When using a portable audio device connected to the power outlet

Noise may occur during playback. Use the power source of the portable audio device.

تلفن شبانه روزی: ۰۲۱-۸۸۶۲۰۸۵



**WARNING**

#### ■ While driving

Do not connect a device or operate the device controls.

FarmaSOS.com

## Interior lights list

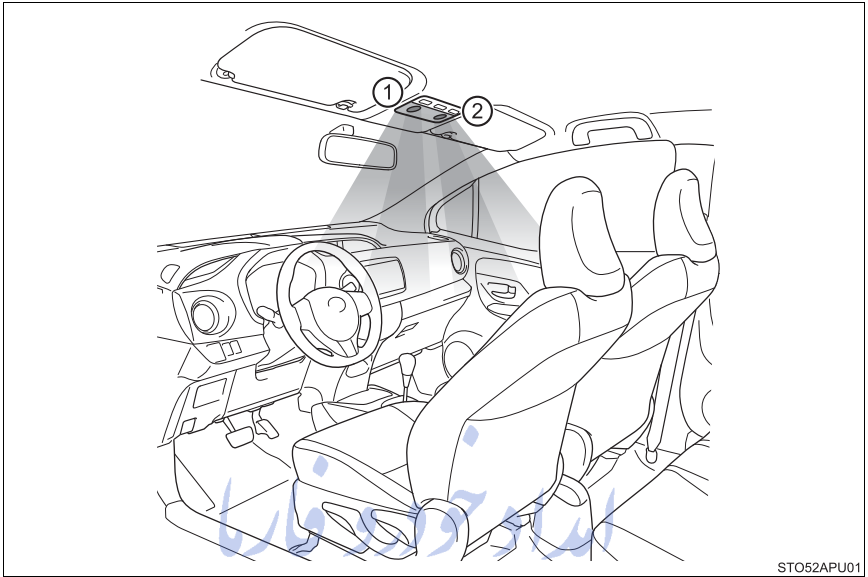

① Interior light (→P. 182)

② Personal lights (→P. 183) تلفن شبانه روزی: ۰۸۵۰۸۶۲

### Interior light

① Off

② Door position

③ On

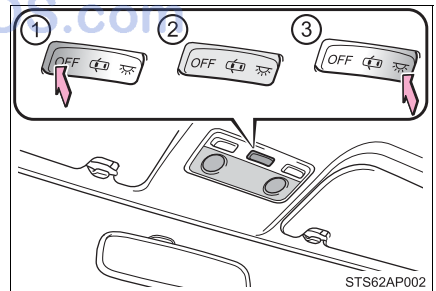

## Personal lights

- ① On
- ② Off

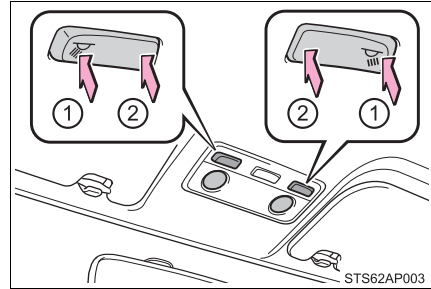

### ■ Illuminated entry system

The lights automatically turn on/off according to the engine switch position, whether the doors are locked/unlocked, and whether the doors are opened/closed.

### ■ To prevent the battery from being discharged

- The following lights will go off automatically after 20 minutes:
  - Interior/personal lights
  - Luggage compartment light
- If the engine switch light remain on when the door is not fully closed, the light will go off automatically after 20 minutes.

تلفن شبانه روزی: ۰۲۱-۸۸۶۲۰۸۵

FarmaSOS.com

## List of storage features

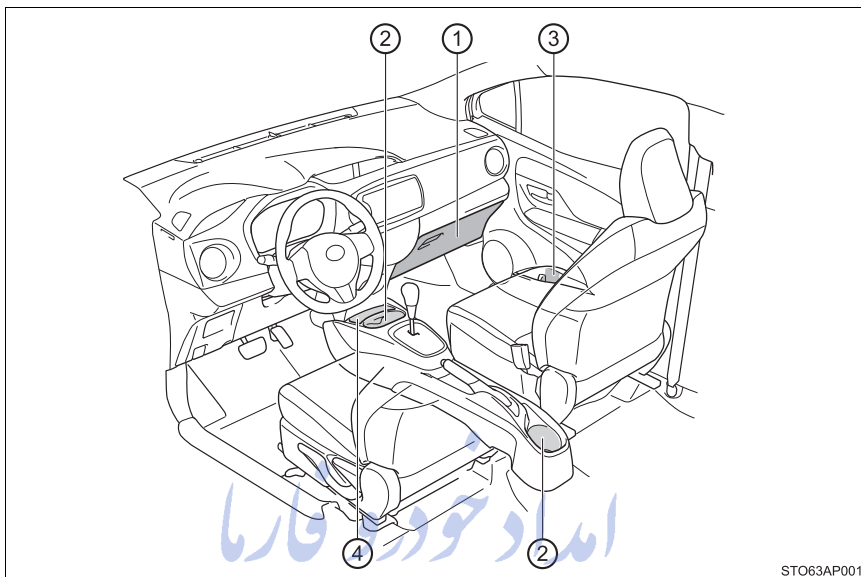

STO63AP001

- |               |           |                  |           |
|---------------|-----------|------------------|-----------|
| ① Glove box   | (→P. 185) | ③ Bottle holders | (→P. 186) |
| ② Cup holders | (→P. 185) | ④ Auxiliary box  | (→P. 187) |

### WARNING

#### ■ Items that should not be left in the storage spaces

Do not leave glasses, lighters or spray cans in the storage spaces, as this may result in the following when cabin temperature becomes high:

- Glasses may be deformed by heat or cracked if they come into contact with other stored items.
- Lighters or spray cans may explode. If they come into contact with other stored items, the lighter may catch fire or the spray can may release gas, causing a fire hazard.



## Glove box

Pull up the lever to open the glove box.

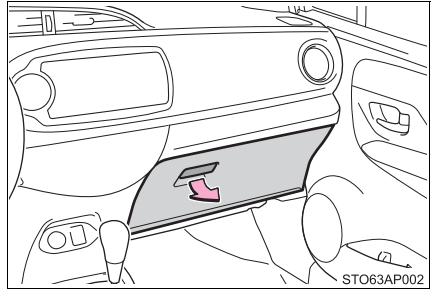

## ⚠ WARNING

### ■ Caution while driving

Keep the glove box closed. In the event of sudden braking or sudden swerving, an accident may occur due to an occupant being struck by the open glove box or the items stored inside.

## Cup holders

### ■ Front

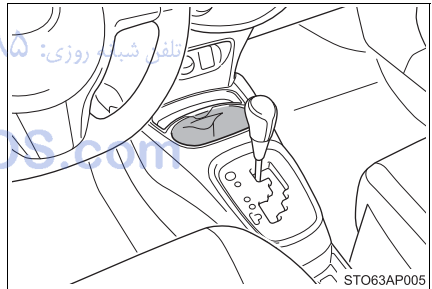

### ■ Rear

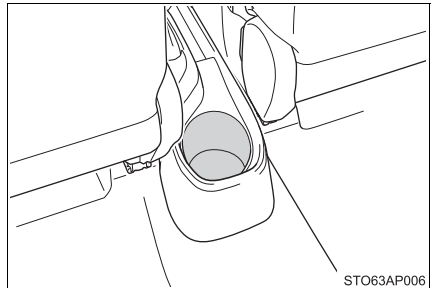

**⚠ WARNING**

**■ Items unsuitable for the cup holders**

- Do not place anything other than cups or aluminum cans in the cup holders. Other items may be thrown out of the holders in the event of an accident or sudden braking, causing injury.
- To prevent burns, cover hot drinks when placed in the cup holders.

**Bottle holders**

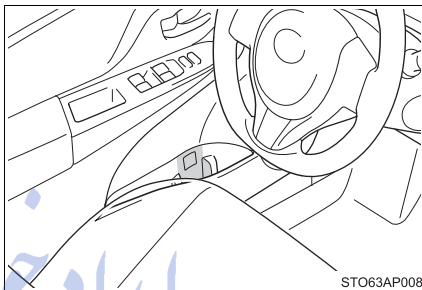

**■ When using the bottle holder**

- When storing a bottle, close the cap.
- The bottle may not be stored depending on its size or shape.

**⚠ WARNING**

**■ Items unsuitable for the bottle holders**

Do not place anything other than a bottle in the bottle holders. Other items may be thrown out of the holders in the event of an accident or sudden braking and cause injury.

**⚠ NOTICE**

**■ Items that should not be stowed in the bottle holders**

Put the cap on before stowing a bottle. Do not place open bottles in the bottle holders, or glasses and paper cups containing liquid. The contents may spill and glasses may break.

## Auxiliary box

### ► Type A

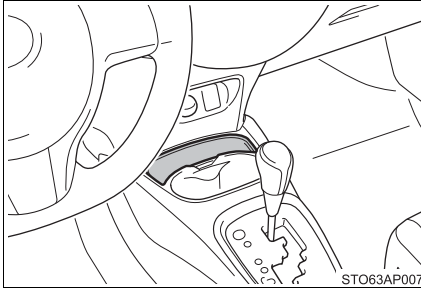

### ► Type B

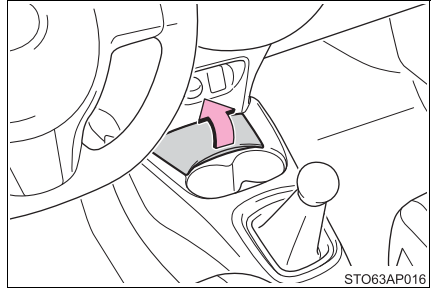

Open the cover.

### ► Type C

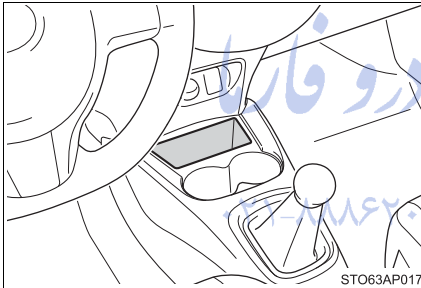

### ⚠ WARNING

#### ■ Caution while driving (Type B)

Keep the auxiliary boxes closed. In the event of sudden braking, an accident may occur due to an occupant being struck by an open auxiliary box or the items stored inside.

## Luggage compartment features

### Luggage cover

The luggage cover can be removed by the following procedure:

- 1 Unhook the cords and return the luggage cover to horizontal position.

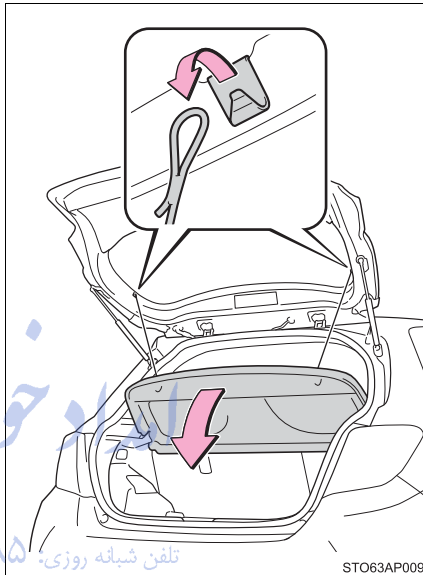

- 2 Lift the luggage cover and pull it toward you to remove it.

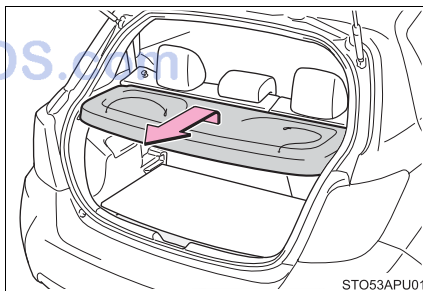

## Deck board (if equipped)

### ■ Deck board height adjustment

- ① Upper position
- ② Lower position

The lower position can be used when the deck board is placed on the luggage floor cover.

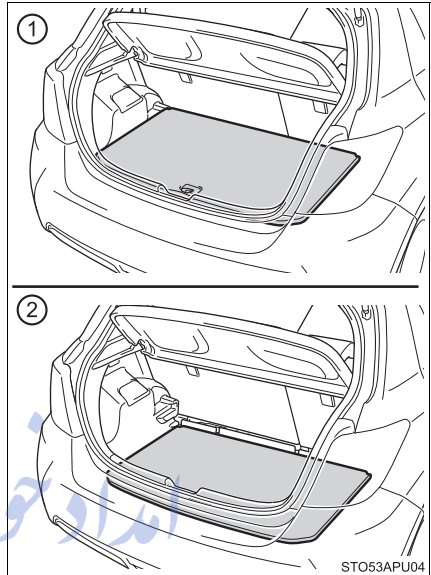

### ■ Removing the deck board

Lift up the deck board and pull it toward you to remove it.

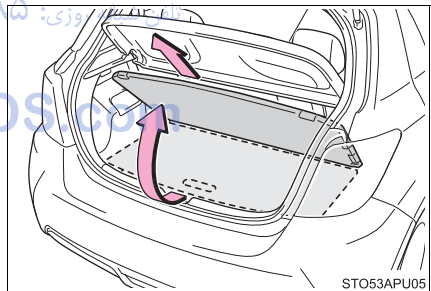

### ⚠ WARNING

#### ■ When operating the deck board

Do not place anything on the deck board when operating the board. Otherwise, your fingers may be caught or an accident may result causing injuries.

## Other interior feature

### Sun visors

- ① To set the visor in the forward position, flip it down.
- ② To set the visor in the side position, flip down, unhook, and swing it to the side.
- ③ To use the side extender, place the visor in the side position, then slide it backward. (if equipped)

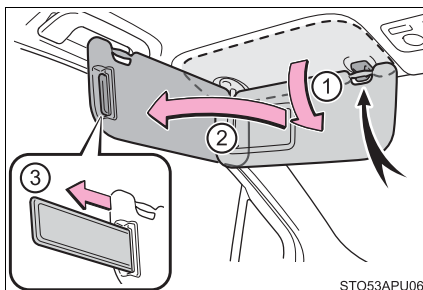

### Vanity mirrors

Slide the cover to open.

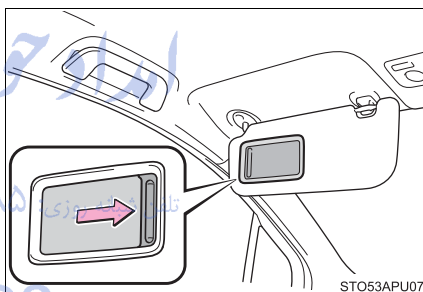

## Power outlet

Please use as a power supply for electronic goods that use less than 12 VDC/10 A (power consumption of 120 W).

Open the lid.

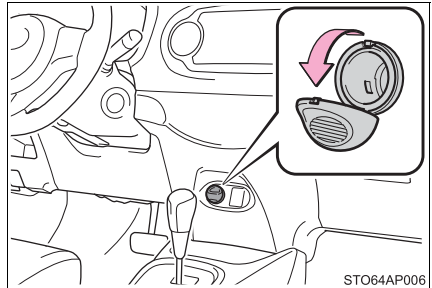

### ■ The power outlets can be used when

The engine switch is in the “ACC” or “ON” position.

#### ⚠ NOTICE

#### ■ To avoid damaging the power outlet

Close the power outlet lid when the power outlet is not in use. Foreign objects or liquids that enter the power outlet may cause a short circuit.

#### ■ To prevent battery discharge

Do not use the power outlet longer than necessary when the engine is not running.

FarmaSOS.com

## Assist grips

An assist grip installed on the ceiling can be used to support your body while sitting on the seat.

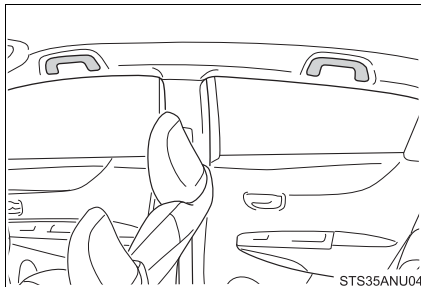

### WARNING

#### ■ Assist grip

Do not use the assist grip when getting in or out of the vehicle or rising from your seat.

Doing so could damage the assist grip, or could cause you to injure yourself by falling over.

### NOTICE

#### ■ To prevent damage to the assist grip

Do not hang any heavy object or put a heavy load on the assist grip.



## Maintenance and care

# 6

### 6-1. Maintenance and care

- Cleaning and protecting the vehicle exterior..... 194
- Cleaning and protecting the vehicle interior..... 197

### 6-2. Maintenance

- Maintenance requirements ..... 200
- General maintenance..... 202
- Emission inspection and maintenance (I/M) program ..... 205

### 6-3. Do-it-yourself maintenance

- Do-it-yourself service precautions ..... 206
- Hood ..... 209
- Positioning a floor jack ..... 211
- Engine compartment..... 213
- Tires ..... 223
- Tire inflation pressure ..... 231
- Wheels ..... 235
- Air conditioning filter..... 238
- Wireless remote control battery ..... 240
- Checking and replacing fuses ..... 243
- Light bulbs..... 248

## Cleaning and protecting the vehicle exterior

### Perform the following to protect the vehicle and maintain it in prime condition:

- Working from top to bottom, liberally apply water to the vehicle body, wheel wells and underside of the vehicle to remove any dirt and dust.
- Wash the vehicle body using a sponge or soft cloth, such as a chamois.
- For hard-to-remove marks, use car wash soap and rinse thoroughly with water.
- Wipe away any water.
- Wax the vehicle when the waterproof coating deteriorates.

If water does not bead on a clean surface, apply wax when the vehicle body is cool.

#### ■ Automatic car washes

- Fold the mirrors and remove the antenna before washing the vehicle. Start washing from the front of the vehicle. Make sure to re-install the antenna and extend the mirrors before driving.
- Brushes used in automatic car washes may scratch the vehicle surface and harm your vehicle's paint.
- Rear spoiler (if equipped) may not be washable in some automatic car washes. There may also be an increased risk of damage to vehicle.

#### ■ High pressure car washes

- Do not allow the nozzles of the car wash to come within close proximity of the windows and door borders, and high mounted stoplight.
- Before using the car wash, check that the fuel filler door on your vehicle is closed properly.

**■ Aluminum wheels (if equipped)**

- Remove any dirt immediately by using a neutral detergent. Do not use hard brushes or abrasive cleaners. Do not use strong or harsh chemical cleaners.  
Use the same mild detergent and wax as used on the paint.
- Do not use detergent on the wheels when they are hot, for example after driving for long distance in the hot weather.
- Wash detergent from the wheels immediately after use.
- To preserve the wheels' luster, do not allow hot water, such as from steam cleaning, to contact them directly.

**■ Bumpers**

Do not scrub with abrasive cleaners.

**⚠ WARNING****■ When washing the vehicle**

Do not apply water to the inside of the engine compartment. Doing so may cause the electrical components, etc. to catch fire.

**■ Precautions regarding the exhaust pipes**

Exhaust gases cause the exhaust pipes to become quite hot.

When washing the vehicle, be careful not to touch the pipes until they have cooled sufficiently, as touching hot exhaust pipes can cause burns.

تلفن شبانه روزی: ۰۲۱-۸۸۶۲۰۸۵

FarmaSOS.com

**NOTICE****■ To prevent paint deterioration and corrosion on the body and components (aluminum wheels etc.)**

- Wash the vehicle immediately in the following cases:
  - After driving near the sea coast
  - After driving on salted roads
  - If coal tar or tree sap is present on the paint surface
  - If dead insects, insect droppings or bird droppings are present on the paint surface
  - After driving in an area contaminated with soot, oily smoke, mine dust, iron powder or chemical substances
  - If the vehicle becomes heavily soiled with dust or mud
  - If liquids such as benzene and gasoline are spilled on the paint surface
- If the paint is chipped or scratched, have it repaired immediately.
- To prevent the wheels from corroding, remove any dirt and store in a place with low humidity when storing the wheels.

**■ Cleaning the exterior lights**

- Wash carefully. Do not use organic substances or scrub with a hard brush. This may damage the surfaces of the lights.
- Do not apply wax to the surfaces of the lights. Wax may cause damage to the lenses.

**■ Antenna installation and removal precautions**

- Before driving, ensure that the antenna is installed.
- When the antenna is removed, such as before entering an automatic car wash, make sure to store it in a suitable place so as not to lose it. Also, before driving, make sure to reinstall the antenna in its original position.

**■ To prevent damage to the antenna**

Remove the antenna in the following situations:

- When the antenna will touch the ceiling of a garage or other such places
- When a car cover is to be used to cover the vehicle

## Cleaning and protecting the vehicle interior

**The following procedures will help protect your vehicle's interior and keep it in top condition:**

### Protecting the vehicle interior

Remove dirt and dust using a vacuum cleaner. Wipe dirty surfaces with a cloth dampened with lukewarm water.

### Cleaning the leather areas

- Remove dirt and dust using a vacuum cleaner.
- Wipe off any excess dirt and dust with a soft cloth dampened with diluted detergent.  
Use a diluted water solution of approximately 5% neutral wool detergent.
- Wring out any excess water from the cloth and thoroughly wipe off all remaining traces of detergent.
- Wipe the surface with a dry, soft cloth to remove any remaining moisture. Allow the leather to dry in a shaded and ventilated area.

### Cleaning the synthetic leather areas

- Remove loose dirt using a vacuum cleaner.
- Apply a mild soap solution to the synthetic leather using a sponge or soft cloth.
- Allow the solution to soak in for a few minutes. Remove the dirt and wipe off the solution with a clean, damp cloth.

**■ Caring for leather areas**

Toyota recommends cleaning the interior of the vehicle at least twice a year to maintain the quality of the vehicle's interior.

**■ Shampooing the carpets**

There are several commercial foaming-type cleaners available. Use a sponge or brush to apply the foam. Rub in overlapping circles. Do not use water. Wipe dirty surfaces and let them dry. Excellent results are obtained by keeping the carpet as dry as possible.

**■ Seat belts**

Clean with mild soap and lukewarm water using a cloth or sponge. Also check the belts periodically for excessive wear, fraying or cuts.

**WARNING****■ Water in the vehicle**

- Do not splash or spill liquid in the vehicle.  
Doing so may cause electrical components, etc., to malfunction or catch fire.
- Do not get any of the SRS components or wiring in the vehicle interior wet.  
(→P. 35)  
An electrical malfunction may cause the airbags to deploy or not function properly, resulting in death or serious injury.

**■ Cleaning the interior (especially instrument panel)**

Do not use a polish wax or polish cleaner. The instrument panel may reflect off the windshield, obstructing the driver's view and leading to an accident, resulting in death or serious injury.



## NOTICE

### ■ Cleaning detergents

- Do not use the following types of detergent, as they may discolor the vehicle interior or cause streaks or damage to painted surfaces:
  - Non-seat portions: Organic substances such as benzene or gasoline, alkaline or acidic solutions, dye, and bleach
  - Seats: Alkaline or acidic solutions, such as thinner, benzene, and alcohol
- Do not use a polish wax or polish cleaner. The instrument panel's or other interior part's painted surface may be damaged.

### ■ Preventing damage to leather surfaces

Observe the following precautions to avoid damage to and deterioration of leather surfaces:

- Remove any dust or dirt from leather surfaces immediately.
- Do not expose the vehicle to direct sunlight for extended periods of time. Park the vehicle in the shade, especially during summer.
- Do not place items made of vinyl, plastic, or containing wax on the upholstery, as they may stick to the leather surface if the vehicle interior heats up significantly.

### ■ Water on the floor

Do not wash the vehicle floor with water.

Vehicle systems such as the audio system may be damaged if water comes into contact with electrical components such as the audio system above or under the floor of the vehicle. Water may also cause the body to rust.

### ■ Cleaning the inside of the rear window

- Do not use glass cleaner to clean the rear window, as this may cause damage to the rear window defogger heater wires. Use a cloth dampened with lukewarm water to gently wipe the window clean. Wipe the window in strokes running parallel to the heater wires.
- Be careful not to scratch or damage the heater wires.

## Maintenance requirements

**To ensure safe and economical driving, day-to-day care and regular maintenance are essential. It is the owner's responsibility to perform regular checks. Toyota recommends the following maintenance:**

### General maintenance

General maintenance should be performed on a daily basis. This can be done by yourself or by a Toyota dealer.

### Scheduled maintenance

Scheduled maintenance should be performed at specified intervals according to the maintenance schedule.

For details about maintenance items and schedules, refer to the "Scheduled Maintenance Guide" or "Owner's Manual Supplement".

### Do-it-yourself maintenance

You can perform some maintenance procedures by yourself.

Please be aware that do-it-yourself maintenance may affect warranty coverage.

The use of Toyota Repair Manuals is recommended.

For details about warranty coverage, see the separate "Owner's Warranty Information Booklet" or "Owner's Manual Supplement".

### Repair and replacement

It is recommended that genuine Toyota parts be used for repairs to ensure performance of each system. If non-Toyota parts are used in replacement or if a repair shop other than a Toyota dealer performs repairs, confirm the warranty coverage.



### ■ Reset the maintenance data (except Canada)

After the required maintenance is performed according to the maintenance schedule, please reset the maintenance data.

To reset the data, follow the procedures described below:

- 1 Switch the display to the trip meter "A" when the engine is running. (→P. 78)
- 2 Turn the engine switch to the "LOCK" position.
- 3 While pressing the display change button (→P. 79), turn the engine switch to the "ON" position (do not start the engine because reset mode will be canceled). Continue to press and hold the button until the trip meter displays "000000".

### ■ Allow inspection and repairs to be performed by a Toyota dealer

- Toyota technicians are well-trained specialists and are kept up to date with the latest service information. They are well informed about the operations of all systems on your vehicle.
- Keep a copy of the repair order. It proves that the maintenance that has been performed is under warranty coverage. If any problem should arise while your vehicle is under warranty, your Toyota dealer will promptly take care of it.

#### WARNING

#### ■ If your vehicle is not properly maintained

Improper maintenance could result in serious damage to the vehicle and possible death or serious injury.

#### ■ Handling of the battery

- Engine exhaust, some of its constituents, and a wide variety of automobile components contain or emit chemicals known to the State of California to cause cancer and birth defects and other reproductive harm. Work in a well ventilated area.
- Oils, fuels and fluids contained in vehicles as well as waste produced by component wear contain or emit chemicals known to the State of California to cause cancer and birth defects or other reproductive harm. Avoid exposure and wash any affected area immediately.
- Battery posts, terminals and related accessories contain lead and lead compounds which are known to cause brain damage. Wash your hands after handling. (→P. 219)

## General maintenance

Listed below are the general maintenance items that should be performed at the intervals specified in the “Owner’s Warranty Information Booklet” or “Owner’s Manual Supplement/Scheduled Maintenance Guide”. It is recommended that any problem you notice should be brought to the attention of your Toyota dealer or qualified service shop for advice.

### Engine compartment

Items	Check points
Battery	Check the battery fluid and connections. (→P. 219)
Brake fluid	Is the brake fluid at the correct level? (→P. 218)
Engine coolant	Is the engine coolant at the correct level?(→P. 216)
Engine oil	Is the engine oil at the correct level? (→P. 214)
Exhaust system	There should not be any fumes or strange sounds.
Radiator/condenser	The radiator and condenser should be free from foreign objects. (→P. 218)
Washer fluid	Is there sufficient washer fluid? (→P. 221)

## Vehicle interior

Items	Check points
Accelerator pedal	<ul style="list-style-type: none"> <li>The accelerator pedal should move smoothly (without uneven pedal effort or catching).</li> </ul>
Automatic transmission "Park" mechanism	<ul style="list-style-type: none"> <li>When parked on a slope and the shift lever is in P, is the vehicle securely stopped?</li> </ul>
Brake pedal	<ul style="list-style-type: none"> <li>Does the brake pedal move smoothly?</li> <li>Does the brake pedal have appropriate clearance from the floor? (→P. 314)</li> <li>Does the brake pedal have the correct amount of free play? (→P. 314)</li> </ul>
Brakes	<ul style="list-style-type: none"> <li>The vehicle should not pull to one side when the brakes are applied.</li> <li>The brakes should work effectively.</li> <li>The brake pedal should not feel spongy.</li> <li>The brake pedal should not get too close to the floor when the brakes are applied.</li> </ul>
Clutch pedal	<ul style="list-style-type: none"> <li>Does the clutch pedal move smoothly?</li> <li>Does the clutch pedal have appropriate clearance from the floor?</li> <li>Does the clutch pedal have the correct amount of free play? (→P. 313)</li> </ul>
Head restraints	<ul style="list-style-type: none"> <li>Do the head restraints move smoothly and lock securely?</li> </ul>
Indicators/buzzers	<ul style="list-style-type: none"> <li>Do the indicators and buzzers function properly?</li> </ul>
Lights	<ul style="list-style-type: none"> <li>Do all the lights come on?</li> </ul>
Parking brake	<ul style="list-style-type: none"> <li>Does the parking brake lever move smoothly?</li> <li>When parked on a slope and the parking brake is on, is the vehicle securely stopped?</li> </ul>

Items	Check points
Seat belts	<ul style="list-style-type: none"> <li>• Do the seat belts operate smoothly?</li> <li>• The seat belts should not be damaged.</li> </ul>
Seats	<ul style="list-style-type: none"> <li>• Do the seat controls operate properly?</li> </ul>
Steering wheel	<ul style="list-style-type: none"> <li>• Does the steering wheel rotate smoothly?</li> <li>• Does the steering wheel have the correct amount of free play?</li> <li>• There should not be any strange sounds coming from the steering wheel.</li> </ul>

### Vehicle exterior

Items	Check points
Doors	<ul style="list-style-type: none"> <li>• Do the doors operate smoothly?</li> </ul>
Engine hood	<ul style="list-style-type: none"> <li>• Does the engine hood lock system work properly?</li> </ul>
Fluid leaks	<ul style="list-style-type: none"> <li>• There should not be any signs of fluid leakage after the vehicle has been parked.</li> </ul>
Tire	<ul style="list-style-type: none"> <li>• Is the tire inflation pressure correct?</li> <li>• The tires should not be damaged or excessively worn.</li> <li>• Have the tires been rotated according to the maintenance schedule?</li> <li>• The wheel nuts should not be loose.</li> </ul>



**WARNING**

FarmaSOS.com

#### ■ If the engine is running

Turn the engine off and ensure that there is adequate ventilation before performing maintenance checks.

## Emission inspection and maintenance (I/M) programs

**Some states have vehicle emission inspection programs which include OBD (On Board Diagnostics) checks. The OBD system monitors the operation of the emission control system.**

### **If the malfunction indicator lamp comes on**

The OBD system determines that a problem exists somewhere in the emission control system. Your vehicle may not pass the I/M test and may need to be repaired. Contact your Toyota dealer to service the vehicle.

### **Your vehicle may not pass the I/M test in the following situations:**

- When the battery is disconnected or discharged  
Readiness codes that are set during ordinary driving are erased. Also, depending on your driving habits, the readiness codes may not be completely set.
- When the fuel tank cap is loose  
The malfunction indicator lamp comes on indicating a temporary malfunction and your vehicle may not pass the I/M test.

### **When the malfunction indicator lamp still remains on after several driving trips**

The error code in the OBD system will not be cleared unless the vehicle is driven 40 or more times.

### **If your vehicle does not pass the I/M test**

Contact your Toyota dealer to prepare the vehicle for re-testing.

## Do-it-yourself service precautions

**If you perform maintenance by yourself, be sure to follow the correct procedure as given in these sections.**

Items	Parts and tools
Battery condition (→P. 219)	<ul style="list-style-type: none"> <li>• Warm water</li> <li>• Baking soda</li> <li>• Grease</li> <li>• Conventional wrench (for terminal clamp bolts)</li> <li>• Distilled water</li> </ul>
Brake fluid level (→P. 218)	<ul style="list-style-type: none"> <li>• FMVSS No.116 DOT 3 or SAE J1703 brake fluid</li> <li>• Rag or paper towel</li> <li>• Funnel (used only for adding brake fluid)</li> </ul>
Engine coolant level (→P. 216)	<ul style="list-style-type: none"> <li>• “Toyota Super Long Life Coolant” or a similar high quality ethylene glycol-based non-silicate, non-amine, non-nitrite and non-borate coolant with long-life hybrid organic acid technology               <ul style="list-style-type: none"> <li>▶ Except Canada</li> <li>“Toyota Super Long Life Coolant” is pre-mixed with 50% coolant and 50% deionized water.</li> <li>▶ Canada</li> <li>“Toyota Super Long Life Coolant” is pre-mixed with 55% coolant and 45% deionized water.</li> </ul> </li> <li>• Funnel (used only for adding engine coolant)</li> </ul>
Engine oil level (→P. 214)	<ul style="list-style-type: none"> <li>• “Toyota Genuine Motor Oil” or equivalent</li> <li>• Rag or paper towel</li> <li>• Funnel (used only for adding engine oil)</li> </ul>

Items	Parts and tools
Fuses (→P. 243)	<ul style="list-style-type: none"> <li>• Fuse with same amperage rating as original</li> </ul>
Light bulbs (→P. 248)	<ul style="list-style-type: none"> <li>• Bulb with same number and wattage rating as original</li> <li>• Phillips-head screwdriver</li> <li>• Flathead screwdriver</li> <li>• Wrench</li> </ul>
Radiator and condenser (→P. 218)	—
Tire inflation pressure (→P. 231)	<ul style="list-style-type: none"> <li>• Tire pressure gauge</li> <li>• Compressed air source</li> </ul>
Washer fluid (→P. 221)	<ul style="list-style-type: none"> <li>• Water or washer fluid containing antifreeze (for winter use)</li> <li>• Funnel (used only for adding water or washer fluid)</li> </ul>
Windshield wiper/ rear window wiper	<ul style="list-style-type: none"> <li>• The wiper blades should not show any signs of cracking, splitting, wear, contamination or deformation.</li> <li>• The wiper blades should clear the windshield/rear window without streaking or skipping.</li> </ul>

تلفن شبانه روزی: ۰۲۱-۸۸۷۶۲۰۸۵

FarmaSOS.com

 **WARNING**

The engine compartment contains many mechanisms and fluids that may move suddenly, become hot, or become electrically energized. To avoid death or serious injury, observe the following precautions.

■ **When working on the engine compartment**

- Keep hands, clothing and tools away from the moving fan and engine drive belt.
- Be careful not to touch the engine, radiator, exhaust manifold, etc., right after driving as they may be hot. Oil and other fluids may also be hot.
- Do not leave anything that may burn easily, such as paper and rags, in the engine compartment.
- Do not smoke, cause sparks or expose an open flame to fuel on the battery. Fuel and battery fumes are flammable.
- Be extremely cautious when working on the battery. It contains poisonous and corrosive sulfuric acid.

■ **When working near the electric cooling fan or radiator grille**

Be sure the engine switch is in the "LOCK" position.

With the engine switch in the "ON" position, the electric cooling fan may automatically start to run if the air conditioning is on and/or the coolant temperature is high. (→P. 218)

■ **Safety glasses**

Wear safety glasses to prevent flying or falling material, fluid spray, etc. from getting in your eyes.

 **NOTICE**

FarmaSOS.com

■ **If you remove the air cleaner filter**

Driving with the air cleaner filter removed may cause excessive engine wear due to dirt in the air.



# Hood

## Release the lock from the inside of the vehicle to open the hood.

- 1 Pull the hood lock release lever.  
The hood will pop up slightly.

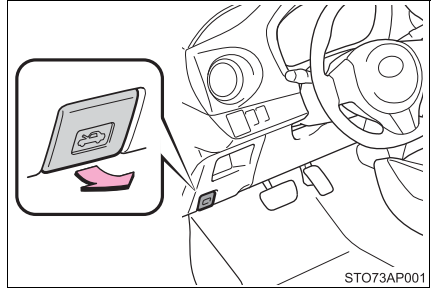

- 2 Pull up the auxiliary catch lever and lift the hood.

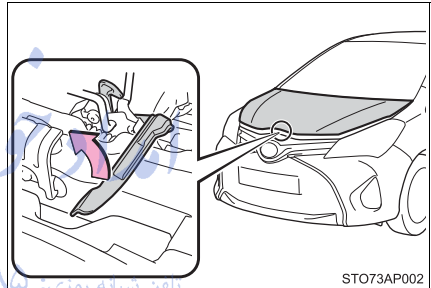

- 3 Hold the hood open by inserting the supporting rod into the slot.

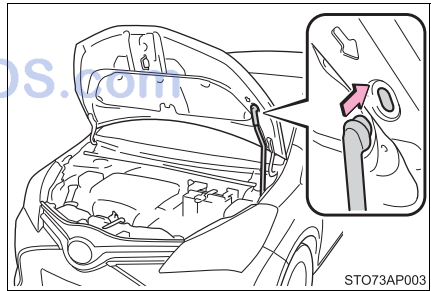

 **WARNING****■ Pre-driving check**

Check that the hood is fully closed and locked.

If the hood is not locked properly, it may open while the vehicle is in motion and cause an accident, which may result in death or serious injury.

**■ When opening the hood**

Make sure the rod supports the hood securely from falling down on to your head or body.

 **NOTICE****■ When closing the hood**

Be sure to return the support rod to its clip before closing the hood. Closing the hood without returning the support rod properly could cause the hood to bend.

امداد خودرو فارما

تلفن شبانه روزی: ۰۲۱-۸۸۶۲۰۸۵

FarmaSOS.com

## Positioning a floor jack

When using a floor jack, follow the instructions in the manual provided with the jack and perform the operation safely.

When raising your vehicle with a floor jack, position the jack correctly. Improper placement may damage your vehicle or cause injury.

### ◆ Front

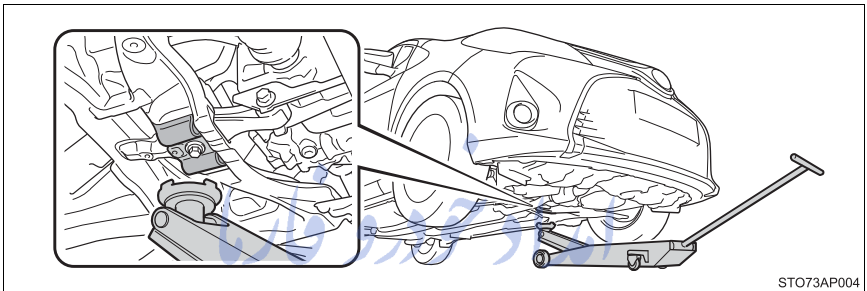

### ◆ Rear

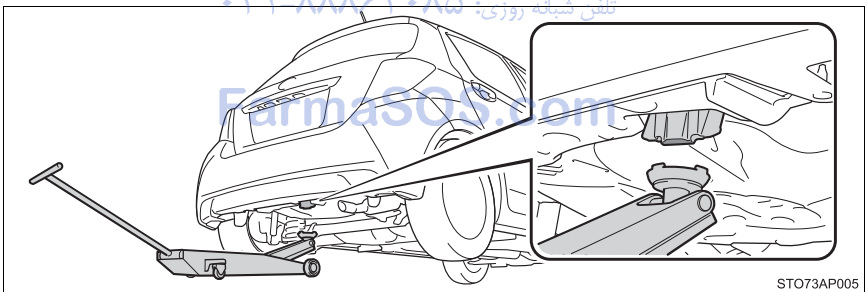



## NOTICE

**■ When raising your vehicle**

Do not jack the vehicle at the suspension. The suspension may be damaged.

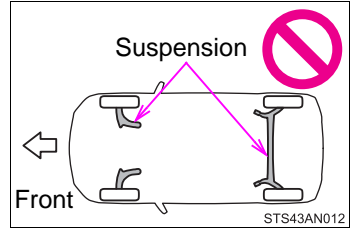

# امداد خودرو فارما

تلفن شبانه روزی: ۰۲۱-۸۸۸۶۲۰۸۵

[FarmaSOS.com](http://FarmaSOS.com)

## Engine compartment

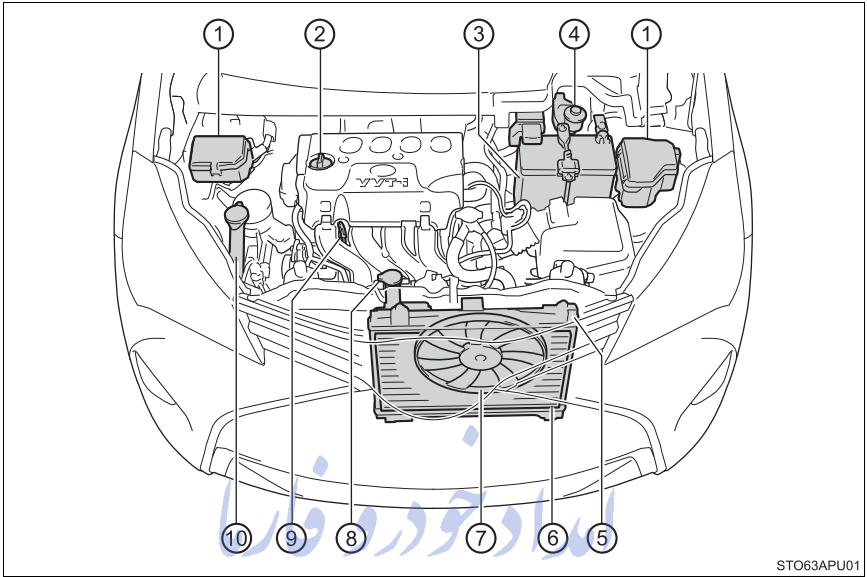

- |                         |           |                             |           |
|-------------------------|-----------|-----------------------------|-----------|
| ① Fuse boxes            | (→P. 243) | ⑥ Condenser                 | (→P. 218) |
| ② Engine oil filler cap | (→P. 215) | ⑦ Electric cooling fan      |           |
| ③ Battery               | (→P. 219) | ⑧ Engine coolant reservoir  | (→P. 216) |
| ④ Brake fluid reservoir | (→P. 218) | ⑨ Engine oil level dipstick | (→P. 214) |
| ⑤ Radiator              | (→P. 218) | ⑩ Washer fluid tank         | (→P. 221) |

## Engine oil

With the engine at operating temperature and turned off, check the oil level on the dipstick.

### ■ Checking the engine oil

- 1 Park the vehicle on level ground. After warming up the engine and turning it off, wait more than 5 minutes for the oil to drain back into the bottom of the engine.
- 2 Holding a rag under the end, pull the dipstick out.

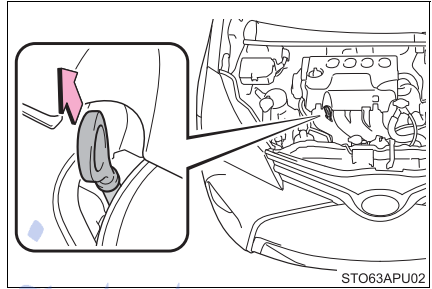

- 3 Wipe the dipstick clean.
- 4 Reinsert the dipstick fully.
- 5 Holding a rag under the end, pull the dipstick out and check the oil level.

- ① Low
- ② Normal
- ③ Excessive

The shape of the dipstick may differ depending on the type of vehicle or engine.

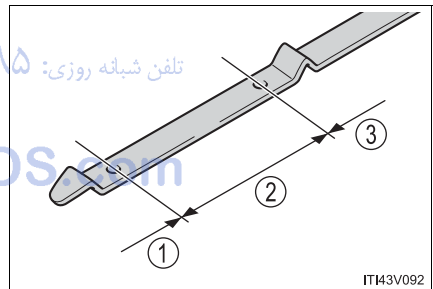

- 6 Wipe the dipstick and reinsert it fully.

## ■ Adding engine oil

If the oil level is below or near the low level mark, add engine oil of the same type as that already in the engine.

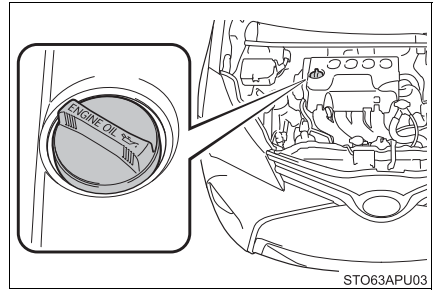

Make sure to check the oil type and prepare the items needed before adding oil.

Engine oil selection	→P. 310
Oil quantity (Low → Full)	1.6 qt. (1.5 L, 1.3 Imp.qt.)
Items	Clean funnel

- 1 Remove the oil filler cap by turning it counterclockwise.
- 2 Add engine oil slowly, checking the dipstick.
- 3 Install the oil filler cap by turning it clockwise.

## ■ Engine oil consumption

A certain amount of engine oil will be consumed while driving. In the following situations, oil consumption may increase, and engine oil may need to be refilled in between oil maintenance intervals.

- When the engine is new, for example directly after purchasing the vehicle or after replacing the engine
- If low quality oil or oil of an inappropriate viscosity is used
- When driving at high engine speeds or with a heavy load, or when driving while accelerating or decelerating frequently
- When leaving the engine idling for a long time, or when driving frequently through heavy traffic

## ⚠ WARNING

### ■ Used engine oil

- Used engine oil contains potentially harmful contaminants which may cause skin disorders such as inflammation and skin cancer, so care should be taken to avoid prolonged and repeated contact. To remove used engine oil from your skin, wash thoroughly with soap and water.
- Dispose of used oil and filters only in a safe and acceptable manner. Do not dispose of used oil and filters in household trash, in sewers or onto the ground.  
Call your Toyota dealer, service station or auto parts store for information concerning recycling or disposal.
- Do not leave used engine oil within the reach of children.

## ⚠ NOTICE

### ■ To prevent serious engine damage

Check the oil level on a regular basis.

### ■ When replacing the engine oil

- Be careful not to spill engine oil on the vehicle components.
- Avoid overfilling, or the engine could be damaged.
- Check the oil level on the dipstick every time you refill the vehicle.
- Be sure the engine oil filler cap is properly tightened.

## Engine coolant

The coolant level is satisfactory if it is between the “FULL” and “LOW” lines on the reservoir when the engine is cold.

- ① Reservoir cap
- ② “FULL” line
- ③ “LOW” line

If the level is on or below the “LOW” line, add coolant up to the “FULL” line. (→P. 300)

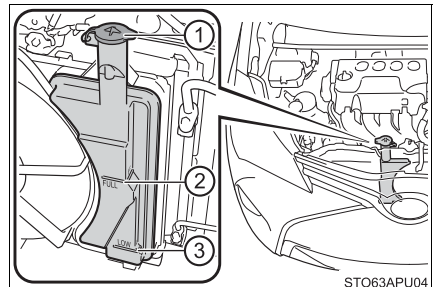



### ■ Coolant selection

Only use “Toyota Super Long Life Coolant” or a similar high quality ethylene glycol based non-silicate, non-amine, non-nitrite, and non-borate coolant with long-life hybrid organic acid technology.

#### ▶ Except Canada

“Toyota Super Long Life Coolant” is a mixture of 50% coolant and 50% deionized water. (Minimum temperature: -31°F [-35°C])

#### ▶ Canada

“Toyota Super Long Life Coolant” is a mixture of 55% coolant and 45% deionized water. (Minimum temperature: -44°F [-42°C])

For more details about coolant, contact your Toyota dealer.

### ■ If the coolant level drops within a short time of replenishing

Visually check the radiator, hoses, engine coolant reservoir caps, radiator cap, drain cock and water pump.

If you cannot find a leak, have your Toyota dealer test the cap and check for leaks in the cooling system.

### ⚠ WARNING

#### ■ When the engine is hot

Do not remove the radiator cap.

The cooling system may be under pressure and may spray hot coolant if the cap is removed, causing serious injuries, such as burns.

### ⚠ NOTICE

#### ■ When adding coolant

Coolant is neither plain water nor straight antifreeze. The correct mixture of water and antifreeze must be used to provide proper lubrication, corrosion protection and cooling. Be sure to read the antifreeze or coolant label.

#### ■ If you spill coolant

Be sure to wash it off with water to prevent it from damaging parts or paint.

## Radiator and condenser

Check the radiator and condenser and clear away any foreign objects. If any of the above parts is extremely dirty or you are not sure of their condition, have your vehicle inspected by your Toyota dealer.

### ⚠ WARNING

#### ■ When the engine is hot

Do not touch the radiator or condenser as they may be hot and cause serious injuries, such as burns.

## Brake fluid

### ■ Checking fluid level

The brake fluid level should be between the “MAX” and “MIN” lines on the tank.

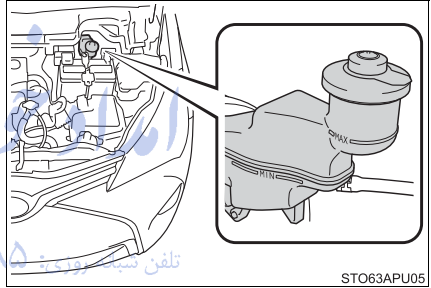

STO63APU05

### ■ Adding fluid

Make sure to check the fluid type and prepare the necessary item.

Fluid type	FMVSS No.116 DOT 3 or SAE J1703 brake fluid
Item	Clean funnel

### ■ Brake fluid can absorb moisture from the air

Excess moisture in the brake fluid can cause a dangerous loss of braking efficiency. Use only newly opened brake fluid.

### WARNING

#### ■ When filling the reservoir

Take care as brake fluid can harm your hands and eyes and damage painted surfaces.

If fluid gets on your hands or in your eyes, flush the affected area with clean water immediately.

If you still experience discomfort, consult a doctor.

### NOTICE

#### ■ If the fluid level is low or high

It is normal for the brake fluid level to go down slightly as the brake pads wear out or when the fluid level in the accumulator is high.

If the reservoir needs frequent refilling, there may be a serious problem.

## Battery

Check the battery as follows.

### ■ Battery exterior

Make sure that the battery terminals are not corroded and that there are no loose connections, cracks, or loose clamps.

- ① Terminals
- ② Hold-down clamp

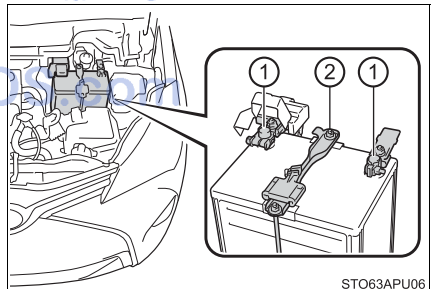

### ■ Before recharging

When recharging, the battery produces hydrogen gas which is flammable and explosive. Therefore, observe the following before recharging:

- If recharging with the battery installed on the vehicle, be sure to disconnect the ground cable.
- Make sure the power switch on the charger is off when connecting and disconnecting the charger cables to the battery.



### WARNING

#### ■ Chemicals in the battery

Batteries contain poisonous and corrosive sulfuric acid and may produce hydrogen gas which is flammable and explosive. To reduce the risk of death or serious injury, take the following precautions while working on or near the battery:

- Do not cause sparks by touching the battery terminals with tools.
- Do not smoke or light a match near the battery.
- Avoid contact with eyes, skin and clothes.
- Never inhale or swallow electrolyte.
- Wear protective safety glasses when working near the battery.
- Keep children away from the battery.

#### ■ Where to safely charge the battery

Always charge the battery in an open area. Do not charge the battery in a garage or closed room where there is insufficient ventilation.

#### ■ How to recharge the battery

Only perform a slow charge (5 A or less). The battery may explode if charged at a quicker rate.

## ⚠ WARNING

### ■ Emergency measures regarding electrolyte

- If electrolyte gets in your eyes  
Flush your eyes with clean water for at least 15 minutes and get immediate medical attention. If possible, continue to apply water with a sponge or cloth while traveling to the nearest medical facility.
- If electrolyte gets on your skin  
Wash the affected area thoroughly. If you feel pain or burning, get medical attention immediately.
- If electrolyte gets on your clothes  
It can soak through clothing on to your skin. Immediately take off the clothing and follow the procedure above if necessary.
- If you accidentally swallow electrolyte  
Drink a large quantity of water or milk. Get emergency medical attention immediately.

## ⚠ NOTICE

### ■ When recharging the battery

Never recharge the battery while the engine is running. Also, be sure all accessories are turned off.

## Washer fluid

If washer does not spray or the low washer fluid warning light comes on (if equipped), the washer tank may be empty. Add washer fluid.

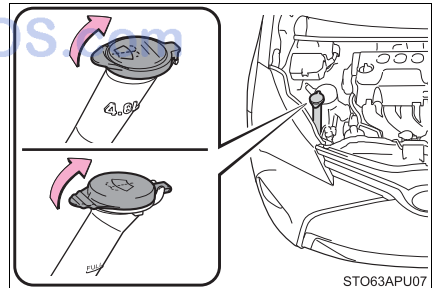

**WARNING****■ When adding washer fluid**

Do not add washer fluid when the engine is hot or running as washer fluid contains alcohol and may catch fire if spilled on the engine, etc.

**NOTICE****■ Do not use any fluid other than washer fluid**

Do not use soapy water or engine antifreeze instead of washer fluid. Doing so may cause streaking on the vehicle's painted surfaces.

**■ Diluting washer fluid**

Dilute washer fluid with water as necessary.

Refer to the freezing temperatures listed on the label of the washer fluid bottle.

امداد خودرو فارما

تلفن شبانه روزی: ۰۲۱-۸۸۶۲۰۸۵

FarmaSOS.com

## Tires

Replace or rotate tires in accordance with maintenance schedules and treadwear.

### Checking tires

- ① New tread
- ② Treadwear indicator
- ③ Worn tread

The location of treadwear indicators is shown by the "TWI" or "Δ" marks, etc., molded on the side-wall of each tire.

Check spare tire condition and pressure if not rotated.

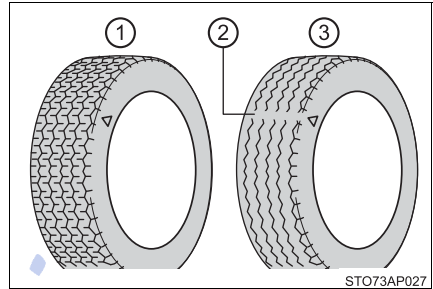

### Tire rotation

Rotate the tires in the order shown.

To equalize tire wear and extend tire life, Toyota recommends that tire rotation is carried out at the same interval as tire inspection.

Vehicles with P195/50R16 tires:

Do not fail to initialize the tire pressure warning system after tire rotation.

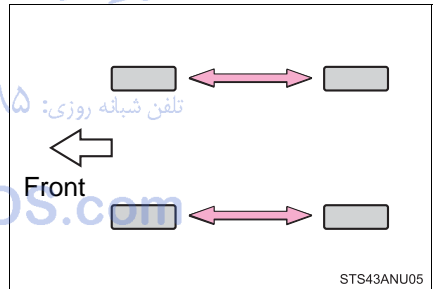

### **Tire pressure warning system (if equipped)**

Your vehicle is equipped with a tire pressure warning system that uses tire pressure warning valves and transmitters to detect low tire inflation pressure before serious problems arise. (→P. 274)

The compact spare tire is not equipped with a tire pressure warning valve and transmitter.

### **Installing tire pressure warning valves and transmitters (vehicles with a tire pressure warning system)**

When replacing tires or wheels, tire pressure warning valves and transmitters must also be installed.

When new tire pressure warning valves and transmitters are installed, new ID codes must be registered in the tire pressure warning computer and the tire pressure warning system must be initialized. Have tire pressure warning valve and transmitter ID codes registered by your Toyota dealer. (→P. 225)

#### **■ The tire pressure warning system must be initialized in the following circumstances:**

- For vehicles with P195/50R16 tires, when rotating front and rear tires which have different tire inflation pressures
- When the tire inflation pressure is changed such as when changing traveling speed

When the tire pressure warning system is initialized, the current tire inflation pressure is set as the benchmark pressure.



### ■ How to initialize the tire pressure warning system

- 1 Park the vehicle in a safe place and turn the engine switch to the "LOCK" position.

Initialization cannot be performed while the vehicle is moving.

- 2 Adjust the tire pressure to the specified cold tire inflation pressure level. (→P. 315)

Make sure to adjust the tire pressure to the specified cold tire inflation pressure level. The tire pressure warning system will operate based on this pressure level.

- 3 Turn the engine switch to the "ON" position.

- 4 Press and hold the tire pressure warning reset switch until the tire pressure warning light blinks slowly 3 times.

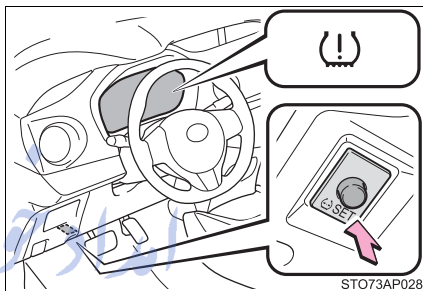

- 5 Wait for a few minutes with the engine switch in the "ON" position and then turn the engine switch to the "LOCK" position.

### Registering ID codes (vehicles with a tire pressure warning system)

The tire pressure warning valve and transmitter is equipped with a unique ID code. When replacing a tire pressure warning valve and transmitter, it is necessary to register the ID code. Have the ID code registered by your Toyota dealer.

**■ When to replace your vehicle's tires**

Tires should be replaced if:

- You have tire damage such as cuts, splits, cracks deep enough to expose the fabric, and bulges indicating internal damage
- A tire goes flat repeatedly or cannot be properly repaired due to the size or location of a cut or other damage

If you are not sure, consult with your Toyota dealer.

**■ Replacing tires and wheels (vehicles with a tire pressure warning system)**

If the ID code of the tire pressure warning valve and transmitter is not registered, the tire pressure warning system will not work properly. After driving for about 20 minutes, the tire pressure warning light blinks for 1 minute and stays on to indicate a system malfunction.

**■ Tire life**

Any tire over 6 years old must be checked by a qualified technician even if it has seldom or never been used or damage is not obvious.

**■ Routine tire inflation pressure checks (vehicles with a tire pressure warning system)**

The tire pressure warning system does not replace routine tire inflation pressure checks. Make sure to check tire inflation pressure as part of your routine of daily vehicle checks.

**■ Low profile tires (vehicles with 195/50R16 tires)**

Generally, low profile tires will wear more rapidly and tire grip performance will be reduced on snowy and/or icy roads when compared to standard tires. Be sure to use snow tires or tire chains on snowy and/or icy roads and drive carefully at a speed appropriate for road and weather conditions.

### ■ Maximum load of tire

Check that the maximum load of the replacement tire is greater than 1/2 of the Gross Axle Weight Ratings (GAWR) of either the front axle or the rear axle, whichever is greater.

For the GAWR, see the Certification Label. For the maximum load of the tire, see the load limit at maximum cold tire inflation pressure mentioned on the sidewall of the tire. (→P. 320)

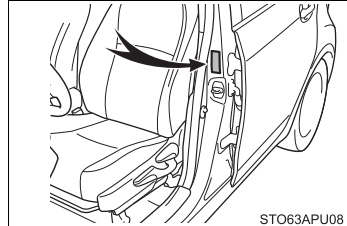

### ■ Tire types

#### ● Summer tires

Summer tires are high-speed performance tires best suited to highway driving under dry conditions. Since summer tires do not have the same traction performance as snow tires, summer tires are inadequate for driving on snow-covered or icy roads. For driving on snow-covered roads or icy roads, the use of snow tires is recommended. When installing snow tires, be sure to replace all four tires.

#### ● All season tires

All season tires are designed to provide better traction in snow and to be adequate for driving in most winter conditions as well as for use year-round. All season tires, however, do not have adequate traction performance compared with snow tires in heavy or loose snow. Also, all season tires fall short in acceleration and handling performance compared with summer tires in highway driving.

#### ● Snow tires

For driving on snow-covered roads or icy roads, we recommend using snow tires. If you need snow tires, select tires of the same size, construction and load capacity as the originally installed tires. Since your vehicle has radial tires as original equipment, make sure your snow tires also have radial construction. Do not install studded tires without first checking local regulations for possible restrictions. Snow tires should be installed on all wheels. (→P. 167)

■ **Initializing the tire pressure warning system (vehicles with a tire pressure warning system)**

Initialize the system with the tire inflation pressure adjusted to the specified level.

■ **If the tread on snow tires wears down below 0.16 in. (4 mm)**

The effectiveness of the tires as snow tires is lost.

■ **If you press the tire pressure warning reset switch accidentally (vehicles with a tire pressure warning system)**

If initialization is performed, adjust the tire inflation pressure to the specified level and initialize the tire pressure warning system again.

■ **When the initialization of the tire pressure warning system has failed (vehicles with a tire pressure warning system)**

Initialization can be completed in a few minutes. However, in the following cases, the settings has not been recorded and the system will not operate properly. If repeated attempts to record tire inflation pressure settings are unsuccessful, have the vehicle inspected by your Toyota dealer.

- When operating the tire pressure warning reset switch, the tire pressure warning light does not blink 3 times.

- After driving for a certain period of time since the initialization has been completed, the warning light comes on after blinks for 1 minute.

■ **Certification for the tire pressure warning system**

► For vehicles sold in U.S.A.

FCC ID: PAXPMVC010

FCC ID: HYQ23AAD

تلفن شبانه روزی: ۰۲۱-۸۸۶۲۰۸۵

**NOTE:**

This device complies with part 15 of the FCC Rules. Operation is subject to the following two conditions: (1) This device may not cause harmful interference, and (2) this device must accept any interference received, including interference that may cause undesired operation.

**FCC WARNING:**

Changes or modifications not expressly approved by the party responsible for compliance could void the user's authority to operate the equipment.

 **WARNING**
**■ When inspecting or replacing tires**

Observe the following precautions to prevent accidents.

Failure to do so may cause damage to parts of the drive train as well as dangerous handling characteristics, which may lead to an accident resulting in death or serious injury.

- Do not mix tires of different makes, models or tread patterns.  
Also, do not mix tires of remarkably different treadwear.
- Do not use tire sizes other than those recommended by Toyota.
- Do not mix differently constructed tires (radial, bias-belted or bias-ply tires).
- Do not mix summer, all season and snow tires.
- Do not use tires that have been used on another vehicle.  
Do not use tires if you do not know how they were used previously.
- Do not tow if your vehicle has a compact spare tire installed.

**■ When initializing the tire pressure warning system (vehicles with a tire pressure warning system)**

Do not operate the tire pressure warning reset switch without first adjusting the tire inflation pressure to the specified level. Otherwise, the tire pressure warning light may not come on even if the tire inflation pressure is low, or it may come on when the tire inflation pressure is actually normal.

تلفن شبکه روزی: ۰۲۱-۸۸۶۲۰۸۵

FarmaSOS.com



## NOTICE

■ **Repairing or replacing tires, wheels, tire pressure warning valves, transmitters and tire valve caps (vehicles with a tire pressure warning system)**

- When removing or fitting the wheels, tires or the tire pressure warning valves and transmitters, contact your Toyota dealer as the tire pressure warning valves and transmitters may be damaged if not handled correctly.
- When replacing tire valve caps, do not use tire valve caps other than those specified. The cap may become stuck.

■ **To avoid damage to the tire pressure warning valves and transmitters (vehicles with a tire pressure warning system)**

When a tire is repaired with liquid sealants, the tire pressure warning valve and transmitter may not operate properly. If a liquid sealant is used, contact your Toyota dealer or other qualified service shop as soon as possible. Make sure to replace the tire pressure warning valve and transmitter when replacing the tire. (→P. 224)

■ **Driving on rough roads**

Take particular care when driving on roads with loose surfaces or potholes.

These conditions may cause losses in tire inflation pressure, reducing the cushioning ability of the tires. In addition, driving on rough roads may cause damage to the tires themselves, as well as the vehicle's wheels and body.

■ **Low profile tires (vehicles with 195/50R16 tires)**

Low profile tires may cause greater damage than usual to the tire wheel when sustaining impact from the road surface. Therefore, pay attention to the following:

- Be sure to use proper tire inflation pressure. If tires are under-inflated, they may be damaged more severely.
- Avoid potholes, uneven pavement, curbs and other road hazards. Failure to do so may lead to severe tire and wheel damage.

■ **If tire inflation pressure of each tire becomes low while driving**

Do not continue driving, or your tires and/or wheels may be ruined.

## Tire inflation pressure

The recommended cold tire inflation pressure and tire size are displayed on the tire and loading information label. (→P. 315)

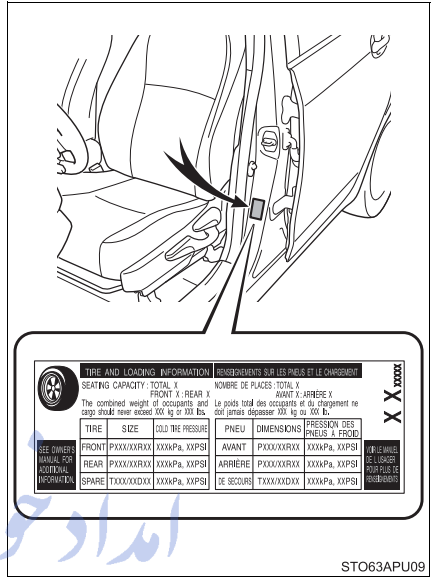

امداد خودرو فارما

تلفن شبانه روزی: ۰۲۱-۸۸۶۲۰۸۵

FarmaSOS.com

### Inspection and adjustment procedure

- ① Tire valve
- ② Tire pressure gauge

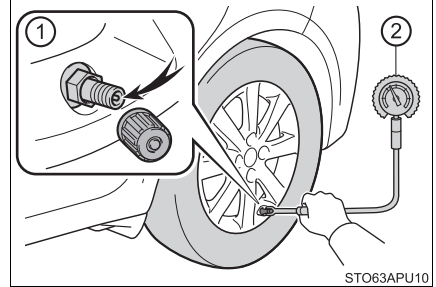

- 1 Remove the tire valve cap.
- 2 Press the tip of the tire pressure gauge onto the tire valve.
- 3 Read the pressure using the gauge gradations.
- 4 If the tire inflation pressure is not at the recommended level, adjust the pressure.  
If you add too much air, press the center of the valve to deflate.
- 5 After completing the tire inflation pressure measurement and adjustment, apply soapy water to the valve and check for leakage.
- 6 Put the tire valve cap back on.

تلفن شبانه روزی: ۰۲۱-۸۸۶۲۰۸۵

FarmaSOS.com



**■ Tire inflation pressure check interval**

You should check tire inflation pressure every two weeks, or at least once a month.

Do not forget to check the spare.

**■ Effects of incorrect tire inflation pressure**

Driving with incorrect tire inflation pressure may result in the following:

- Reduced fuel efficiency
- Reduced driving comfort and tire life
- Reduced safety
- Damage to the drive train

If a tire needs frequent inflating, have it checked by your Toyota dealer.

**■ Instructions for checking tire inflation pressure**

When checking tire inflation pressure, observe the following:

- Check only when the tires are cold.

If your vehicle has been parked for at least 3 hours or has not been driven for more than 1 mile or 1.5 km, you will get an accurate cold tire inflation pressure reading.

- Always use a tire pressure gauge.

The appearance of the tire can be misleading. In addition, tire inflation pressure that is even just a few pounds off can affect ride quality and handling.

- Do not reduce tire inflation pressure after driving. It is normal for tire inflation pressure to be higher after driving.

- Never exceed the vehicle capacity weight.

Passengers and luggage weight should be placed so that the vehicle is balanced.

**WARNING****■ Proper inflation is critical to save tire performance**

Keep your tires properly inflated. Otherwise, the following conditions may occur and result in an accident causing death or serious injury:

- Excessive wear
- Uneven wear
- Poor handling
- Possibility of blowouts resulting from overheated tires
- Poor sealing of the tire bead
- Wheel deformation and/or tire separation
- A greater possibility of tire damage from road hazards

**NOTICE****■ When inspecting and adjusting tire inflation pressure**

Be sure to put the tire valve caps back on.

Without the valve caps, dirt or moisture could get into the valve and cause air leakage, which could result in an accident. If the caps are lost, replace them as soon as possible.

تلفن شبانه روزی: ۰۲۱-۸۸۶۲۰۸۵

**FarmaSOS.com**

## Wheels

**If a wheel is bent, cracked or heavily corroded, it should be replaced. Otherwise, the tire may separate from the wheel or cause a loss of handling control.**

### Wheel selection

When replacing wheels, care should be taken to ensure that they are equivalent to those removed in load capacity, diameter, rim width and inset\*.

Replacement wheels are available at your Toyota dealer.

\*: Conventionally referred to as "offset".

Toyota does not recommend using the following:

- Wheels of different sizes or types
- Used wheels
- Bent wheels that have been straightened

### Aluminum wheel precautions (if equipped)

- Use only Toyota wheel nuts and wrenches designed for use with your aluminum wheels.
- When rotating, repairing or changing your tires, check that the wheel nuts are still tight after driving 1000 miles (1600 km).
- Be careful not to damage the aluminum wheels when using tire chains.
- Use only Toyota genuine balance weights or equivalent and a plastic or rubber hammer when balancing your wheels.

### ■ When replacing wheels (vehicles with a tire pressure warning system)

The wheels of your vehicle, except for the compact spare tire, are equipped with tire pressure warning valves and transmitters that allow the tire pressure warning system to provide advance warning in the event of a loss in tire inflation pressure. Whenever wheels are replaced, tire pressure warning valves and transmitters must be installed. (→P. 224)

#### ⚠ WARNING

#### ■ When replacing wheels

- Do not use wheels that are a different size from those recommended in the Owner's Manual, as this may result in a loss of handling control.
- Never use an inner tube in a leaking wheel which is designed for a tubeless tire. Doing so may result in an accident, causing death or serious injury.

#### ■ When installing the wheel nuts

- Be sure to install the wheel nuts with the tapered ends facing inward. Installing the nuts with the tapered ends facing outward can cause the wheel to break and eventually cause the wheel to come off while driving, which could lead to an accident resulting in death or serious injury.

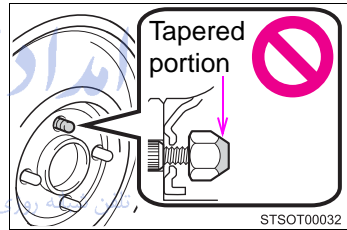

- Never use oil or grease on the wheel bolts or wheel nuts. Oil and grease may cause the wheel nuts to be excessively tightened, leading to bolt or disc wheel damage. In addition, the oil or grease can cause the wheel nuts to loosen and the wheel may fall off, causing an accident and resulting in death or serious injury. Remove any oil or grease from the wheel bolts or wheel nuts.

#### ■ Use of defective wheels prohibited

Do not use cracked or deformed wheels.

Doing so could cause the tire to leak air during driving, possibly causing an accident.



## NOTICE

**■ Replacing tire pressure warning valves and transmitters (vehicles with a tire pressure warning system)**

- Because tire repair or replacement may affect the tire pressure warning valves and transmitters, make sure to have tires serviced by your Toyota dealer or other qualified service shop. In addition, make sure to purchase your tire pressure warning valves and transmitters at your Toyota dealer.
- Ensure that only genuine Toyota wheels are used on your vehicle. Tire pressure warning valves and transmitters may not work properly with non-genuine wheels.

امداد خودرو فارما

تلفن شبانه روزی: ۰۲۱-۸۸۶۲۰۸۵

FarmaSOS.com

## Air conditioning filter

**The air conditioning filter must be changed regularly to maintain air conditioning efficiency.**

### Removal method

- 1 Turn the engine switch to the "LOCK" position.
- 2 Open the glove box and slide off the damper.

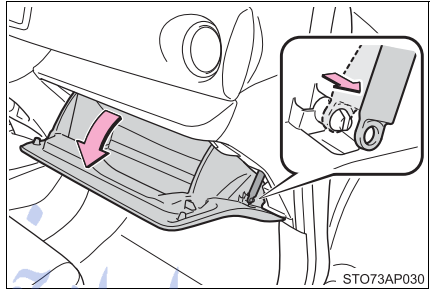

- 3 Push in each side of the glove box to disconnect the upper claws.

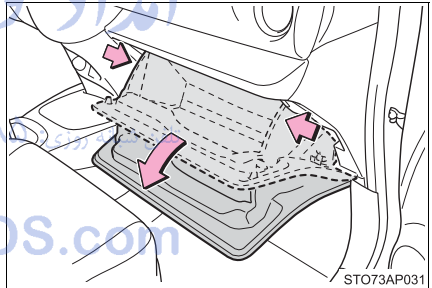

- 4 Pull out the glove box and disconnect the lower claws.

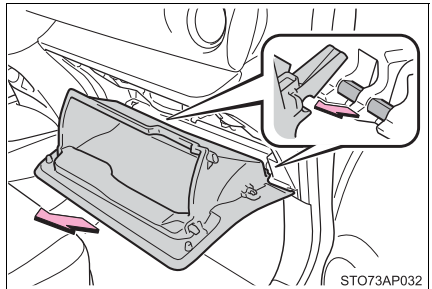

- 5 Remove the filter cover.

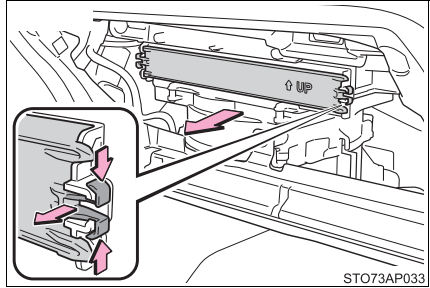

- 6 Remove the air conditioning filter and replace it with a new one.

The “↑UP” marks shown on the filter should be pointing up.

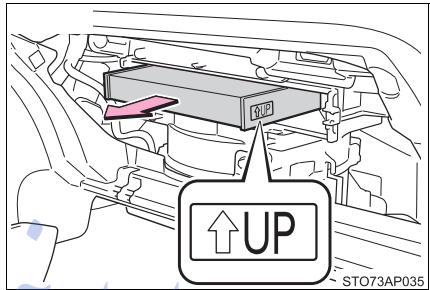

### ■ Checking interval

Inspect and replace the air conditioning filter according to the maintenance schedule. In dusty areas or areas with heavy traffic flow, early replacement may be required. (For scheduled maintenance information, please refer to the “Scheduled Maintenance Guide” or “Owner’s Manual Supplement”.)

### ■ If air flow from the vents decreases dramatically

The filter may be clogged. Check the filter and replace if necessary.

#### ⚠ NOTICE

#### ■ When using the air conditioning system

Make sure that a filter is always installed.

Using the air conditioning system without a filter may cause damage to the system.

## Wireless remote control battery\*

Replace the battery with a new one if it is depleted.

You will need the following items:

- Flathead screwdriver
- Lithium battery CR2016

### Replacing the battery

► Type A

**1** Remove the cover.

To prevent damage to the key, cover the tip of the screwdriver with a tape.

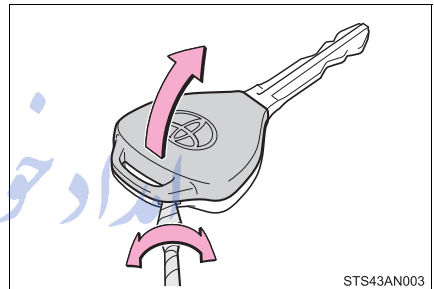

**2** Remove the module.

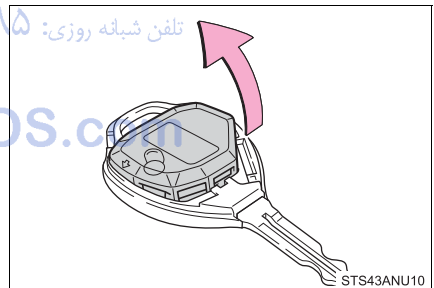

**3** Open the battery cover using a coin protected with tape etc., and remove the depleted battery.

Insert a new battery with the “+” terminal facing up.

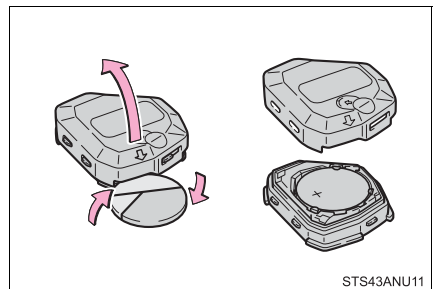

\*: If equipped



## ► Type B

**1** Remove the cover.

To prevent damage to the key, cover the tip of the screwdriver with a tape.

To prevent the buttons from being disassembled, face the button surface downward.

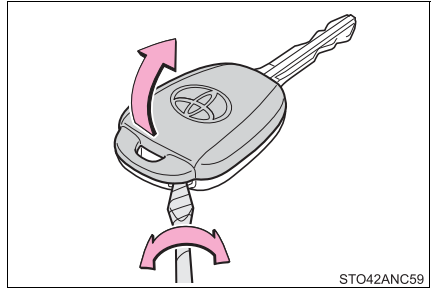
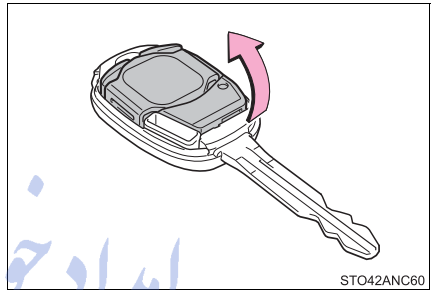
**2** Remove the module.**3** Open the case cover and remove the depleted battery.

Insert a new battery with the “+” terminal facing up.

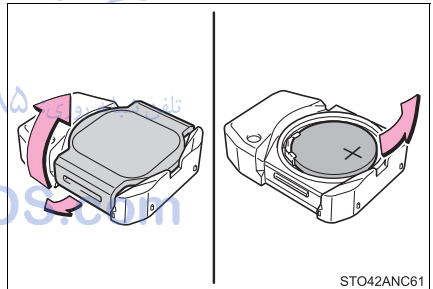

### ■ Use a CR2016 lithium battery

- Batteries can be purchased at your Toyota dealer, local electrical appliance shops or camera stores.
- Replace only with the same or equivalent type recommended by the manufacturer.
- Dispose of used batteries according to local laws.

### ■ If the key battery is depleted

The following symptoms may occur:

- The wireless remote control will not function properly.
- The operational range will be reduced.

### ■ When replacing the module (type B only)

Replace the module from right above. Replacing it from diagonally above may prevent the key buttons from operating properly.

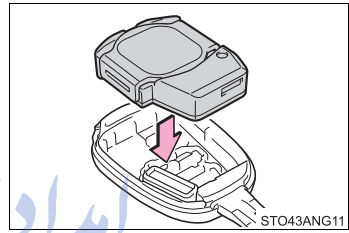

### ⚠ WARNING

#### ■ Removed battery and other parts

These parts are small and if swallowed by a child, they can cause choking. Keep away from children. Failure to do so could result in death or serious injury.

### ⚠ NOTICE

#### ■ For normal operation after replacing the battery

Observe the following precautions to prevent accidents:

- Always work with dry hands. Moisture may cause the battery to rust.
- Do not touch or move any other component inside the remote control.
- Do not bend either of the battery terminals.

## Checking and replacing fuses

If any of the electrical components do not operate, a fuse may have blown. If this happens, check and replace the fuses as necessary.

- 1 Turn the engine switch to the "LOCK" position.
- 2 Open the fuse box cover.
  - ▶ Engine compartment: type A and B fuse boxes

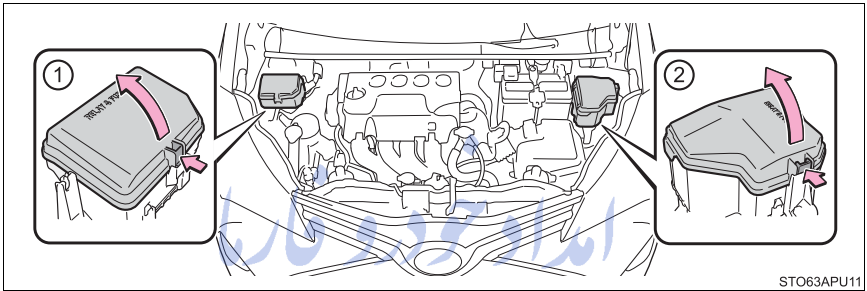

- 1 Type A fuse box

Push the tab in and lift the lid off. تلفن شبانه روزی: ۰۲۱۳۳۳۳۳۳۳۳

- 2 Type B fuse box

Push the tab in and lift the lid off. FarimasOS.com

► Engine compartment: type C fuse box

- ① Pull the rubber strip on the edge to unhook it from the cover, and then push the tabs in and lift the cover off.

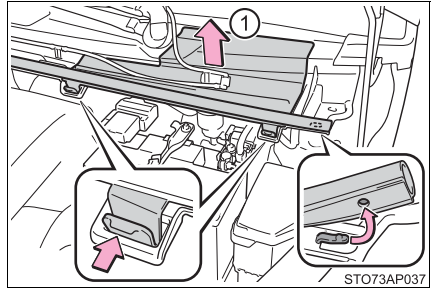

- ② Remove the battery terminal cover and then the fuse box cover.

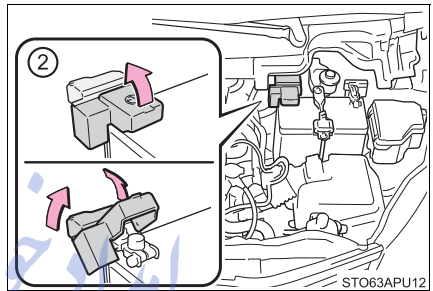

► Instrument panel

Remove the lid.

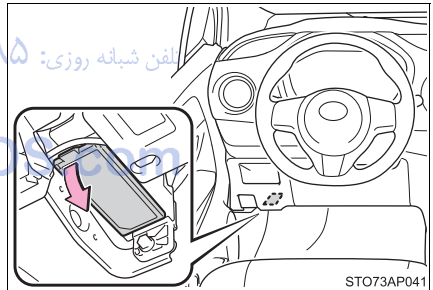

- ③ Remove the fuse with the pull-out tool.

Only type A fuse can be removed using the pullout tool.

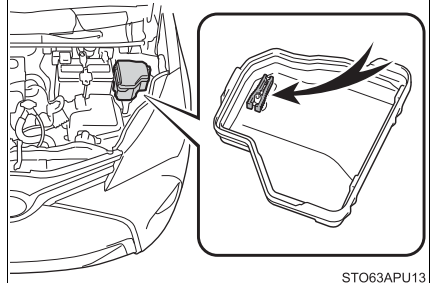

**4** Check if the fuse is blown.

① Normal fuse

② Blown fuse

From Type A to E:

Replace the blown fuse with a new fuse of an appropriate amperage rating. The amperage rating can be found on the fuse box lid.

Type F:

Contact your Toyota dealer.

► Type A

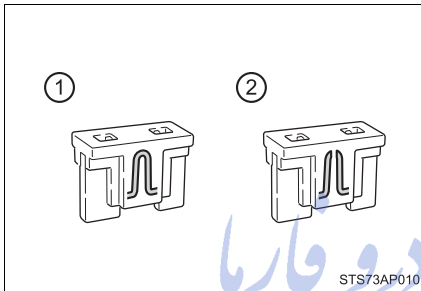

► Type B

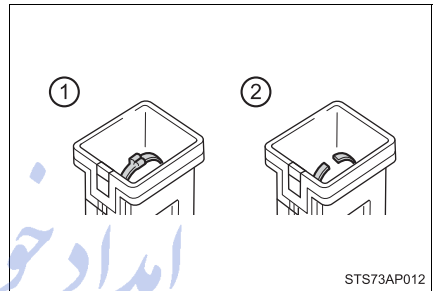

► Type C

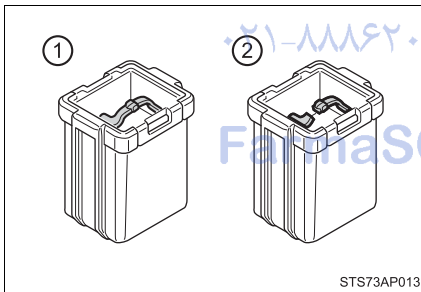

► Type D

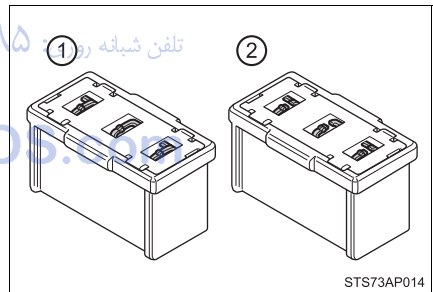

► Type E

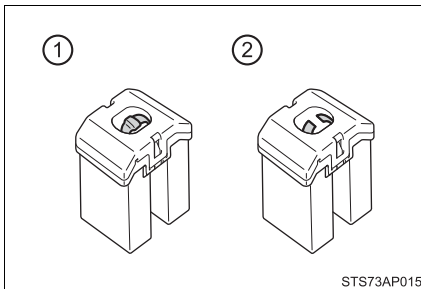

► Type F

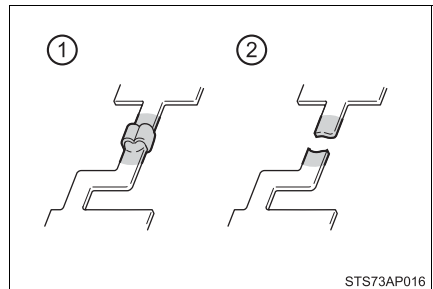

### ■ After a fuse is replaced

- If the lights do not turn on even after the fuse has been replaced, a bulb may need replacement. (→P. 248)
- If the replaced fuse blows again, have the vehicle inspected by your Toyota dealer.

### ■ If there is an overload in a circuit

The fuses are designed to blow, protecting the wiring harness from damage.

### ■ When replacing light bulbs

Toyota recommends that you use genuine Toyota products designed for this vehicle. Because certain bulbs are connected to circuits designed to prevent overload, non-genuine parts or parts not designed for this vehicle may be unusable.

### ■ When reinstalling the cover (type C fuse box)

Reinstall the cover, and then hook the rubber strip's groove onto the cover.

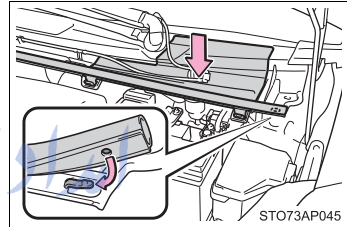

### WARNING

تلفن: شماره روزی: ۰۲۱-۸۸۶۲۰۸۵

### ■ To prevent system breakdowns and vehicle fire

Observe the following precautions.

Failure to do so may cause damage to the vehicle, and possibly a fire or injury.

- Never use a fuse of a higher amperage rating than that indicated, or use any other object in place of a fuse.
- Always use a genuine Toyota fuse or equivalent.  
Never replace a fuse with a wire, even as a temporary fix.
- Do not modify the fuses or fuse boxes.



## NOTICE

**■ Before replacing fuses**

Have the cause of electrical overload determined and repaired by your Toyota dealer as soon as possible.

امداد خودرو فارما

تلفن شبانه روزی: ۰۲۱-۸۸۶۲۰۸۵

FarmaSOS.com

## Light bulbs

You may replace the following bulbs by yourself. The difficulty level of replacement varies depending on the bulb. If necessary bulb replacement seems difficult to perform, contact your Toyota dealer.

For more information about replacing other light bulbs, contact your Toyota dealer.

### Preparing for light bulb replacement

Check the wattage of the light bulb to be replaced. (→P. 316)

### Bulb locations

#### ■ Front

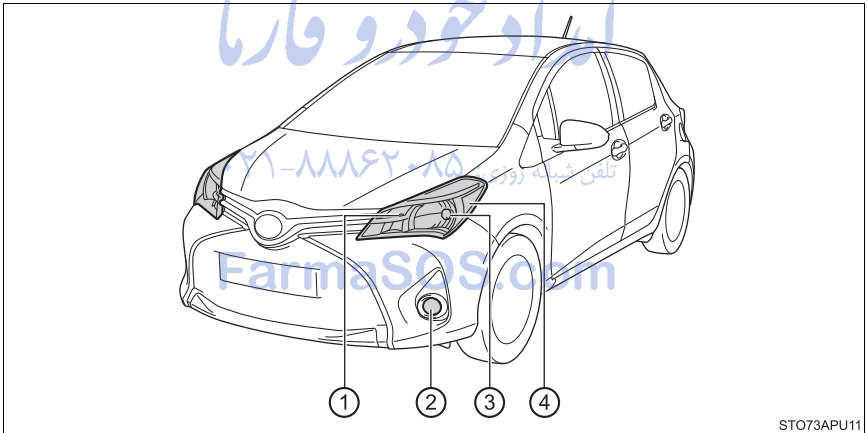

ST073APU11

- |   |   |
|---|---|
| ① Front turn signal lights/parking lights | ③ Headlights and daytime running lights (if equipped) |
| ② Front fog lights (if equipped)          | ④ Front side marker lights                            |



## ■ Rear

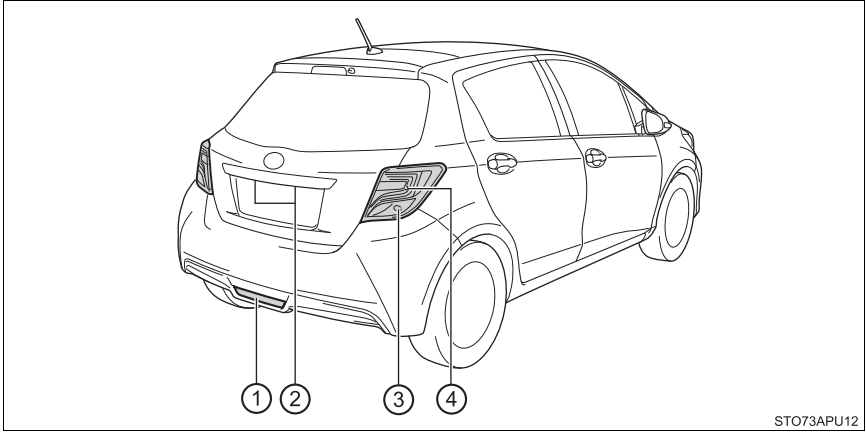

- ① Back-up lights                      ③ Rear turn signal lights  
 ② License plate lights              ④ Stop/tail and rear side marker lights

### Replacing light bulbs

#### ■ Headlights and daytime running lights (if equipped)

- Reflector type      تلفن شبانه روزی: ۰۲۱-۸۸۶۲۰۸۵

- 1 Unplug the connector.

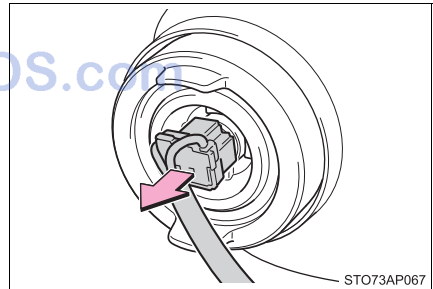

- 2 Remove the rubber cover.

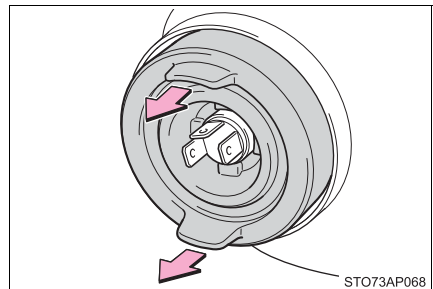

- 3 Release the bulb retaining spring.

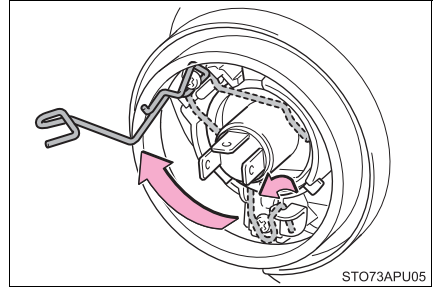

- 4 Remove the bulb.

When installing a new bulb, align tabs of the bulb with the cutouts of the mounting hole.

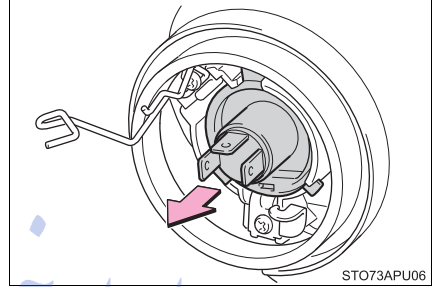

- 5 To install, reverse the steps listed.

► Projector type

- 1 Turn the bulb base counter-clockwise.

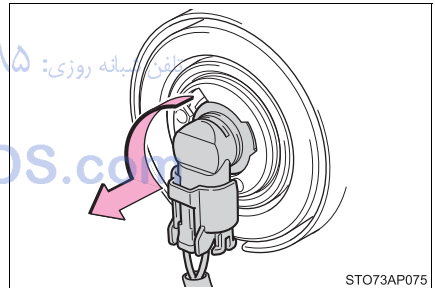

- 2 Pull the bulb out while pressing the lock release of the connector.

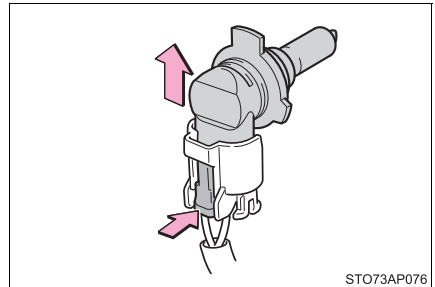

- 3 Replace the light bulb, and install the bulb base.

Align the 3 tabs on the light bulb with the mounting and insert.

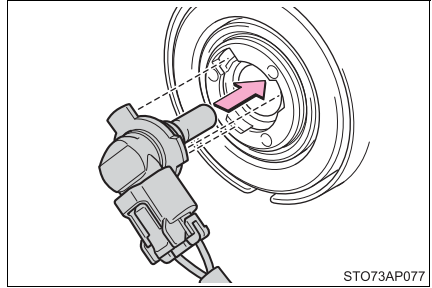

- 4 Turn and secure the bulb base.

Shake the bulb base gently to check that it is not loose, turn the headlights on once and visually confirm that no light is leaking through the mounting.

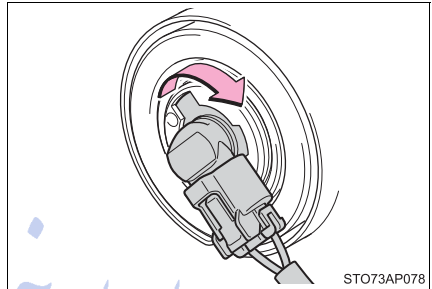

#### ■ Front fog lights (if equipped)

- 1 Remove the screws.

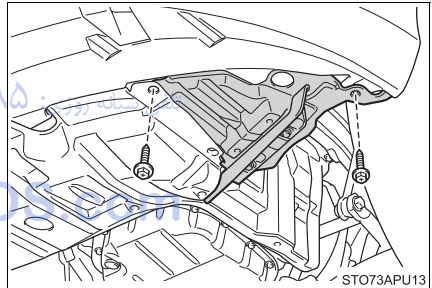

- 2 Remove the grommet.

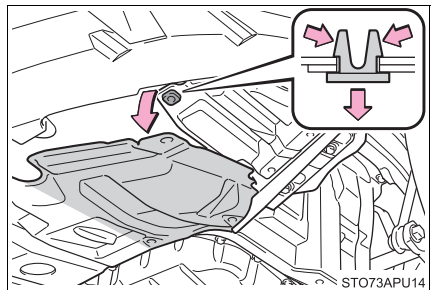

- 3 Partly remove the fender liner.

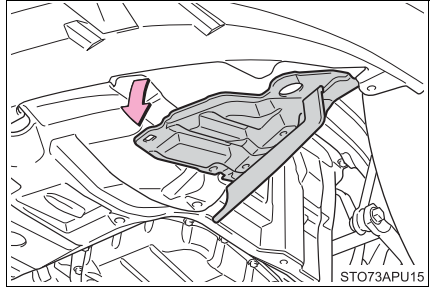

- 4 Unplug the connector while pressing the lock release.

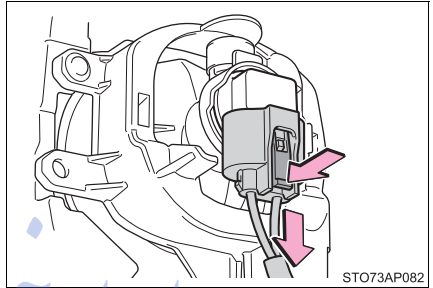

- 5 Turn the bulb base counter-clockwise and remove.

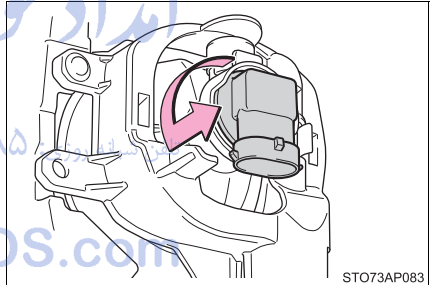

- 6 Set the new light bulb.

Align the 3 tabs on the light bulb with the mounting, and insert.

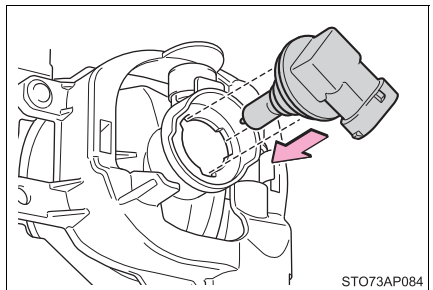

- 7 Turn and secure the bulb. Install the connector.

Shake the bulb base gently to check that it is not loose, turn the front fog light, on once and visually confirm that no light is leaking through the mounting.

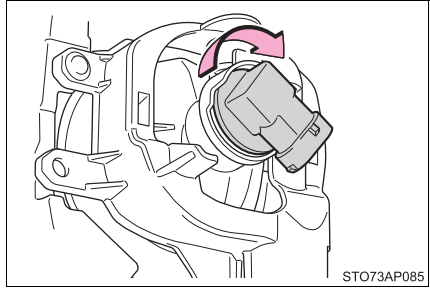

- 8 When installing the fender liner, install by starting 3 and the directions reversed.

### ■ Front side marker lights

- 1 Turn the bulb base counter-clockwise.

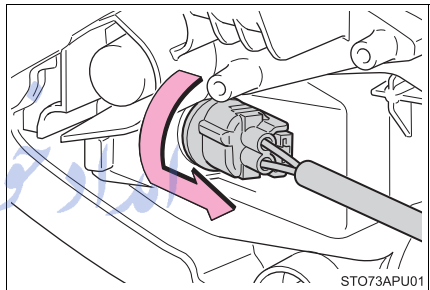

- 2 Remove the light bulb

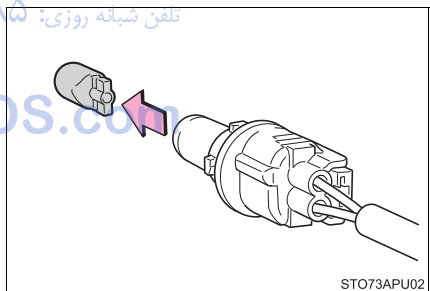

- 3 When installing, reverse the steps listed.

### ■ Front turn signal lights/parking lights

- 1 Turn the bulb base counter-clockwise.

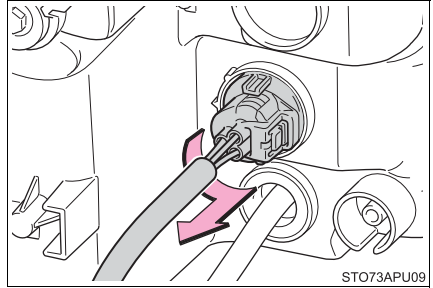

- 2 Remove the light bulb.

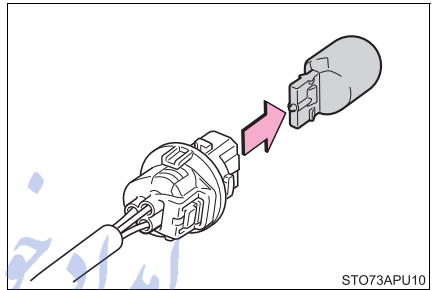

- 3 When installing, reverse the steps listed.

تلفن شبانه روزی: ۰۲۱-۸۸۶۲۰۸۵

FarmaSOS.com

## ■ Stop/tail and rear side marker lights, and rear turn signal lights

- 1 Open the back door and remove the cover.

To prevent damaging the vehicle, wrap the screwdriver with a tape.

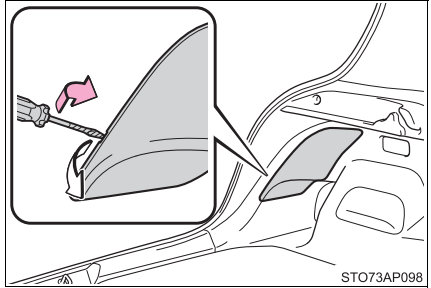

- 2 Turn the bulb base counter-clockwise.

- 1 Stop/tail and rear side marker lights
- 2 Rear turn signal light

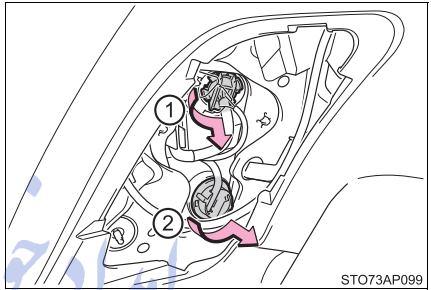

- 3 Remove the light bulb.

- 1 Stop/tail and rear side marker lights
- 2 Rear turn signal light

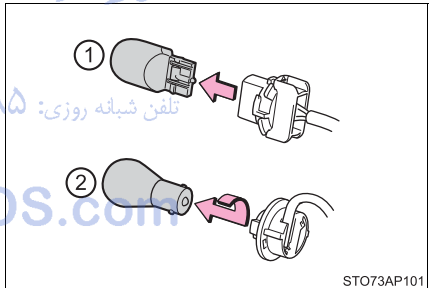

- 4 Install the new bulb.

- 1 Stop/tail and rear side marker lights
- 2 Rear turn signal light

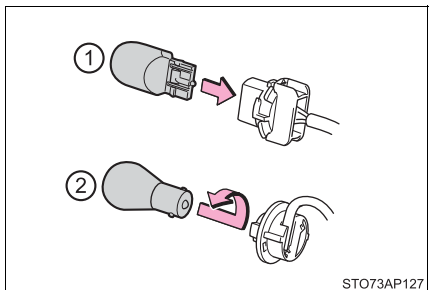

- 5 Turn and secure the bulb base.
- ① Stop/tail and rear side marker lights
  - ② Rear turn signal light

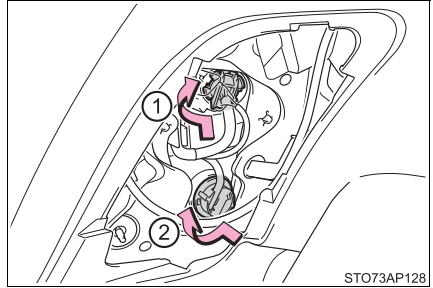

- 6 Install the cover.

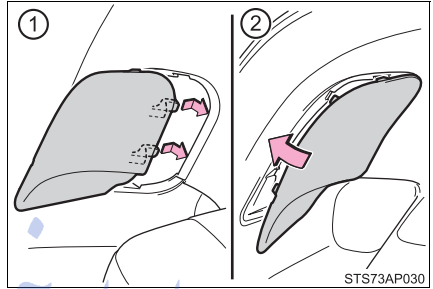

### ■ License plate light

- 1 Remove the cover.

Insert a properly sized screwdriver into the hole of the cover, and pry off the cover as shown in the illustration.

To prevent damaging the vehicle, wrap the screwdriver with a tape.

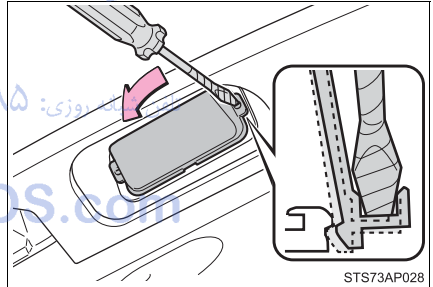

- 2 Remove the light bulb.

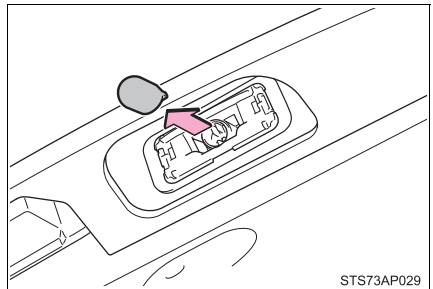



- 3 Install the new bulb.

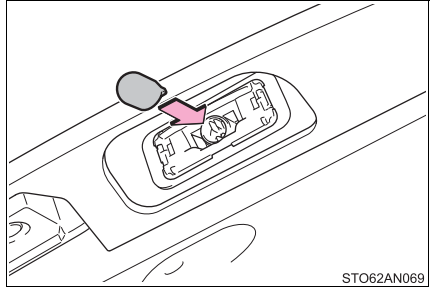

- 4 Install the cover.

Insert a properly sized screwdriver into one of the holes, push the screwdriver until clicking sound is heard. Repeat for the other hole.

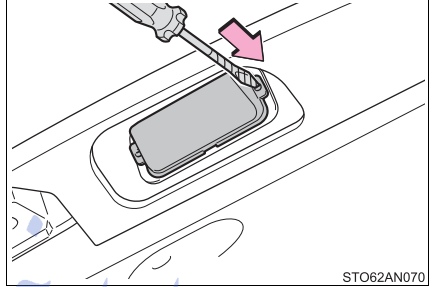

- 5 Make sure that the cover is secured by pressing on the entire cover.

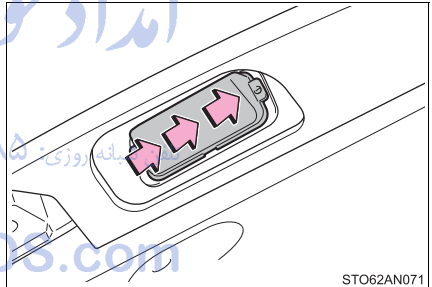

### ■ Back-up light

- 1 Turn the bulb base counter-clockwise.

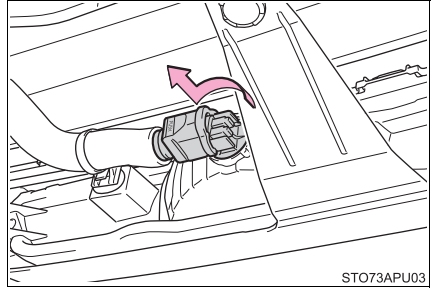

- 2 Remove the light bulb

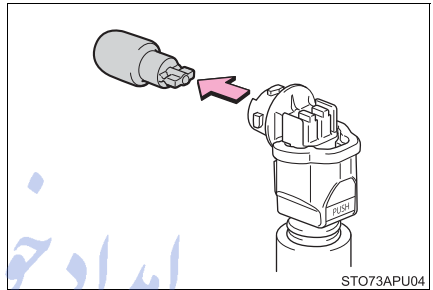

- 3 When installing, reverse the steps listed.

### ■ Lights other than the above

If the high mounted stoplight has burnt out, have it replaced by your Toyota dealer.

### ■ When installing the rubber cover of the headlight

Ensure the rubber cover is securely attached.

- ① Fit the rubber cover outer circumference in firmly.
- ② Fit the rubber cover around the light bulb in until the light bulb plug can be seen.

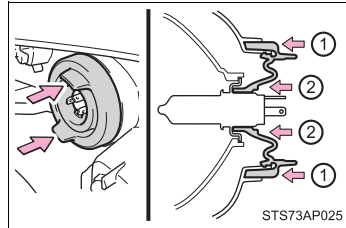

### ■ LED Lights

The high mounted stoplight and daytime running lights (LED type) consists of a number of LEDs. If any of the LEDs burn out, take your vehicle to your Toyota dealer to have the light replaced.

### ■ Condensation build-up on the inside of the lens

Temporary condensation build-up on the inside of the headlight lens does not indicate a malfunction. Contact your Toyota dealer for more information in the following situations:

- Large drops of water have built up on the inside of the lens.
- Water has built up inside the headlight.

### ■ When replacing light bulbs

→P. 246

#### ⚠ WARNING

#### ■ Replacing light bulbs

- Turn off the lights. Do not attempt to replace the bulb immediately after turning off the lights.  
The bulbs become very hot and may cause burns.
- Do not touch the glass portion of the light bulb with bare hands. When it is unavoidable to hold the glass portion, use and hold with a clean dry cloth to avoid getting moisture and oils on the bulb.  
Also, if the bulb is scratched or dropped, it may blow out or crack.
- Fully install light bulbs and any parts used to secure them. Failure to do so may result in heat damage, fire, or water entering the headlight unit. This may damage the headlights or cause condensation to build up on the lens.

#### ■ To prevent damage or fire

Make sure bulbs are fully seated and locked.

# امداد خودرو فارما

تلفن شبانه روزی: ۰۲۱-۸۸۸۶۲۰۸۵

**FarmaSOS.com**

## When trouble arises

# 7

### 7-1. Essential information

Emergency flashers .....	262
If your vehicle has to be stopped in an emergency .....	263

### 7-2. Steps to take in an emergency

If your vehicle needs to be towed .....	265
If you think something is wrong .....	270
Fuel pump shut off system .....	271
If a warning light turns on or a warning buzzer sounds .....	272
If you have a flat tire .....	281
If the engine will not start ..	294
If the shift lever cannot be shifted from P (vehicles with an automatic transmission) .....	296
If the vehicle battery is discharged .....	297
If your vehicle overheats ...	300
If the vehicle becomes stuck .....	303

خودرو فارما

شماره تماس: ۰۲۱-۸۸۶۲۰۸۵

FarmaSOS.com

## Emergency flashers

**The emergency flashers are used to warn other drivers when the vehicle has to be stopped in the road to a breakdown, etc.**

Press the switch.

All the turn signal lights will flash.  
To turn them off, press the switch  
once again.

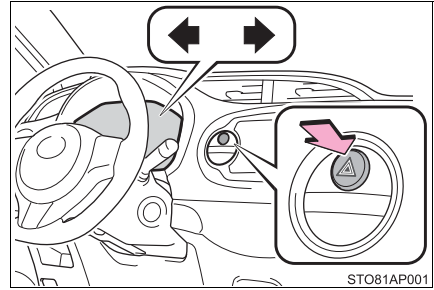

### ■ Emergency flashers

If the emergency flashers are used for a long time while the engine is not running, the battery may discharge.

تلفن شبانه روزی: ۰۲۱-۸۸۶۲۰۸۵

FarmaSOS.com

## If your vehicle has to be stopped in an emergency

**Only in an emergency, such as if it becomes impossible to stop the vehicle in the normal way, stop the vehicle using the following procedure:**

- 1 Steadily step on the brake pedal with both feet and firmly depress it.  
Do not pump the brake pedal repeatedly as this will increase the effort required to slow the vehicle.
- 2 Shift the shift lever to N.
  - ▶ If the shift lever is shifted to N
- 3 After slowing down, stop the vehicle in a safe place by the road.
- 4 Stop the engine.
  - ▶ If the shift lever cannot be shifted to N
- 3 Keep depressing the brake pedal with both feet to reduce vehicle speed as much as possible.
- 4 Stop the engine by turning the engine switch to the “ACC” position.

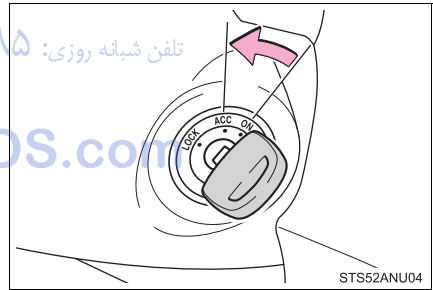

- 5 Stop the vehicle in a safe place by the road.

**WARNING****■ If the engine has to be turned off while driving**

- Power assist for the brakes and steering wheel will be lost, making the brake pedal harder to depress and the steering wheel heavier to turn. Decelerate as much as possible before turning off the engine.
- Never attempt to remove the key, as doing so will lock the steering wheel.

امداد خودرو فارما

تلفن شبانه روزی: ۰۲۱-۸۸۸۶۲۰۸۵

[FarmaSOS.com](http://FarmaSOS.com)



## If your vehicle needs to be towed

If towing is necessary, we recommend having your vehicle towed by your Toyota dealer or a commercial towing service, using a lift-type truck or flatbed truck.

Use a safety chain system for all towing, and abide by all state/provincial and local laws.

If towing your vehicle with a wheel-lift type truck from the front, the vehicle's rear wheels and axles must be in good conditions.

(→P. 265, 269)

If they are damaged, use a towing dolly or flatbed truck.

### Situations needs to contact dealers before towing

The following may indicate a problem with your transmission. Contact your Toyota dealer before towing.

- The engine is running but the vehicle will not move.
- The vehicle makes an abnormal sound.

### Towing with a sling-type truck

Do not tow with a sling-type truck to prevent body damage.

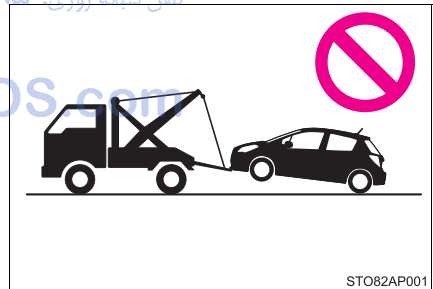

ST082AP001

## Towing with a wheel-lift type truck

► From the front

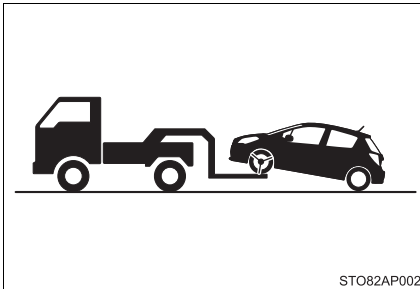

Release the parking brake.

► From the rear

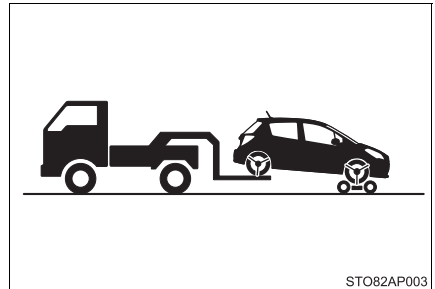

Use a towing dolly under the front wheels.

## Using a flatbed truck

If your Toyota is transported by a flatbed truck, it should be tied down at the locations shown in the illustration.

After transporting, return the covers that were attached to the rear side.

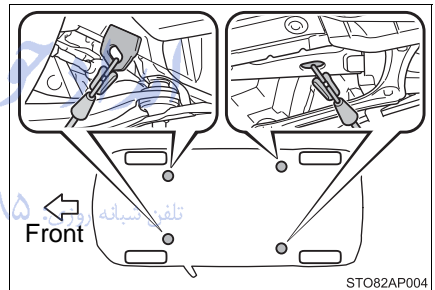

If you use chains or cables to tie down your vehicle, the angles shaded in black must be 45°.

Do not overly tighten the tie downs or the vehicle may be damaged.

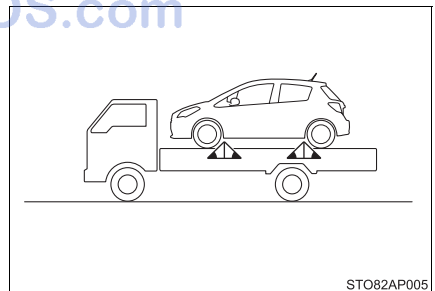

## Emergency towing

If a tow truck is not available in an emergency, your vehicle may be temporarily towed using a cable or chain secured to the emergency towing eyelet. This should only be attempted on hard surfaced roads for 50 miles (80 km) at under 18 mph (30 km/h).

A driver must be in the vehicle to steer and operate the brakes. The vehicle's wheels, drive train, axles, steering and brakes must be in good condition.

## Emergency towing procedure

- 1 Take out the towing eyelet. (→P. 282)
- 2 Remove the eyelet cover by turning.

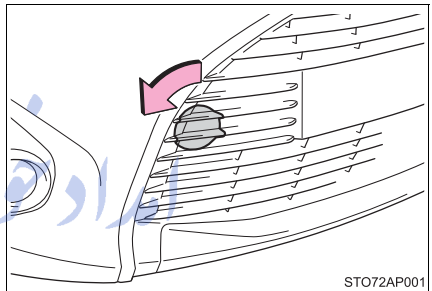

- 3 Insert the towing eyelet into the hole and tighten partially by hand.

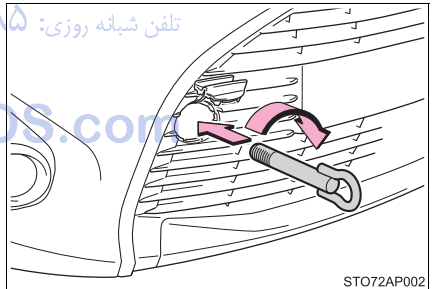

- 4 Tighten down the towing eyelet securely using a wheel nut wrench or hard metal bar.

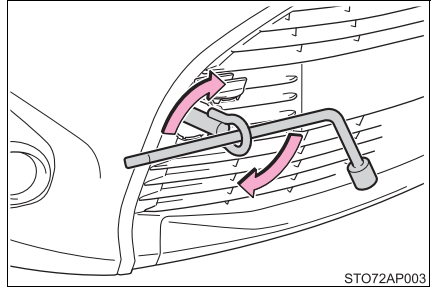

ST072AP003

- 5 Securely attach a cable or chain to the towing eyelet.

Take care not to damage the vehicle body.

- 6 Enter the vehicle being towed and start the engine.

If the engine does not start, turn the engine switch to the "ON" position.

- 7 Shift the shift lever to N and release the parking brake.

When the shift lever cannot be shifted (automatic transmission):  
→P. 296

#### ■ While towing

If the engine is not running, the power assist for the brakes and steering will not function, making steering and braking more difficult.

#### ■ Wheel nut wrench

Wheel nut wrench is installed in the luggage. (→P. 282)

## ⚠ WARNING

Observe the following precautions.  
Failure to do so may result in death or serious injury.

### ■ When towing the vehicle

Be sure to transport the vehicle with the front wheels raised or with all four wheels raised off the ground. If the vehicle is towed with the front wheels contacting the ground, the drivetrain and related parts may be damaged.

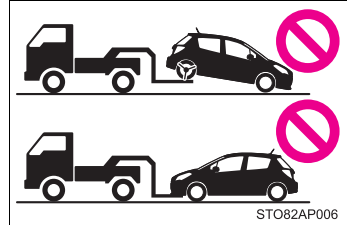

### ■ While towing

- When towing using a rope, avoid sudden starts, etc. which place excessive stress on the towing hook and rope.  
The towing hook or rope may become damaged, broken debris may hit people and cause serious damage.
- Do not turn the engine switch to the “LOCK” position.  
There is a possibility that the steering wheel is locked and can not be operated.

### ■ Installing towing eyelets to the vehicle

Make sure that towing eyelets are installed securely.  
If not securely installed, towing eyelets may come loose during towing.

## ⚠ NOTICE

FarmaSOS.com

### ■ To prevent damage to the vehicle when towing using a wheel-lift type truck

When raising the vehicle, ensure adequate ground clearance for towing at the opposite end of the raised vehicle. Without adequate clearance, the vehicle could be damaged while being towed.

### ■ To prevent body damage when towing with a sling-type truck

Do not tow with a sling-type truck, either from the front or rear.

## If you think something is wrong

**If you notice any of the following symptoms, your vehicle probably needs adjustment or repair. Contact your Toyota dealer as soon as possible.**

### Visible symptoms

- Fluid leaks under the vehicle  
(Water dripping from the air conditioning after use is normal)
- Flat-looking tires or uneven tire wear
- High engine coolant temperature warning light flashes or comes on
- Low engine coolant temperature indicator comes on or does not come on continuously

### Audible symptoms

- Changes in exhaust sound
- Excessive tire squeal when cornering
- Strange noises related to the suspension system
- Pinging or other noises related to the engine

### Operational symptoms

- Engine misfire, stumbling or running roughly
- Appreciable loss of power
- Vehicle pulls heavily to one side when braking
- Vehicle pulls heavily to one side when driving on a level road
- Loss of brake effectiveness, spongy feeling, pedal almost touches the floor

## Fuel pump shut off system

**To minimize the risk of fuel leakage when the engine stalls or when an airbag inflates upon collision, the fuel pump shut off system stops the supply of fuel to the engine.**

Follow the procedure below to restart the engine after the system is activated.

- 1 Turn the engine switch to the “ACC” or “LOCK” position.
- 2 Restart the engine.



### NOTICE

#### ■ Before starting the engine

Inspect the ground under the vehicle.

If you find that fuel has leaked onto the ground, the fuel system has been damaged and is in need of repair. Do not restart the engine.





تلفن شبانه روزی: ۰۲۱-۸۸۶۲۰۸۵

FarmaSOS.com







## If a warning light turns on or a warning buzzer sounds





Calmly perform the following actions if any of the warning lights comes on or flashes. If a light comes on or flashes, but then goes off, this does not necessarily indicate a malfunction in the system. However, if this continues to occur, have the vehicle inspected by your Toyota dealer.



### Warning light and warning buzzer list

Warning light	Warning light/Details/Actions
 <p>(Except Canada)</p>  <p>(Canada)</p>	<p><b>Brake system warning light (warning buzzer)*1</b></p> <ul style="list-style-type: none"> <li>• Low brake fluid</li> <li>• Malfunction in the brake system</li> </ul> <p>This light also comes on when the parking brake is not released. If the light turns off after the parking brake is fully released, the system is operating normally.</p> <p>→ <b>Immediately stop the vehicle in a safe place and contact your Toyota dealer. Continuing to drive the vehicle may be dangerous.</b></p>
	<p><b>Charging system warning light</b></p> <p>Indicates a malfunction in the vehicle's charging system.</p> <p>→ <b>Immediately stop the vehicle in a safe place and contact your Toyota dealer.</b></p>
	<p><b>Low engine oil pressure warning light</b></p> <p>Indicates that the engine oil pressure is too low.</p> <p>→ <b>Immediately stop the vehicle in a safe place and contact your Toyota dealer.</b></p>
 <p>(Red warning light flashes or comes on)</p>	<p><b>High engine coolant temperature warning light (flashes or comes on)</b></p> <p>Indicates that the engine is overheating.</p> <p>As the coolant temperature rises, it changes from flashing to steady on.</p> <p>→ <b>P. 300</b></p>



Warning light	Warning light/Details/Actions
 <p>(Except Canada)</p>  <p>(Canada)</p>	<p><b>Malfunction indicator lamp</b></p> <p>Indicates a malfunction in:</p> <ul style="list-style-type: none"> <li>• The electronic engine control system;</li> <li>• The electronic throttle control system;</li> <li>• The electronic automatic transmission control system.</li> </ul> <p>→ <b>Have the vehicle inspected by your Toyota dealer immediately.</b></p>
	<p><b>SRS warning light</b></p> <p>Indicates a malfunction in:</p> <ul style="list-style-type: none"> <li>• The SRS airbag system;</li> <li>• The front passenger occupant classification system; or</li> <li>• The seat belt pretensioner system.</li> </ul> <p>→ <b>Have the vehicle inspected by your Toyota dealer immediately.</b></p>
<p><b>ABS</b></p> <p>(Except Canada)</p>  <p>(Canada)</p>	<p><b>ABS warning light</b></p> <p>Indicates a malfunction in:</p> <ul style="list-style-type: none"> <li>• The ABS; or</li> <li>• The brake assist system.</li> </ul> <p>→ <b>Have the vehicle inspected by your Toyota dealer immediately.</b></p>
	<p><b>Electric power steering system warning light (warning buzzer)</b></p> <p>Indicates a malfunction in the EPS (Electric Power Steering) system.</p> <p>→ <b>Have the vehicle inspected by your Toyota dealer immediately.</b></p>
	<p><b>Slip indicator light</b></p> <p>Indicates a malfunction in:</p> <ul style="list-style-type: none"> <li>• The VSC system; or</li> <li>• The TRAC system.</li> </ul> <p>→ <b>Have the vehicle inspected by your Toyota dealer immediately.</b></p>

Warning light	Warning light/Details/Actions
 <p>(Yellow)</p>	<p><b>Cruise control indicator light (if equipped)</b>            Indicates a malfunction in the cruise control system.            → <b>Have the vehicle inspected by your Toyota dealer immediately.</b></p>
	<p><b>Open door warning light (warning buzzer)*2</b>            Indicates that one or more of the doors is not fully closed.            → <b>Check that all the side doors and back door are closed.</b></p>
	<p><b>Low fuel level warning light</b>            Indicates that remaining fuel is about 1.7 gal. (6.3 L, 1.4 Imp.gal.) or less.            → <b>Refuel the vehicle.</b></p>
	<p><b>Driver's and front passenger's seat belt reminder light (warning buzzer)*3</b>            Warns the driver and front passenger to fasten their seat belts            → <b>Fasten the seat belt.</b>  <b>If the passenger's seat is occupied, the front passenger's seat belt also needs to be fastened to make the warning light (warning buzzer) turn off.</b></p>
	<p><b>Tire pressure warning light (except Canada)</b>            When the light comes on; Low tire inflation pressure such as  <ul style="list-style-type: none"> <li>• Natural causes (→P. 277)</li> <li>• Flat tire (→P. 281)</li> </ul>           → <b>Adjust the tire inflation pressure to the specified level.</b>  <b>The light will turn off after a few minutes. In case the light does not turn off even if the tire inflation pressure is adjusted, have the system checked by your Toyota dealer.</b>            When the light comes on after blinking for 1 minute:            Malfunction in the tire pressure warning system.            (→P. 278)            → <b>Have the system checked by your Toyota dealer.</b></p>

Warning light	Warning light/Details/Actions
	<p><b>Low windshield washer fluid warning light (if equipped)</b> Indicate that the washer fluid level is low. → <b>Add washer fluid (→P. 221)</b></p>
	<p><b>Maintenance required reminder light (except Canada)</b> Indicates that maintenance is required according to the driven distance on the maintenance schedule.*4 Illuminates for about 3 seconds and then flashes for about 15 seconds approximately 4500 miles (7200 km) after the maintenance data has been reset. → <b>If necessary, perform maintenance.</b> Comes on and remains on if the distance driven exceeds 5000 miles (8000 km) after the maintenance data has been reset. (The indicator will not work properly unless the maintenance data has been reset.) → <b>Perform the necessary maintenance. Please reset the maintenance data after the maintenance is performed. (→P. 201)</b></p>

- \*1: Parking brake engaged warning buzzer:  
The buzzer sounds to indicate that the parking brake is still engaged (with the vehicle having reached a speed of 3 mph [5 km/h]).
- \*2: Open door warning buzzer:  
A buzzer will sound if the vehicle reaches a speed of 3 mph (5 km/h) or more with any door open.
- \*3: Driver's and front passenger's seat belt buzzer:  
The driver's and passenger's seat belt buzzer sounds to alert the driver and front passenger that his or her seat belt is not fastened. Once the engine switch is turned to the "ON" or "START" position, the buzzer sounds for 6 seconds. The buzzer sounds once if the driver's or front passenger's seat belt is unfastened when the vehicle reaches a speed of 12 mph (20 km/h). Then, if the seat belt is still unfastened after 30 seconds elapse, the buzzer will sound intermittently for approximately 10 seconds, followed by a different tone for approximately 20 more seconds.
- \*4: Refer to the separate "Scheduled Maintenance Guide" or "Owner's Manual Supplement" for the maintenance interval applicable to your vehicle.

### ■ SRS warning light

This warning light system monitors the airbag sensor assembly, front impact sensors, side impact sensors, driver's seat belt buckle switch, front passenger occupant classification system (ECU and sensors), "AIR BAG ON" indicator light, "AIR BAG OFF" indicator light, front passenger's seat belt buckle switch, seat belt pretensioner assemblies, airbags, interconnecting wiring and power sources. (→P. 34)

### ■ Front passenger detection sensor, passenger seat belt reminder and warning buzzer

- If luggage is placed on the front passenger seat, the front passenger detection sensor may cause the warning light to flash and the warning buzzer to sound even if a passenger is not sitting in the seat.
- If a cushion is placed on the seat, the sensor may not detect a passenger, and the warning light may not operate properly.

### ■ Electric power steering system warning light (warning buzzer)

When the battery charge becomes insufficient or the voltage temporarily drops, the electric power steering system warning light may come on and the warning buzzer may sound.

### ■ If the malfunction indicator lamp comes on while driving

First check the following:

- Is the fuel tank empty?  
If it is, fill the fuel tank immediately.
- Is the fuel tank cap loose?  
If it is, tighten it securely.

The malfunction indicator lamp will go off after several driving trips.

If the malfunction indicator lamp does not go off even after several trips, contact your Toyota dealer as soon as possible.

### ■ When the tire pressure warning light comes on (vehicles with a tire pressure warning system)

Check the tire inflation pressure and adjust to the appropriate level. Pushing the tire pressure warning reset switch will not turn off the tire pressure warning light.

■ **The tire pressure warning light may come on due to natural causes (vehicles with a tire pressure warning system)**

The tire pressure warning light may come on due to natural causes such as natural air leaks and tire inflation pressure changes caused by temperature. In this case, adjusting the tire inflation pressure will turn off the warning light (after a few minutes).

■ **When a tire is replaced with a spare tire (vehicles with a tire pressure warning system)**

The compact spare tire is not equipped with a tire pressure warning valve and transmitter. If a tire goes flat, the tire pressure warning light will not turn off even though the flat tire has been replaced with the spare tire. Replace the spare tire with the repaired tire and adjust the tire inflation pressure. The tire pressure warning light will go off after a few minutes.

■ **If the tire pressure warning system is not functioning (vehicles with a tire pressure warning system)**

The system will be disabled in the following conditions:

(When the condition becomes normal, the system will work properly.)

- If tires not equipped with tire pressure warning valves and transmitters are used
- If the ID code on the tire pressure warning valves and transmitters are not registered in the tire pressure warning computer
- If the tire inflation pressure is 73 psi (500 kPa, 5.1 kgf/cm<sup>2</sup> or bar) or higher

The tire pressure warning system may be disabled in the following conditions:

(When the condition becomes normal, the system will work properly.)

- If electronic devices or facilities using similar radio wave frequencies are nearby
- If a radio set at a similar frequency is in use in the vehicle
- If a window tint that affects the radio wave signals is installed
- If there is a lot of snow or ice on the vehicle, particularly around the wheels or wheel housings
- If non-genuine Toyota wheels are used (Even if you use Toyota wheels, the tire pressure warning system may not work properly with some types of tires.)
- If tire chains are used

■ **If the tire pressure warning light frequently comes on after blinking for 1 minute (vehicles with a tire pressure warning system)**

If the tire pressure warning light frequently comes on after blinking for 1 minute when the engine switch is turned to the "ON" position, have it checked by your Toyota dealer.

■ **Customization that can be configured at Toyota dealer**

The vehicle speed linked seat belt reminder buzzer can be disabled. (Customizable features →P. 333) However, Toyota recommends that the seat belt reminder buzzer be operational to alert the driver and front passenger when seat belts are not fastened.



**WARNING**

■ **When the electric power steering system warning light comes on**

The steering wheel may become extremely heavy.

If the steering wheel becomes heavier than usual when operating, hold firmly and operate using more force than usual.

■ **If the tire pressure warning light comes on (vehicles with a tire pressure warning system)**

Be sure to observe the following precautions. Failure to do so could cause a loss of vehicle control and result in death or serious injury.

- Stop your vehicle in a safe place as soon as possible. Adjust the tire inflation pressure immediately.
- If the tire pressure warning light comes on even after tire inflation pressure adjustment, it is probable that you have a flat tire. Check the tires. If a tire is flat, change it with the spare tire and have the flat tire repaired by the nearest Toyota dealer.
- Avoid abrupt maneuvering and braking. If the vehicle tires deteriorate, you could lose control of the steering wheel or the brakes.

■ **If a blowout or sudden air leakage should occur (vehicles with a tire pressure warning system)**

The tire pressure warning system may not activate immediately.

 **WARNING****■ Maintenance of the tire (vehicles with a tire pressure warning system)**

Each tire, including the spare (if provided), should be checked monthly when cold and inflated to the inflation pressure recommended by the vehicle manufacturer on the vehicle placard or tire inflation pressure label (tire and load information label). (If your vehicle has tires of a different size than the size indicated on the vehicle placard or tire inflation pressure label [tire and load information label], you should determine the proper tire inflation pressure for those tires.)

As an added safety feature, your vehicle has been equipped with a tire pressure monitoring system (TPMS-tire pressure warning system) that illuminates a low tire pressure telltale (tire pressure warning light) when one or more of your tires is significantly under-inflated. Accordingly, when the low tire pressure telltale (tire pressure warning light) illuminates, you should stop and check your tires as soon as possible, and inflate them to the proper pressure. Driving on a significantly under-inflated tire causes the tire to overheat and can lead to tire failure. Under-inflation also reduces fuel efficiency and tire tread life, and may affect the vehicle's handling and stopping ability.

Please note that the TPMS (tire pressure warning system) is not a substitute for proper tire maintenance, and it is the driver's responsibility to maintain correct tire pressure, even if under-inflation has not reached the level to trigger illumination of the TPMS low tire pressure telltale (tire pressure warning light).

FarmaSOS.com

 **WARNING**

Your vehicle has also been equipped with a TPMS (tire pressure warning system) malfunction indicator to indicate when the system is not operating properly. The TPMS (tire pressure warning system) malfunction indicator is combined with the low tire pressure telltale (tire pressure warning light). When the system detects a malfunction, the telltale will flash for approximately one minute and then remain continuously illuminated. This sequence will continue upon subsequent vehicle start-ups as long as the malfunction exists. When the malfunction indicator is illuminated, the system may not be able to detect or signal low tire pressure as intended.

TPMS (tire pressure warning system) malfunctions may occur for a variety of reasons, including the installation of replacement or alternate tires or wheels on the vehicle that prevent the TPMS (tire pressure warning system) from functioning properly. Always check the TPMS (tire pressure warning system) malfunction telltale after replacing one or more tires or wheels on your vehicle to ensure that the replacement or alternate tires and wheels allow the TPMS (tire pressure warning system) to continue to function properly.

 **NOTICE**

■ **To ensure the tire pressure warning system operates properly (vehicles with a tire pressure warning system)**

Do not install tires with different specifications or makers, as the tire pressure warning system may not operate properly.



## If you have a flat tire

**Your vehicle is equipped with a spare tire. The flat tire can be replaced with the spare tire.**

**For details about tires: →P. 223**

### WARNING

#### ■ If you have a flat tire

Do not continue driving with a flat tire.

Driving even a short distance with a flat tire can damage the tire and the wheel beyond repair, which could result in an accident.

### Before jacking up the vehicle

- Stop the vehicle on a hard, flat surface.
- Set the parking brake.
- Shift the shift lever to P (automatic transmission) or R (manual transmission).
- Stop the engine.
- Turn on the emergency flashers. (→P. 262) تلفن شد ۰۲۱ ۸۸۴۲۸۸

FarmaSOS.com

## Location of the spare tire, jack and tool bag

### ■ Location

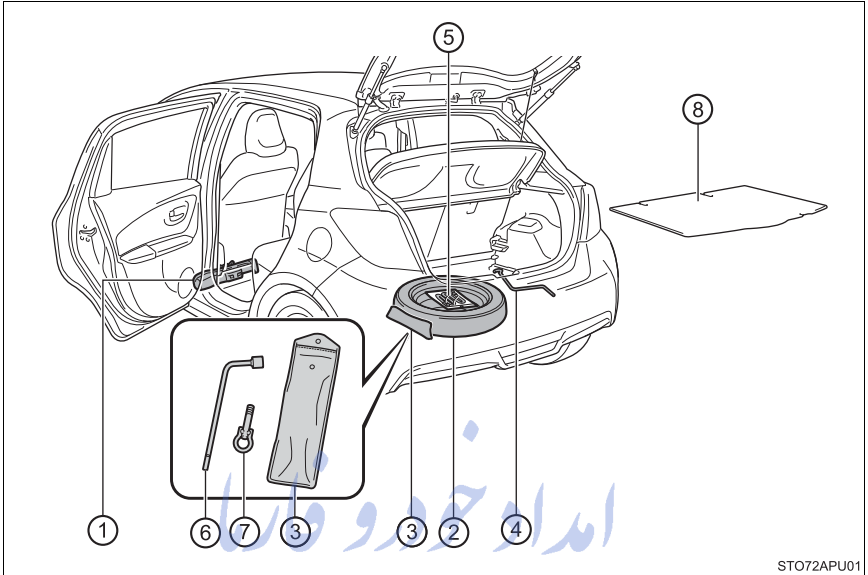

STO7ZAPU01

- |               |                       |
|---------------|-----------------------|
| ① Jack        | ⑤ Tie-down belt       |
| ② Spare tire  | ⑥ Wheel nut wrench    |
| ③ Tool bag    | ⑦ Towing eyelet       |
| ④ Jack handle | ⑧ Luggage floor cover |

 **WARNING****■ Using the tire jack**

Observe the following precautions.

Improper use of the tire jack may cause the vehicle to suddenly fall off the jack, leading to death or serious injury.

- Do not use the tire jack for any purpose other than replacing tires or installing and removing tire chains.
- Only use the tire jack that comes with this vehicle for replacing a flat tire.  
Do not use it on other vehicles, and do not use other tire jacks for replacing tires on this vehicle.
- Put the jack properly in its jack point.
- Do not put any part of your body under the vehicle while it is supported by the jack.
- Do not start the engine or drive the vehicle while the vehicle is supported by the jack.
- Do not raise the vehicle while someone is inside.
- When raising the vehicle, do not put an object on or under the jack.
- Do not raise the vehicle to a height greater than that required to replace the tire.
- Use a jack stand if it is necessary to get under the vehicle.
- When lowering the vehicle, make sure that there is no-one near the vehicle. If there are people nearby, warn them vocally before lowering.

### Taking out the jack

- 1 Move the driver's seat to the front most position and remove the cover.

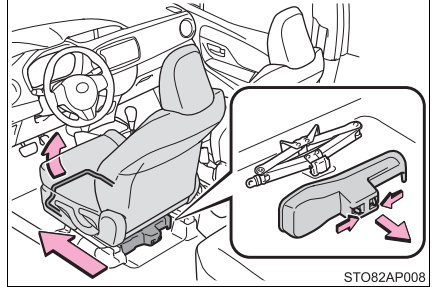

- 2 Take out the jack.
  - ① For tightening
  - ② For loosening

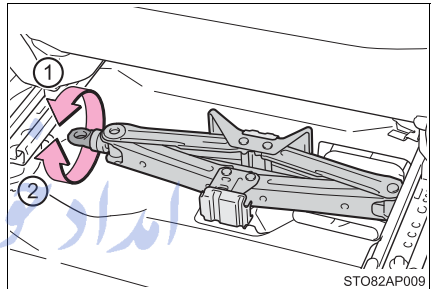

### Taking out the spare tire

- 1 Lift the deck board and pull it toward you to remove it. (→P. 189)
- 2 Remove the luggage floor cover.

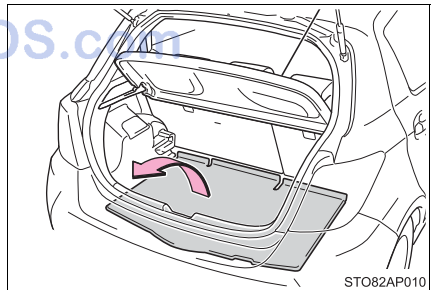

- 3 Loosen the center fastener that secures the spare tire.

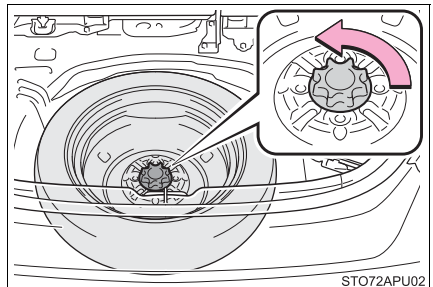

## Replacing a flat tire

- 1 Chock the tires.

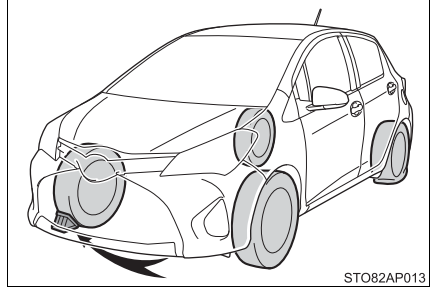

Flat tire		Wheel chock positions
Front	Left-hand side	Behind the rear right-hand side tire
	Right-hand side	Behind the rear left-hand side tire
Rear	Left-hand side	In front of the front right-hand side tire
	Right-hand side	In front of the front left-hand side tire

- 2 For vehicles with steel wheels, remove the wheel ornament using the wrench.

To protect the wheel ornament, place a rag between the wrench and the wheel ornament.

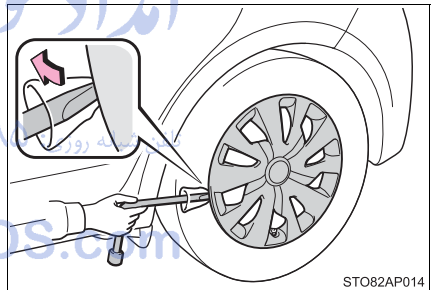

- 3 Slightly loosen the wheel nuts (one turn).

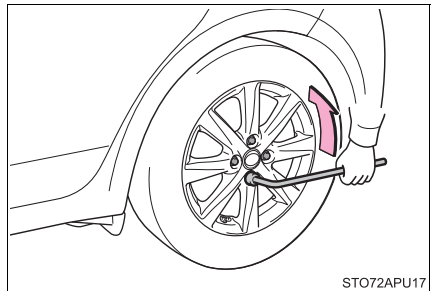

- 4 Turn the tire jack portion (A) by hand until the notch of the jack is in contact with the jack point.

The jack point guides are located under the rocker panel. They indicate the jack point positions.

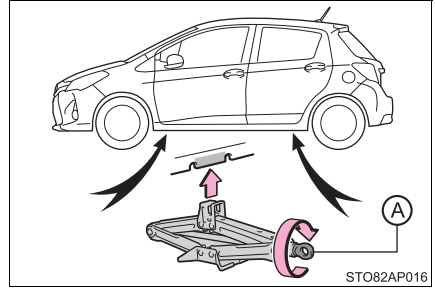

- 5 Raise the vehicle until the tire is slightly raised off the ground.

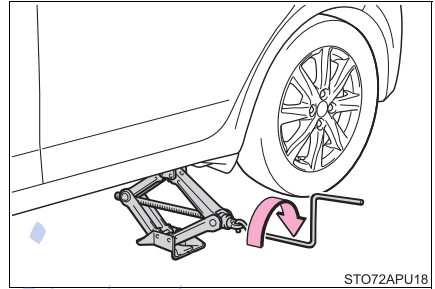

- 6 Remove all the wheel nuts and the tire.

When resting the tire on the ground, place the tire so that the wheel design faces up to avoid scratching the wheel surface.

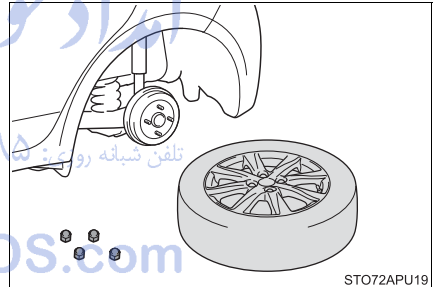

 **WARNING**

### ■ Replacing a flat tire

- Observe the following precautions.

Failure to do so may result in serious injury:

- Do not try to remove the wheel ornament by hand. Take due care in handling the ornament to avoid unexpected personal injury.
- Do not touch the disc wheels or the area around the brakes immediately after the vehicle has been driven.

After the vehicle has been driven the disc wheels and the area around the brakes will be extremely hot. Touching these areas with hands, feet or other body parts while changing a tire, etc., may result in burns.

- Failure to follow these precautions could cause the wheel nuts to loosen and the tire to fall off, resulting in death or serious injury.
  - Have the wheel nuts tightened with a torque wrench to 76 ft·lbf (103 N·m, 10.5 kgf·m) as soon as possible after changing wheels.
  - When installing a tire, only use wheel nuts that have been specifically designed for that wheel.
  - If there are any cracks or deformations in the bolt screws, nut threads or bolt holes of the wheel, have the vehicle inspected by your Toyota dealer.
  - When installing the wheel nuts, be sure to install them with the tapered ends facing inward. (→P. 236)

تلف: شماره روت: ۰۲۱-۸۸۶۲۰۸۵

FarmaSOS.com

## Installing the spare tire

- 1 Remove any dirt or foreign matter from the wheel contact surface.

If foreign matter is on the wheel contact surface, the wheel nuts may loosen while the vehicle is in motion, causing the tire to come off.

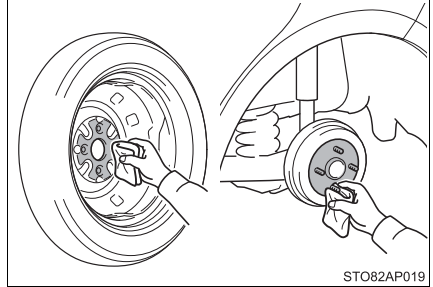

- 2 Install the tire and loosely tighten each wheel nut by hand by approximately the same amount.

When replacing a steel wheel with a compact spare tire, tighten the wheel nuts until the tapered portion comes into loose contact with the disc wheel seat.

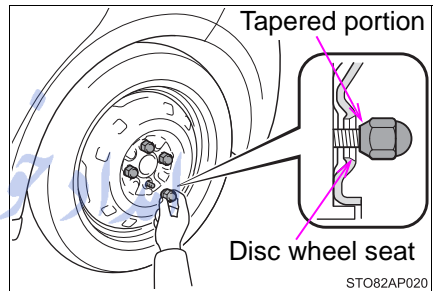

When replacing an aluminum wheel with a compact spare tire, tighten the wheel nuts until the tapered portion comes into loose contact with the disc wheel seat.

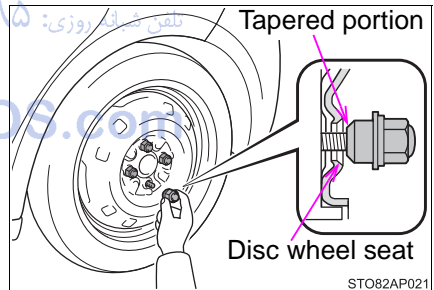

- 3 Lower the vehicle.

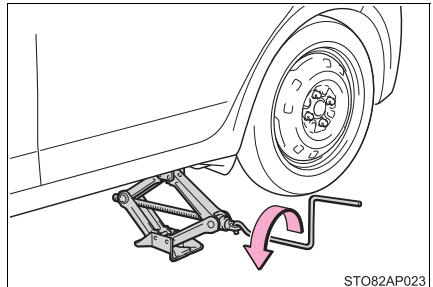



- 4 Firmly tighten each wheel nut two or three times in the order shown in the illustration.

**Tightening torque:**

76 ft·lbf (103 N·m, 10.5 kgf·m)

Do not use other tools or any additional leverage other than your hands, such as a hammer, pipe or your foot.

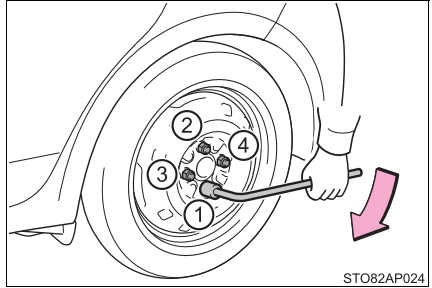

**Stowing the flat tire, jack and all tools**

- 1 Stow the jack and all tools.  
2 Return the deck board.

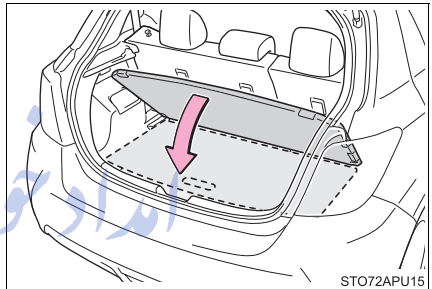

- 3 Vehicles with an aluminum wheels, remove the center wheel ornament by pushing from the reverse side.

Be careful not to lose the wheel ornament.

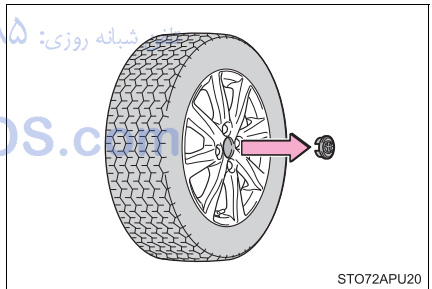

- 4 Hook each belt end to the corresponding anchor brackets. Put the center portion of the belt onto the rear center head restraint.

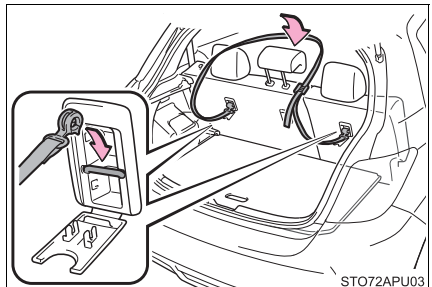

- 5 Lay the flat tire on the luggage floor so that the outer side of the tire wheel faces toward the rear of the vehicle. Detach the rear center head restraint from the seat and release the belt.

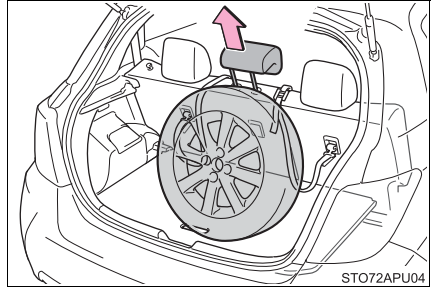

- 6 Pass the belt through the center hole of the flat tire wheel.

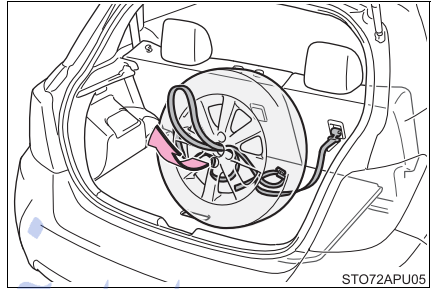

- 7 Put the center portion of the belt onto the rear center head restraint position and then return the rear center head restraint.

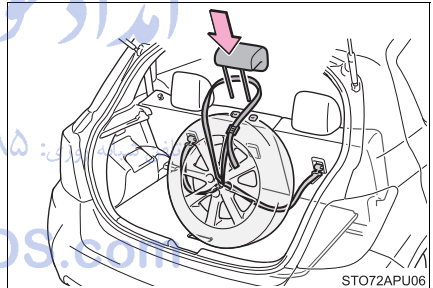

- 8 Hold the buckle and pull the belt to secure the tire.

After stowing the flat tire, check that the tire and belt are secured.

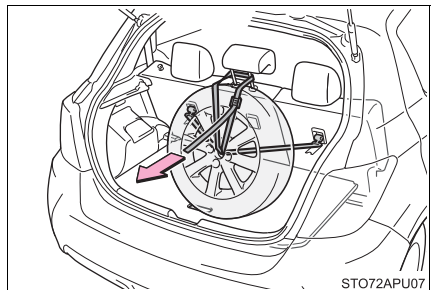

### ■ The compact spare tire

- The compact spare tire is identified by the label “TEMPORARY USE ONLY” on the tire sidewall.  
Use the compact spare tire temporarily, and only in an emergency.
- Make sure to check the tire inflation pressure of the compact spare tire. (→P. 315)

### ■ After completing the tire change (vehicles with a tire pressure warning system)

The tire pressure warning system must be reset. (→P. 224)

### ■ When using the compact spare tire (vehicles with a tire pressure warning system)

As the compact spare tire is not equipped with a tire pressure warning valve and transmitter, low inflation pressure of the spare tire will not be indicated by the tire pressure warning system. Also, if you replace the compact spare tire after the tire pressure warning light comes on, the light remains on.

### ■ If you have a flat front tire on a road covered with snow or ice

Install the compact spare tire on one of the rear wheels of the vehicle. Perform the following steps and fit tire chains to the front tires:

- 1 Replace a rear tire with the compact spare tire.
- 2 Replace the flat front tire with the tire removed from the rear of the vehicle.
- 3 Fit tire chains to the front tires.

FarmaSOS.com

**WARNING****■ When using the compact spare tire**

- Remember that the compact spare tire provided is specifically designed for use with your vehicle. Do not use your compact spare tire on another vehicle.
- Do not use more than one compact spare tire simultaneously.
- Replace the compact spare tire with a standard tire as soon as possible.
- Avoid sudden acceleration, abrupt steering, sudden braking and shifting operations that cause sudden engine braking.

**■ When storing the compact spare tire**

Be careful not to catch fingers or other body parts between the compact spare tire and the body of the vehicle.

**■ After using the tools and jack**

Before driving, make sure all the tools and jack are securely in place in their storage location to reduce the possibility of personal injury during a collision or sudden braking.

**■ When the compact spare tire is attached**

The vehicle speed may not be correctly detected, and the following systems may not operate correctly:

- ABS
- Brake assist
- VSC
- TRAC
- Cruise control (if equipped)

**■ Speed limit when using the compact spare tire**

Do not drive at speeds in excess of 50 mph (80 km/h) when a compact spare tire is installed on the vehicle.

The compact spare tire is not designed for driving at high speeds. Failure to observe this precaution may lead to an accident causing death or serious injury.

**■ When stowing the flat tire**

- Make sure the rear seats are in their original position.
- Secure it using a tire tie-down belt. Otherwise, the flat tire may fly out in case of the sudden braking or an accident, resulting in death or serious injury.

 NOTICE**■ Do not drive the vehicle with a flat tire**

Do not continue driving with a flat tire.

Driving even a short distance with a flat tire can damage the tire and the wheel beyond repair.

**■ Be careful when driving over bumps with the compact spare tire installed on the vehicle**

The vehicle becomes lower when driving with the compact spare tire compared to when driving with standard tires. Be careful when driving over uneven road surfaces.

**■ Driving with tire chains and the compact spare tire**

Do not fit tire chains to the compact spare tire.

Tire chains may damage the vehicle body and adversely affect driving performance.

**■ When replacing the tires (vehicles with a tire pressure warning system)**

When removing or fitting the wheels, tires or the tire pressure warning valve and transmitter, contact your Toyota dealer as the tire pressure warning valve and transmitter may be damaged if not handled correctly.

**■ To avoid damage to the tire pressure warning valves and transmitters (vehicles with a tire pressure warning system)**

When a tire is repaired with liquid sealants, the tire pressure warning valve and transmitter may not operate properly. If a liquid sealant is used, contact your Toyota dealer or other qualified service shop as soon as possible. Make sure to replace the tire pressure warning valve and transmitter when replacing the tire. (→P. 224)

## If the engine will not start

**If the engine will not start even though correct starting procedures are being followed (→P. 136), consider each of the following points:**

**The engine will not start even though the starter motor operates normally.**

One of the following may be the cause of the problem:

- There may not be sufficient fuel in the vehicle's tank.  
Refuel the vehicle.
- The engine may be flooded.  
Try to restart the engine again following correct starting procedures.  
(→P. 136)
- Vehicles with engine immobilizer system: There may be a malfunction in the engine immobilizer system. (→P. 67)

**The starter motor turns over slowly, the interior lights and headlights are dim, or the horn does not sound or sounds at a low volume.**

One of the following may be the cause of the problem:

- The battery may be discharged. (→P. 297)
- The battery terminal connections may be loose or corroded.

**The starter motor does not turn over, the interior lights and head-lights do not turn on, or the horn does not sound.**

One of the following may be the cause of the problem:

- One or both of the battery terminals may be disconnected.
- The battery may be discharged. (→P. 297)
- There may be a malfunction in the steering lock system (vehicles with a smart entry & start system).

Contact your Toyota dealer if the problem cannot be repaired, or if repair procedures are unknown.

امداد خودرو فارما

تلفن شبانه روزی: ۰۲۱-۸۸۸۶۲۰۸۵

FarmaSOS.com

## If the shift lever cannot be shifted from P (vehicles with an automatic transmission)

If the shift lever cannot be shifted with your foot on the brake pedal, there may be a problem with the shift lock system (a system to prevent accidental operation of the shift lever). Have the vehicle inspected by your Toyota dealer immediately.

The following steps may be used as an emergency measure to ensure that the shift lever can be shifted:

- 1 Set the parking brake.
- 2 Turn the engine switch to the "ACC" position.
- 3 Depress the brake pedal.
- 4 Pry the cover up with a flathead screwdriver or equivalent tool.

To prevent damage to the cover, wrap the tip of the screwdriver with a rag.

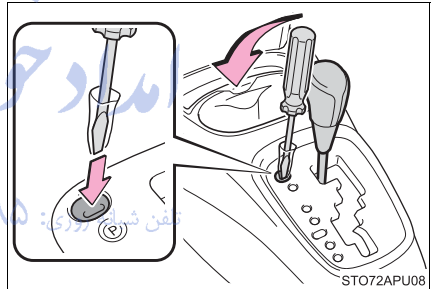

- 5 Press the shift lock override button.

The shift lever can be shifted while the button is pressed.

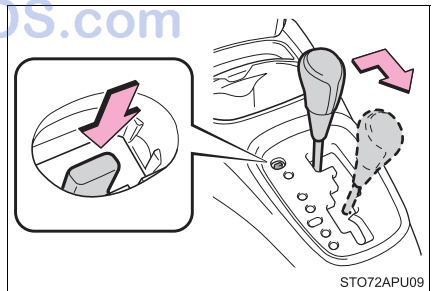



## If the vehicle battery is discharged

The following procedures may be used to start the engine if the vehicle's battery is discharged.

You can also call your Toyota dealer or a qualified repair shop.

If you have a set of jumper (or booster) cables and a second vehicle with a 12-volt battery, you can jump start your vehicle by following the steps below.

- 1 Open the hood. (→P. 209)
- 2 Connect the jumper cables according to the following procedure:

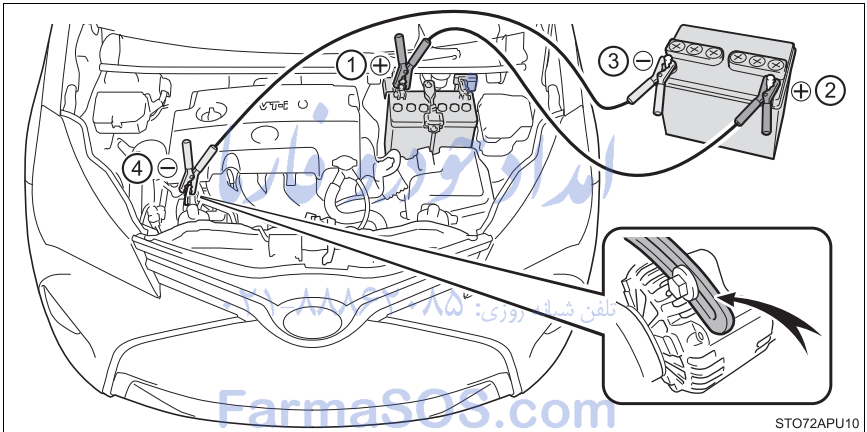

- ① Connect a positive jumper cable clamp to the positive (+) battery terminal on your vehicle.
- ② Connect the clamp on the other end of the positive cable to the positive (+) battery terminal on the second vehicle.
- ③ Connect a negative cable clamp to the negative (-) battery terminal on the second vehicle.
- ④ Connect the clamp at the other end of the negative cable to a solid, stationary, unpainted metallic point away from the battery and any moving parts, as shown in the illustration.

- 3 Start the engine of the second vehicle. Increase the engine speed slightly and maintain at that level for approximately 5 minutes to recharge the battery of your vehicle.
- 4 Maintain the engine speed of the second vehicle and start the engine of your vehicle.
- 5 Once the vehicle's engine has started, remove the jumper cables in the exact reverse order from which they were connected.

Once the engine starts, have the vehicle inspected at your Toyota dealer as soon as possible.

---

■ **Starting the engine when the battery is discharged (vehicles with an automatic transmission)**

The engine cannot be started by push-starting.

■ **To prevent battery discharge**

- Turn off the headlights and the audio system while the engine is not running.
- Turn off any unnecessary electrical components when the vehicle is running at a low speed for an extended period, such as in heavy traffic.

■ **Charging the battery**

The electricity stored in the battery will discharge gradually even when the vehicle is not in use, due to natural discharge and the draining effects of certain electrical appliances. If the vehicle is left for a long time, the battery may discharge, and the engine may be unable to start. (The battery recharges automatically during driving.)

**WARNING****■ Avoiding battery fires or explosions**

Observe the following precautions to prevent accidentally igniting the flammable gas that may be emitted from the battery:

- Make sure each jumper cable is connected to the correct terminal and that it is not unintentionally in contact with anything other than the intended terminal.
- Do not allow the + and - clamps of the jumper cables to come into contact with each other.
- Do not smoke, use matches, cigarette lighters or allow open flame near the battery.

**■ Battery precautions**

The battery contains poisonous and corrosive acidic electrolyte, while related parts contain lead and lead compounds. Observe the following precautions when handling the battery:

- When working with the battery, always wear safety glasses and take care not to allow any battery fluids (acid) to come into contact with skin, clothing or the vehicle body.
- Do not lean over the battery.
- In the event that battery fluid comes into contact with the skin or eyes, immediately wash the affected area with water and seek medical attention. Place a wet sponge or cloth over the affected area until medical attention can be received.
- Always wash your hands after handling the battery support, terminals, and other battery-related parts.
- Do not allow children near the battery.

**■ To prevent damage to the vehicle**

Do not pull- or push-start the vehicle as the three-way catalytic converter may overheat and become a fire hazard.

**NOTICE****■ When handling jumper cables**

When connecting the jumper cables, ensure that they do not become entangled in the cooling fans or engine drive belt.

## If your vehicle overheats

### The following may indicate that your vehicle is overheating.

- The high engine coolant temperature warning light (→P. 272) comes on or flashes, or a loss of engine power is experienced. (For example, the vehicle speed does not increase.)
- Steam comes out from under the hood.

### Correction procedures

1 Stop the vehicle in a safe place and turn off the air conditioning system, and then stop the engine.

2 If you see steam:  
Carefully lift the hood after the steam subsides.

If you do not see steam:  
Carefully lift the hood.

3 After the engine has cooled down sufficiently, inspect the hoses and radiator core (radiator) for any leaks.

- ① Radiator
- ② Cooling fan

If a large amount of coolant leaks, immediately contact your Toyota dealer.

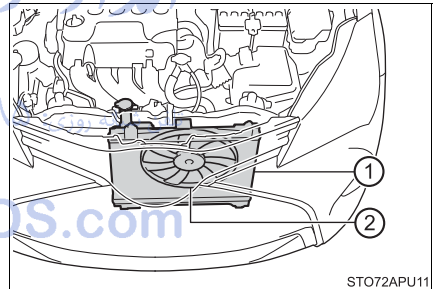

4 The coolant level is satisfactory if it is between the "FULL" and "LOW" lines on the reservoir.

- ① Reservoir
- ② "FULL"
- ③ "LOW"

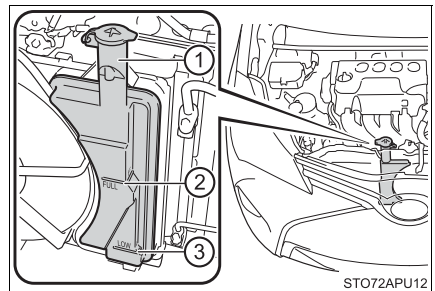

**5** Add coolant if necessary.

Water can be used in an emergency if coolant is unavailable.

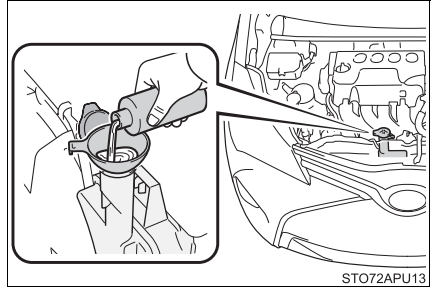

**6** Start the engine and turn the air conditioning system on to check that the radiator cooling fan operates and to check for coolant leaks from the radiator or hoses.

The fan operates when the air conditioning system is turned on immediately after a cold start. Confirm that the fan is operating by checking the fan sound and air flow. If it is difficult to check these, turn the air conditioning system on and off repeatedly.

(The fan may not operate in freezing temperatures.)

**7** If the fan is not operating:

Stop the engine immediately and contact your Toyota dealer.

If the fan is operating:

Have the vehicle inspected at the nearest Toyota dealer.

**⚠ WARNING**

تلفن شبانه روزی: ۰۲۱-۸۸۶۲۰۸۵

**■ To prevent an accident or injury when inspecting under the hood of your vehicle**

Observe the following precautions.

Failure to do so may result in serious injury such as burns.

- If steam is seen coming from under the hood, do not open the hood until the steam has subsided. The engine compartment may be very hot.
- Keep hands and clothing (especially a tie, a scarf or a muffler) away from the fan and belts while the engine is operating.
- Do not loosen the radiator cap or the reservoir cap while the engine and radiator are hot.

**NOTICE****■ When adding engine coolant**

Add coolant slowly after the engine has cooled down sufficiently. Adding cool coolant to a hot engine too quickly can cause damage to the engine.

**■ To prevent damage to the cooling system**

Observe the following precautions:

- Avoid contaminating the coolant with foreign matter (such as sand or dust, etc.).
- Do not use any coolant additives.

امداد خودرو فارما

تلفن شبانه روزی: ۰۲۱-۸۸۶۲۰۸۵

FarmaSOS.com

## If the vehicle becomes stuck

**Carry out the following procedures if the tires spin or the vehicle becomes stuck in mud, dirt or snow:**

- 1 Stop the engine. Set the parking brake and shift the shift lever to P (automatic transmission) or N (manual transmission).
- 2 Remove the mud, snow or sand from around the front wheels.
- 3 Place wood, stones or some other material under the front wheels to help provide traction.
- 4 Restart the engine.
- 5 Shift the shift lever to D or R (automatic transmission) or 1 or R (manual transmission) and release the parking brake. Then, while exercising caution, depress the accelerator pedal.

### ■ When it is difficult to free the vehicle

Press the button to turn off TRC.

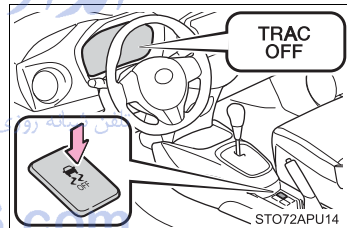

### ■ Emergency hooks

When your vehicle becomes stuck and cannot move, the emergency hooks are used for another vehicle to pull your vehicle out in an emergency.

Your vehicle is not designed to tow another vehicle.

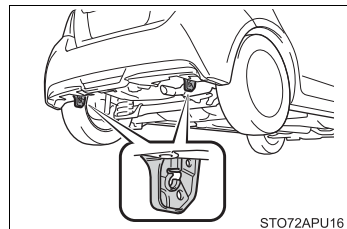

**WARNING****■ When attempting to free a stuck vehicle**

If you choose to push the vehicle back and forth to free it, make sure the surrounding area is clear to avoid striking other vehicles, objects or people. The vehicle may also lunge forward or lunge back suddenly as it becomes free. Use extreme caution.

**■ When shifting the shift lever (automatic transmission)**

Be careful not to shift the shift lever with the accelerator pedal depressed. This may lead to unexpected rapid acceleration of the vehicle that may cause an accident resulting in death or serious injury.

**NOTICE****■ To avoid damage to the transmission and other components**

- Avoid spinning the front wheels and depressing the accelerator pedal more than necessary.
- If the vehicle remains stuck even after these procedures are performed, the vehicle may require towing to be freed.

تلفن شبانه روزی: ۰۲۱-۸۸۶۲۰۸۵

FarmaSOS.com



**Vehicle specifications****8****8-1. Specifications**

Maintenance data (fuel, oil level, etc.).....	306
Fuel information .....	317
Tire information .....	320

**8-2. Customization**

Customizable features .....	333
Items to initialize .....	335

امداد خودرو فارما

تلفن شبانه روزی: ۰۲۱-۸۸۸۶۲۰۸۵

**FarmaSOS.com**

## Maintenance data (fuel, oil level, etc.)

### Dimensions and weights

Overall length		155.5 in. (3950 mm)
Overall width		66.7 in. (1695 mm)
Overall height* <sup>1</sup>		59.4 in. (1510 mm)
Wheelbase		98.8 in. (2510 mm)
Tread	Front	58.5 in. (1485 mm) <sup>*2</sup> 57.5 in. (1460 mm) <sup>*3</sup>
	Rear	57.9 in. (1470 mm) <sup>*2</sup> 56.9 in. (1445 mm) <sup>*3</sup>
Vehicle capacity weight (Occupants + luggage)		845 lb. (380 kg)

\*1: Unladen vehicles

\*2: P175/65R15 tires

\*3: P195/50R16 tires

تلفن شبانه روزی: ۰۲۱-۸۸۶۲۰۸۵

FarmaSOS.com

## Vehicle identification

### ■ Vehicle identification number

The vehicle identification number (VIN) is the legal identifier for your vehicle. This is the primary identification number for your Toyota. It is used in registering the ownership of your vehicle.

This number is stamped under the front passenger's seat.

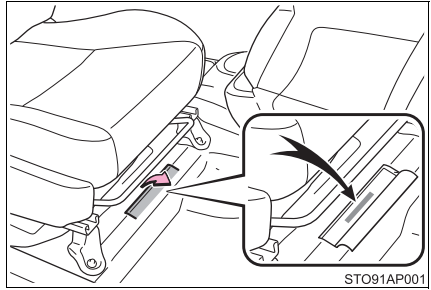

This number is stamped on the top left side of the instrument panel.

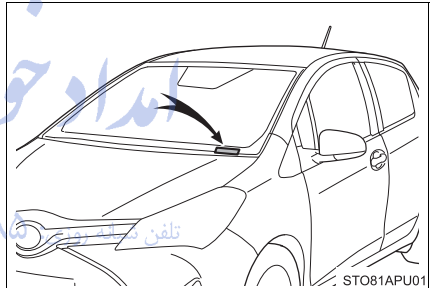

This number is also on the Certification Label on the driver's side of the center pillar.

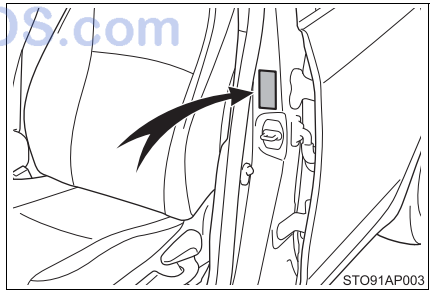

### ■ Engine number

The engine number is stamped on the engine block as shown.

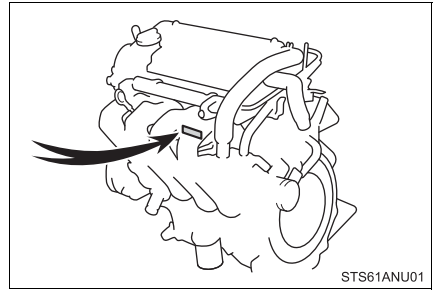

امداد خودرو فارما

تلفن شبانه روزی: ۰۲۱-۸۸۸۶۲۰۸۵

FarmaSOS.com

## Engine

Model	1NZ-FE
Type	4-cylinder in line, 4-cycle, gasoline
Bore and stroke	2.95 × 3.33 in. (75.0 × 84.7 mm)
Displacement	91.3 cu.in. (1497 cm <sup>3</sup> )
Drive belt tension	<p>68 — 90 lbf (300 — 400 N, 31 — 41kgf)*</p> <p>▶ Vehicles without an air conditioning system</p> <div data-bbox="479 430 908 716" data-label="Diagram"> <p>Generator</p> <p>Water pump</p> <p>Crankshaft</p> <p>STS61AN008</p> </div> <p>▶ Vehicles with an air conditioning system</p> <div data-bbox="479 784 908 1070" data-label="Diagram"> <p>Generator</p> <p>Water pump</p> <p>Air conditioning compressor</p> <p>Crankshaft</p> <p>STS61AN001</p> </div>
	<p>*: Drive belt tension measured with Borroughs drive belt tension gauge No. BT-33-73F when the engine is cold (used belt)</p>

## Fuel

Fuel type	Unleaded gasoline only
Octane rating	87 (Research Octane Number 91) or higher
Fuel tank capacity (Reference)	11.1 gal. (42 L, 9.2 Imp.gal.)

## Lubrication system

Oil capacity (Drain and refill -reference*)	
With filter	3.9 qt. (3.7 L, 3.3 Imp.qt.)
Without filter	3.6 qt. (3.4 L, 3.0 Imp.qt.)

\*: The engine oil capacity is a reference quantity to be used when changing the engine oil. Warm up and turn off the engine, wait more than 5 minutes, and check the oil level on the dipstick.

### ■ Engine oil selection

“Toyota Genuine Motor Oil” is used in your Toyota vehicle. Use Toyota approved “Toyota Genuine Motor Oil” or equivalent to satisfy the following grade and viscosity. تلفن شبانه روزی: ۰۲۱-۸۵۰۰۰۰۰۰۰۰

Oil grade: ILSAC GF-5 multigrade engine oil

Recommended viscosity: SAE 5W-30

SAE 5W-30 is the best choice for good fuel economy and good starting in cold weather.

If SAE 5W-30 is not available, SAE 10W-30 oil may be used. However, it should be replaced with SAE 5W-30 at the next oil change.

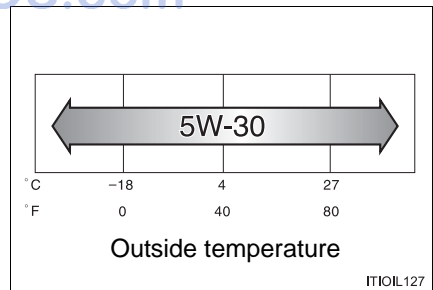

Oil viscosity (5W-30 is explained here as an example):

- The 5W in 5W-30 indicates the characteristic of the oil which allows cold startability. Oils with a lower value before the W allow for easier starting of the engine in cold weather.
- The 30 in 5W-30 indicates the viscosity characteristic of the oil when the oil is at high temperature. An oil with a higher viscosity (one with a higher value) may be better suited if the vehicle is operated at high speeds, or under extreme load conditions.

How to read oil container labels:

The International Lubricant Specification Advisory Committee (ILSAC) Certification Mark is added to some oil containers to help you select the oil you should use.



## Cooling system

Capacity (Reference)	<p>► Automatic transmission 4.9 qt. (4.6 L, 4.0 Imp.qt.)</p> <p>► Manual transmission 5.0 qt. (4.7 L, 4.1 Imp.qt.)</p>
Coolant type	<p>Use either of the following:</p> <ul style="list-style-type: none"> <li>• "Toyota Super Long Life Coolant"</li> <li>• A similar high-quality ethylene glycol-based non-silicate, non-amine, non-nitrite, and non-borate coolant with long-life hybrid organic acid technology</li> </ul> <p>Do not use plain water alone.</p>

## Ignition system

Spark plug	
Make	DENSO SK16R11 NGK IFR5A11
Gap	0.043 in. (1.1 mm)

### NOTICE

#### ■ Iridium-tipped spark plugs

Use only iridium-tipped spark plugs. Do not adjust the spark plug gap.

## Electrical system

Battery	
Specific gravity reading at 68°F (20°C):	1.250 — 1.290 Fully charged 1.160 — 1.200 Half charged 1.060 — 1.100 Discharged
Charging rates	
Quick charge	15 A max.
Slow charge	5 A max.

## Automatic transmission

Fluid capacity*	6.8 qt. (6.4 L, 5.6 Imp.qt.)
Fluid type	Toyota Genuine ATF WS

\*: The fluid capacity is the reference quantity. If replacement is necessary, contact your Toyota dealer.

### NOTICE

#### ■ Transmission fluid type

Using transmission fluid other than “Toyota Genuine ATF WS” may cause deterioration in shift quality, locking up of the transmission accompanied by vibration and, ultimately, damage to the vehicle's transmission.



## Manual transmission

Gear oil capacity (Reference)	2.0 qt. (1.9 L, 1.7 Imp.qt.)
Gear oil type	Use either of the following: <ul style="list-style-type: none"> <li>• “TOYOTA Genuine Manual Transmission Gear Oil LV”</li> <li>• Other gear oil that meets API GL-4 and SAE 75W specifications</li> </ul>

### NOTICE

#### Manual transmission gear oil

Please be aware that depending on the particular characteristics of the gear oil used or the operating conditions, idle sound, shift feeling and/or fuel efficiency may be different or affected. Toyota recommends to use “TOYOTA Genuine Manual Transmission Gear Oil LV” to achieve optimal performance.

## Clutch

Pedal free play	0.2 — 0.6 in. (5 — 15 mm)
Fluid type	SAE J1703, FMVSS No. 116 DOT 3, SAE J1704, or FMVSS No. 116 DOT 4

FarmaSOS.com

## Brakes

Pedal clearance* <sup>1</sup>	<ul style="list-style-type: none"> <li>▶ Rear drum brakes 3.2 in. (81 mm) Min.</li> <li>▶ Rear disc brakes 3.3 in. (84 mm) Min.</li> </ul>
Pedal free play	0.04 — 0.24 in. (1 — 6 mm)
Brake pad wear limit	0.04 in. (1.0 mm)
Brake lining wear limit	0.04 in. (1.0 mm)
Parking brake lever travel* <sup>2</sup>	<ul style="list-style-type: none"> <li>▶ Rear drum brakes 8 — 11 clicks</li> <li>▶ Rear disc brakes 6 — 9 clicks</li> </ul>
Fluid type	SAE J1703 or FMVSS No.116 DOT 3

\*1: Minimum pedal clearance when depressed with a force of 67 lbf (300 N, 31 kgf) while the engine is running

\*2: Parking brake lever travel when pulled up with a force of 45 lbf (200 N, 20 kgf)

## Steering

Free play	Less than 1.2 in. (30 mm)
-----------	---------------------------

## Tires and wheels

### ► 15-inch tires

Tire size	P175/65R15 84H
Tire inflation pressure (Recommended cold tire inflation pressure)	Driving under normal conditions Front: 33 psi (230 kPa, 2.3 kgf/cm <sup>2</sup> or bar) Rear: 33 psi (230 kPa, 2.3 kgf/cm <sup>2</sup> or bar) Never exceed the maximum cold tire inflation pressure indicated on the tire sidewall.
Wheel size	15 × 5.5J
Wheel nut torque	76 ft·lbf (103 N·m, 10.5 kgf·m)

### ► 16-inch tires

Tire size	P195/50R16 83V
Tire inflation pressure (Recommended cold tire inflation pressure)	Driving under normal conditions Front: 32 psi (220 kPa, 2.2 kgf/cm <sup>2</sup> or bar) Rear: 29 psi (200 kPa, 2.0 kgf/cm <sup>2</sup> or bar) Never exceed the maximum cold tire inflation pressure indicated on the tire sidewall.
Wheel size	16 × 6J
Wheel nut torque	76 ft·lbf (103 N·m, 10.5 kgf·m)

### ► Compact spare tires

Tire size	T125/70D16 96M
Tire inflation pressure (Recommended cold tire inflation pressure)	60 psi (420 kPa, 4.2 kgf/cm <sup>2</sup> or bar) Never exceed the maximum cold tire inflation pressure indicated on the tire sidewall.
Wheel size	16 × 4T
Wheel nut torque	76 ft·lbf (103 N·m, 10.5 kgf·m)

## Light bulbs

	Light Bulbs	Bulb No	W	Type
Exterior	Headlights and daytime running lights (if equipped)	Type A 9003 Type B —	60/55 55	A B
	Front fog lights (if equipped)	—	19	C
	Front side marker lights	—	5	D
	Front turn signal lights/ parking lights	7444NA	28/8	E
	Rear turn signal lights	—	21	F
	Stop/tail and rear side marker lights	7443	21/5	D
	Back-up lights	921	16	D
	License plate light	—	5	D
Interior	Personal lights/interior light	—	5	D
	Luggage compartment light	—	5	G

- A: HB2 halogen bulbs      B: HIR2 halogen bulbs  
 C: H16 halogen bulbs      D: Wedge base bulbs (clear)  
 E: Wedge base bulbs (amber)      F: Single end bulbs (clear)  
 G: Double end bulbs

## Fuel information

**You must only use unleaded gasoline in your vehicle. Select octane rating 87 (Research Octane Number 91) or higher. Use of unleaded gasoline with an octane rating lower than 87 may result in engine knocking. Persistent knocking can lead to engine damage.**

At minimum, the gasoline you use should meet the specifications of ASTM D4814 in the U.S.A. and CGSB3.5-M93 in Canada.

### ■ Fuel tank opening for unleaded gasoline

To help prevent incorrect fueling, your vehicle has a fuel tank opening that only accommodates the special nozzle on unleaded fuel pumps.

### ■ Gasoline quality

In very few cases, driveability problems may be caused by the brand of gasoline you are using. If driveability problems persist, try changing the brand of gasoline. If this does not correct the problem, consult your Toyota dealer.

### ■ Gasoline quality standards

- Automotive manufacturers in the U.S.A., Europe and Japan have developed a specification for fuel quality called World-Wide Fuel Charter (WWFC), which is expected to be applied worldwide. تلفن شبانه روز.
- The WWFC consists of four categories that are based on required emission levels. In the U.S., category 4 has been adopted.
- The WWFC improves air quality by lowering emissions in vehicle fleets, and improves customer satisfaction through better performance.

### ■ Recommendation of the use of gasoline containing detergent additives

- Toyota recommends the use of gasoline that contains detergent additives to avoid the build-up of engine deposits.
- All gasoline sold in the U.S.A. contains minimum detergent additives to clean and/or keep clean intake systems, per EPA's lowest additives concentration program.
- Toyota strongly recommends the use of Top Tier Detergent Gasoline. For more information on Top Tier Detergent Gasoline and a list of marketers, please go to the official website [www.toptiergas.com](http://www.toptiergas.com).

### ■ Recommendation of the use of cleaner burning gasoline

Cleaner burning gasoline, including reformulated gasoline that contains oxygenates such as ethanol or MTBE (Methyl Tertiary Butyl Ether) is available in many areas.

Toyota recommends the use of cleaner burning gasoline and appropriately blended reformulated gasoline. These types of gasoline provide excellent vehicle performance, reduce vehicle emissions and improve air quality.

### ■ Non-recommendation of the use of blended gasoline

- Use only gasoline containing up to 15% ethanol.

DO NOT use any flex-fuel or gasoline that could contain more than 15% ethanol, including from any pump labeled E30, E50, E85 (which are only some examples of fuel containing more than 15% ethanol).

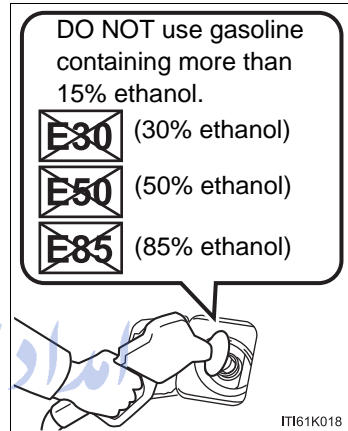

- If you use gasohol in your vehicle, be sure that it has an octane rating no lower than 87. تلفن شبانه روزی: ۰۲۱-۸۸۶۲۰۸۵
- Toyota does not recommend the use of gasoline containing methanol.

### ■ Non-recommendation of the use of gasoline containing MMT

Some gasoline contains an octane enhancing additive called MMT (Methylcyclopentadienyl Manganese Tricarbonyl).

Toyota does not recommend the use of gasoline that contains MMT. If fuel containing MMT is used, your emission control system may be adversely affected.

The malfunction indicator lamp on the instrument cluster may come on. If this happens, contact your Toyota dealer for service.

### ■ If your engine knocks

- Consult your Toyota dealer.
- You may occasionally notice light knocking for a short time while accelerating or driving uphill. This is normal and there is no need for concern.



### NOTICE

#### ■ Notice on fuel quality

- Do not use improper fuels. If improper fuels are used, the engine will be damaged.
- Do not use leaded gasoline.  
Leaded gasoline can cause damage to your vehicle's three-way catalytic converters causing the emission control system to malfunction.
- Do not use gasohol other than the type previously stated.  
Other gasohol may cause fuel system damage or vehicle performance problems.
- Using unleaded gasoline with an octane number or rating lower than the level previously stated will cause persistent heavy knocking.  
At worst, this will lead to engine damage.

#### ■ Fuel-related poor driveability

If poor driveability is encountered after using a different type of fuel (poor hot starting, vaporization, engine knocking, etc.), discontinue the use of that type of fuel.

#### ■ When refueling with gasohol

Take care not to spill gasohol. It can damage your vehicle's paint.

FarmaSOS.com

## Tire information

### Typical tire symbols

#### ► Full-size tire

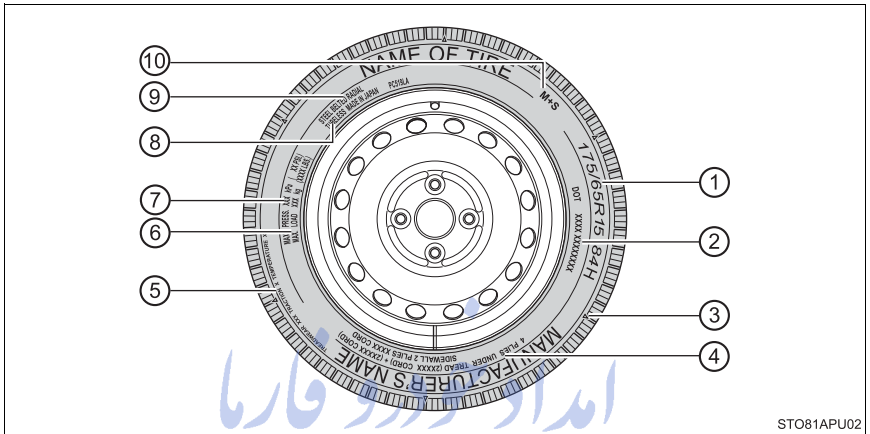

#### ► Compact spare tire

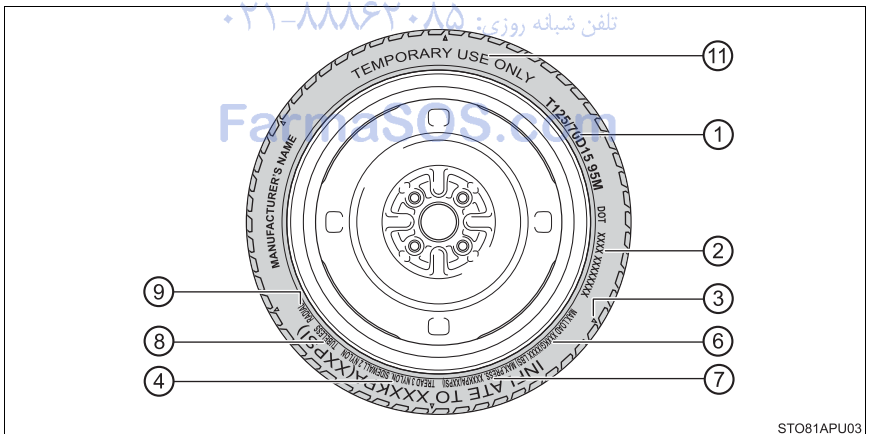



- ① Tire size (→P. 322)
- ② DOT and Tire Identification Number (TIN) (→P. 322)
- ③ Location of treadwear indicators (→P. 223)

④ Tire ply composition and materials

Ply is a layer of rubber-coated parallel cords. Cords are the strands which form the plies in a tire.

⑤ Uniform tire quality grading

For details, see “Uniform Tire Quality Grading” that follows.

- ⑥ Load limit at maximum cold tire inflation pressure (→P. 326)
- ⑦ Maximum cold tire inflation pressure (→P. 315)

This means the pressure to which a tire may be inflated.

⑧ TUBELESS or TUBE TYPE

A tubeless tire does not have a tube and air is directly put into the tire. A tube type tire has a tube inside the tire and the tube maintains the air pressure.

⑨ Radial tires or bias-ply tires

A radial tire has “RADIAL” on the sidewall. A tire not marked “RADIAL” is a bias-ply tire.

⑩ Summer tires or all season tires (→P. 227)

An all season tire has “M+S” on the sidewall. A tire not marked “M+S” is a summer tire.

⑪ “TEMPORARY USE ONLY” (→P. 291)

A compact spare tire is identified by the phrase “TEMPORARY USE ONLY” molded on its sidewall. This tire is designed for temporary emergency use only.

## Typical DOT and Tire Identification Number (TIN)

- ① DOT symbol\*
- ② Tire Identification Number (TIN)
- ③ Tire manufacturer's identification mark
- ④ Tire size code
- ⑤ Manufacturer's optional tire type code (3 or 4 letters)
- ⑥ Manufacturing week
- ⑦ Manufacturing year

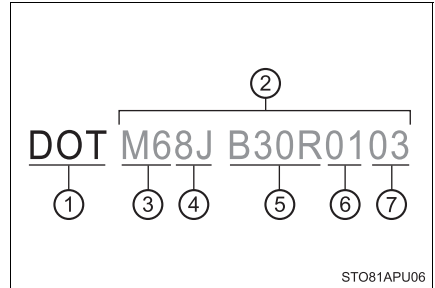

\*: The DOT symbol certifies that the tire conforms to applicable Federal Motor Vehicle Safety Standards.

## Tire size

### ■ Typical tire size information

The illustration indicates typical tire size.

- ① Tire use  
(P = Passenger car,  
T = Temporary use)
- ② Section width (millimeters)
- ③ Aspect ratio  
(tire height to section width)
- ④ Tire construction code  
(R = Radial, D = Diagonal)
- ⑤ Wheel diameter (inches)
- ⑥ Load index (2 digits or 3 digits)
- ⑦ Speed symbol (alphabet with one letter)

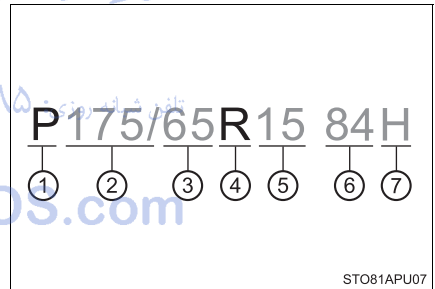

### ■ Tire dimensions

- ① Section width
- ② Tire height
- ③ Wheel diameter

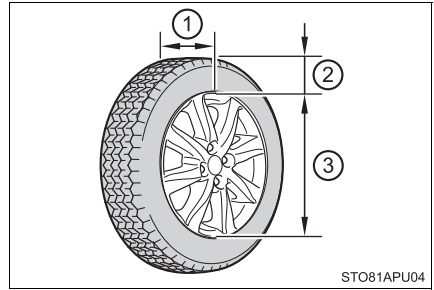

### Tire section names

- ① Bead
- ② Sidewall
- ③ Shoulder
- ④ Tread
- ⑤ Belt
- ⑥ Inner liner
- ⑦ Reinforcing rubber
- ⑧ Carcass
- ⑨ Rim lines
- ⑩ Bead wires
- ⑪ Chafer

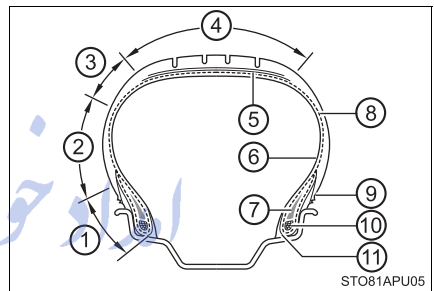

تلفن شبانه روزی: ۰۲۱-۸۸۶۲۰۸۵

FarmaSOS.com

## Uniform Tire Quality Grading

This information has been prepared in accordance with regulations issued by the National Highway Traffic Safety Administration of the U.S. Department of Transportation.

It provides the purchasers and/or prospective purchasers of Toyota vehicles with information on uniform tire quality grading.

Your Toyota dealer will help answer any questions you may have as you read this information.

### ■ DOT quality grades

All passenger vehicle tires must conform to Federal Safety Requirements in addition to these grades. Quality grades can be found where applicable on the tire sidewall between tread shoulder and maximum section width.

For example: Treadwear 200 Traction AA Temperature A

### ■ Treadwear

The treadwear grade is a comparative rating based on the wear rate of the tire when tested under controlled conditions on a specified government test course.

For example, a tire graded 150 would wear one and a half (1 - 1/2) times as well on the government course as a tire graded 100.

The relative performance of tires depends upon the actual conditions of their use. Performance may differ significantly from the norm due to variations in driving habits, service practices and differences in road characteristics and climate.

### ■ Traction AA, A, B, C

The traction grades, from highest to lowest, are AA, A, B and C, and they represent the tire's ability to stop on wet pavement as measured under controlled conditions on specified government test surfaces of asphalt and concrete.

A tire marked C may have poor traction performance.

Warning: The traction grade assigned to this tire is based on braking (straight ahead) traction tests and does not include cornering (turning) traction.

### ■ Temperature A, B, C

The temperature grades are A (the highest), B, and C, representing the tire's resistance to the generation of heat and its ability to dissipate heat when tested under controlled conditions on a specified indoor laboratory test wheel.

Sustained high temperature can cause the material of the tire to degenerate and reduce tire life, and excessive temperature can lead to sudden tire failure.

The grade C corresponds to a level of performance which all passenger car tires must meet under the Federal Motor Vehicle Safety Standard No. 109.

Grades B and A represent higher levels of performance on the laboratory test wheel than the minimum required by law.

Warning: The temperature grades for this tire are established for a tire that is properly inflated and not overloaded.

Excessive speed, underinflation, or excessive loading, either separately or in combination, can cause heat buildup and possible tire failure.

### Glossary of tire terminology

Tire related term	Meaning
Cold tire inflation pressure	Tire pressure when the vehicle has been parked for three hours or more, or has not been driven more than 1 mile or 1.5 km under that condition
Maximum inflation pressure	The maximum cold inflated pressure to which a tire may be inflated, shown on the sidewall of the tire
Recommended inflation pressure	Cold tire inflation pressure recommended by a manufacturer
Accessory weight	The combined weight (in excess of those standard items which may be replaced) of automatic transmission, power steering, power brakes, power windows, power seats, radio and heater, to the extent that these items are available as factory-installed equipment (whether installed or not)
Curb weight	The weight of a motor vehicle with standard equipment, including the maximum capacity of fuel, oil and coolant, and if so equipped, air conditioning and additional weight optional engine
Maximum loaded vehicle weight	The sum of: (a) Curb weight (b) Accessory weight (c) Vehicle capacity weight (d) Production options weight
Normal occupant weight	150 lb. (68 kg) times the number of occupants specified in the second column of Table 1* that follows

Tire related term	Meaning
Occupant distribution	Distribution of occupants in a vehicle as specified in the third column of Table 1* below
Production options weight	The combined weight of installed regular production options weighing over 5 lb. (2.3 kg) in excess of the standard items which they replace, not previously considered in curb weight or accessory weight, including heavy duty brakes, ride levelers, roof rack, heavy duty battery, and special trim
Rim	A metal support for a tire or a tire and tube assembly upon which the tire beads are seated
Rim diameter (Wheel diameter)	Nominal diameter of the bead seat
Rim size designation	Rim diameter and width
Rim type designation	The industry manufacturer's designation for a rim by style or code
Rim width	Nominal distance between rim flanges
Vehicle capacity weight (Total load capacity)	The rated cargo and luggage load plus 150 lb. (68 kg) times the vehicle's designated seating capacity
Vehicle maximum load on the tire	The load on an individual tire that is determined by distributing to each axle its share of the maximum loaded vehicle weight, and dividing by two
Vehicle normal load on the tire	The load on an individual tire that is determined by distributing to each axle its share of curb weight, accessory weight, and normal occupant weight (distributed in accordance with Table 1* below), and dividing by two

Tire related term	Meaning
Weather side	The surface area of the rim not covered by the inflated tire
Bead	The part of the tire that is made of steel wires, wrapped or reinforced by ply cords and that is shaped to fit the rim
Bead separation	A breakdown of the bond between components in the bead
Bias ply tire	A pneumatic tire in which the ply cords that extend to the beads are laid at alternate angles substantially less than 90 degrees to the centerline of the tread
Carcass	The tire structure, except tread and sidewall rubber which, when inflated, bears the load
Chunking	The breaking away of pieces of the tread or sidewall
Cord	The strands forming the plies in the tire
Cord separation	The parting of cords from adjacent rubber compounds
Cracking	Any parting within the tread, sidewall, or inner-liner of the tire extending to cord material
CT	A pneumatic tire with an inverted flange tire and rim system in which the rim is designed with rim flanges pointed radially inward and the tire is designed to fit on the underside of the rim in a manner that encloses the rim flanges inside the air cavity of the tire
Extra load tire	A tire designed to operate at higher loads and at higher inflation pressures than the corresponding standard tire
Groove	The space between two adjacent tread ribs



Tire related term	Meaning
Innerliner	The layer(s) forming the inside surface of a tubeless tire that contains the inflating medium within the tire
Innerliner separation	The parting of the innerliner from cord material in the carcass
Intended outboard sidewall	(a) The sidewall that contains a whitewall, bears white lettering, or bears manufacturer, brand, and/or model name molding that is higher or deeper than the same molding on the other sidewall of the tire, or (b) The outward facing sidewall of an asymmetrical tire that has a particular side that must always face outward when mounted on a vehicle
Light truck (LT) tire	A tire designated by its manufacturer as primarily intended for use on lightweight trucks or multipurpose passenger vehicles
Load rating	The maximum load that a tire is rated to carry for a given inflation pressure
Maximum load rating	The load rating for a tire at the maximum permissible inflation pressure for that tire
Maximum permissible inflation pressure	The maximum cold inflation pressure to which a tire may be inflated
Measuring rim	The rim on which a tire is fitted for physical dimension requirements
Open splice	Any parting at any junction of tread, sidewall, or innerliner that extends to cord material
Outer diameter	The overall diameter of an inflated new tire

Tire related term	Meaning
Overall width	The linear distance between the exteriors of the sidewalls of an inflated tire, including elevations due to labeling, decorations, or protective bands or ribs
Passenger car tire	A tire intended for use on passenger cars, multipurpose passenger vehicles, and trucks, that have a gross vehicle weight rating (GVWR) of 10,000 lb. or less
Ply	A layer of rubber-coated parallel cords
Ply separation	A parting of rubber compound between adjacent plies
Pneumatic tire	A mechanical device made of rubber, chemicals, fabric and steel or other materials, that, when mounted on an automotive wheel, provides the traction and contains the gas or fluid that sustains the load
Radial ply tire	A pneumatic tire in which the ply cords that extend to the beads are laid at substantially 90 degrees to the centerline of the tread
Reinforced tire	A tire designed to operate at higher loads and at higher inflation pressures than the corresponding standard tire
Section width	The linear distance between the exteriors of the sidewalls of an inflated tire, excluding elevations due to labeling, decoration, or protective bands
Sidewall	That portion of a tire between the tread and bead
Sidewall separation	The parting of the rubber compound from the cord material in the sidewall

Tire related term	Meaning
Snow tire	A tire that attains a traction index equal to or greater than 110, compared to the ASTM E-1136 Standard Reference Test Tire, when using the snow traction test as described in ASTM F-1805-00, Standard Test Method for Single Wheel Driving Traction in a Straight Line on Snow-and Ice-Covered Surfaces, and which is marked with an Alpine Symbol (  ) on at least one sidewall
Test rim	The rim on which a tire is fitted for testing, and may be any rim listed as appropriate for use with that tire
Tread	That portion of a tire that comes into contact with the road
Tread rib	A tread section running circumferentially around a tire
Tread separation	Pulling away of the tread from the tire carcass
Treadwear indicators (TWI)	The projections within the principal grooves designed to give a visual indication of the degrees of wear of the tread
Wheel-holding fixture	The fixture used to hold the wheel and tire assembly securely during testing

FarmaSOS.com

\*: Table 1 — Occupant loading and distribution for vehicle normal load for various designated seating capacities

Designated seating capacity, Number of occupants	Vehicle normal load, Number of occupants	Occupant distribution in a normally loaded vehicle
2 through 4	2	2 in front
5 through 10	3	2 in front, 1 in second seat
11 through 15	5	2 in front, 1 in second seat, 1 in third seat, 1 in fourth seat
16 through 20	7	2 in front, 2 in second seat, 2 in third seat, 1 in fourth seat

امداد خودرو فارما

تلفن شبانه روزی: ۰۲۱-۸۸۶۲۰۸۵

FarmaSOS.com

## Customizable features

Your vehicle includes a variety of electronic features that can be personalized to suit your preferences. Programming these preferences requires specialized equipment and may be performed by your Toyota dealer.

### Customizable features

Some function settings are changed simultaneously with other functions being customized. Contact your Toyota dealer for further details.

#### ■ Wireless remote control (→P. 85, 89)

Function	Default setting	Customized setting
Unlocking operation	The driver's door unlocked in one step, all the doors unlocked in two steps	All the doors unlocked in one step
Time elapsed before automatic door lock function is activated if door is not opened after being unlocked	60 seconds	30 seconds
		120 seconds

#### ■ Door lock (→P. 89)

Function	Default setting	Customized setting
Unlocking using a key	The driver's door unlocked in one step, all the doors unlocked in two steps	All the doors unlocked in one step

### ■ Seat belt reminder buzzer (→P. 274)

Function	Default setting	Customized setting
Vehicle speed linked seat belt reminder buzzer	On	Off

#### WARNING

##### ■ During customization

As the engine needs to be running during customization, ensure that the vehicle is parked in a place with adequate ventilation. In a closed area such as a garage, exhaust gases including harmful carbon monoxide (CO) may collect and enter the vehicle. This may lead to death or a serious health hazard.

#### NOTICE

##### ■ During customization

To prevent battery discharge, ensure that the engine is running while customizing features.

تلفن شبانه روزی: ۰۲۱-۸۸۶۲۰۸۵

FarmaSOS.com

## Items to initialize

The following items must be initialized for normal system operation after such cases as the battery being reconnected, or maintenance being performed on the vehicle:

Item	When to initialize	Reference
Maintenance data (except Canada)	After the maintenance is performed	P. 201
Tire pressure warning system (if equipped)	When rotating the tires on vehicles with differing front and rear tire inflation pressures	P. 224

امداد خودرو فارما

تلفن شبانه روزی: ۰۲۱-۸۸۸۶۲۰۸۵

FarmaSOS.com

امداد خودرو فارما

تلفن شبانه روزی: ۰۲۱-۸۸۸۶۲۰۸۵

**FarmaSOS.com**



## For owners

## 9

Reporting safety defects for U.S. owners.....	338
Seat belt instructions for Canadian owners (in French).....	339
SRS airbag instructions for Canadian owners (in French).....	341

امداد خودرو فارما

تلفن شبانه روزی: ۰۲۱-۸۸۸۶۲۰۸۵

[FarmaSOS.com](http://FarmaSOS.com)

## Reporting safety defects for U.S. owners

If you believe that your vehicle has a defect which could cause a crash or could cause injury or death, you should immediately inform the National Highway Traffic Safety Administration (NHTSA) in addition to notifying Toyota Motor Sales, U.S.A., Inc. (Toll-free: 1-800-331-4331).

If NHTSA receives similar complaints, it may open an investigation, and if it finds that a safety defect exists in a group of vehicles, it may order a recall and remedy campaign. However, NHTSA cannot become involved in individual problems between you, your dealer, or Toyota Motor Sales, U.S.A., Inc.

To contact NHTSA, you may call the Vehicle Safety Hotline toll-free at 1-888-327-4236 (TTY: 1-800-424-9153); go to <http://www.safercar.gov>; or write to: Administrator, NHTSA, 1200 New Jersey Ave, S.E., Washington, DC 20590. You can also obtain other information about motor vehicle safety from <http://www.safercar.gov>.

تلفن شبانه روزی: ۰۲۱-۸۸۶۲۰۸۵

FarmaSOS.com

## Seat belt instructions for Canadian owners (in French)

The following is a French explanation of seat belt instructions extracted from the seat belt section in this manual.

See the seat belt section for more detailed seat belt instructions in English.

### Utilisation correcte des ceintures de sécurité

- Déroulez la sangle diagonale de telle sorte qu'elle passe bien sur l'épaule, sans pour autant être en contact avec le cou ou glisser de l'épaule.
- Placez la sangle abdominale le plus bas possible sur les hanches.
- Réglez la position du dossier de siège. Asseyez-vous le dos le plus droit possible et calez-vous bien dans le siège.
- Ne pas vriller la ceinture de sécurité.

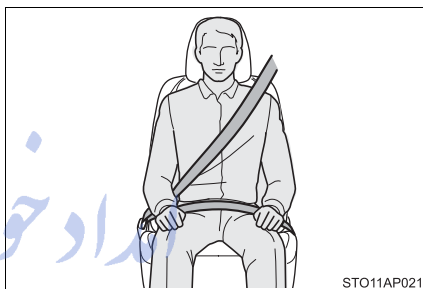

STO11AP021

### Entretien et soin

#### ■ Ceintures de sécurité

Nettoyez avec un chiffon ou une éponge humectée d'eau savonneuse tiède. Par ailleurs, vérifiez régulièrement que les ceintures ne sont pas effilochées, entaillées, ou ne paraissent pas exagérément usées.

**⚠ ATTENTION**

■ **Port de la ceinture de sécurité**

- Ne pas passer la sangle diagonale sous le bras.
- Faites toujours passer votre ceinture de sécurité au plus bas sur vos hanches et bien dans l'axe.

■ **Dommages et usure de la ceinture de sécurité**

Inspectez les ceintures de sécurité périodiquement. Contrôlez qu'elles ne sont pas entaillées, effilochées, et que leurs ancrages ne sont pas desserrés. Ne pas utiliser une ceinture de sécurité défectueuse avant qu'elle ne soit remplacée. Une ceinture de sécurité défectueuse n'apporte aucune garantie de protection de l'occupant contre des blessures graves, voire mortelles.

■ **Lorsque vous utilisez la ceinture de sécurité du siège central arrière**

- Ne pas utiliser la ceinture de sécurité du siège central arrière avec une de ses deux boucles déverrouillée.

Si une seule des boucles est verrouillée, tout freinage brusque ou collision peut entraîner des blessures graves, voire mortelles.



تلفن شبانه روزی: ۰۲۱-۸۸۶۲۰۸۵

FarmaSOS.com

## SRS airbag instructions for Canadian owners (in French)

The following is a French explanation of SRS airbag instructions extracted from the SRS airbag section in this manual.

See the SRS airbag section for more detailed SRS airbag instructions in English.

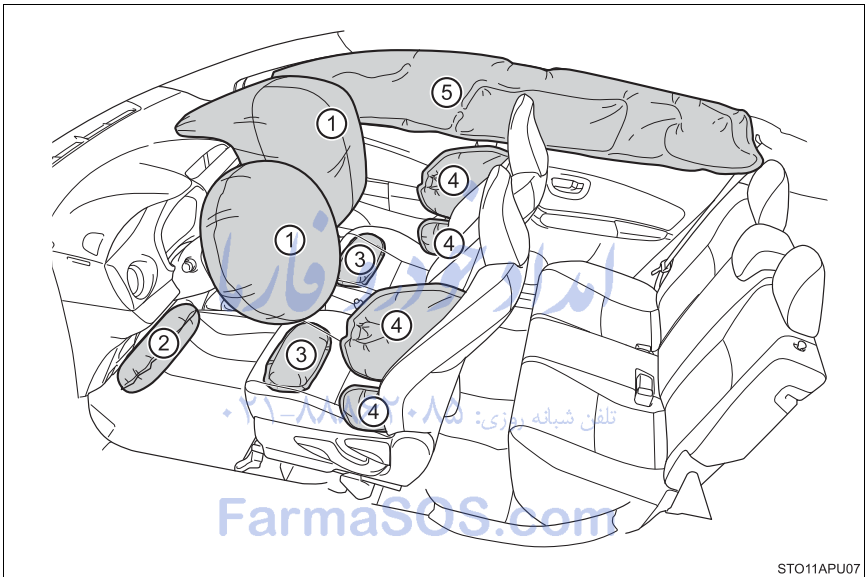

STO11APU07

### ◆ Coussins gonflables SRS frontaux

---

- ① Coussins gonflables SRS conducteur/passager avant  
Participent à la protection de la tête et du thorax du conducteur et du passager avant contre les chocs avec les éléments de l'habitacle
- ② Coussin gonflable SRS de genoux conducteur  
Contribue à accroître la protection du conducteur
- ③ Coussins gonflables SRS d'assise de siège  
Peuvent contribuer à retenir le conducteur et le passager avant

### ◆ Coussins gonflables SRS latéraux et rideau

---

- ④ Coussins gonflables SRS latéraux  
Participent à la protection du haut du corps des occupants des sièges avant
- ⑤ Coussins gonflables SRS rideau  
Participent principalement à la protection de la tête des occupants assis aux places latérales

تلفن شبانه روزی: ۰۲۱-۸۸۶۲۰۸۵

FarmaSOS.com

## Composition du système de coussins gonflables SRS

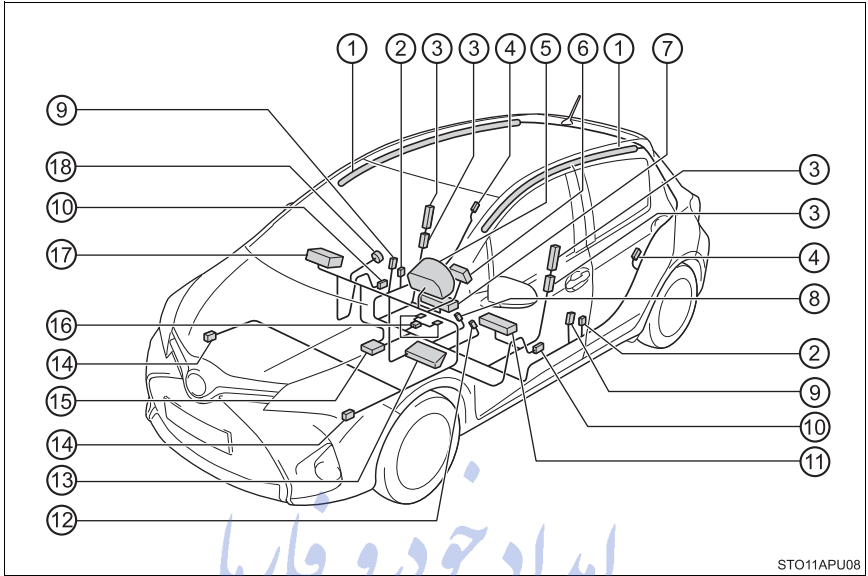

STO11APU08

- |   |  |
|---|--|
| ① Coussins gonflables rideau                                    | ⑪ Coussin gonflable d'assise de siège  |
| ② Capteurs d'impact latéral (avant)                             | ⑫ Contacteur de boucle de ceinture de sécurité conducteur                        |
| ③ Coussins gonflables latéraux                                  | ⑬ Coussin gonflable de genoux conducteur   |
| ④ Capteurs d'impact latéral (arrière)                           | ⑭ Capteurs d'impact avant  |
| ⑤ Témoin d'alerte SRS   | ⑮ Boîtier électronique de coussins gonflables                                    |
| ⑥ Coussin gonflable conducteur                                  | ⑯ Système de classification d'occupant du siège passager avant (ECU et capteurs) |
| ⑦ Coussin gonflable d'assise de siège                           | ⑰ Coussin gonflable passager avant   |
| ⑧ Contacteur de boucle de ceinture de sécurité passager avant   | ⑱ Témoins indicateurs "AIR BAG ON" et "AIR BAG OFF"                              |
| ⑨ Prétensionneurs et limiteurs d'effort de ceinture de sécurité |  |
| ⑩ Capteurs d'impact latéral (porte avant)                       |  |

Votre véhicule est équipé de COUSSINS GONFLABLES INTELLIGENTS (ADVANCED AIRBAGS) conçus selon les normes de sécurité américaines applicables aux véhicules à moteur (FMVSS208). Le boîtier électronique de coussins gonflables (ECU) utilise les informations reçues des capteurs, etc. détaillés dans le schéma ci-dessus de composition du système pour commander le déploiement des coussins gonflables. Ces informations comprennent des informations sur la gravité de la collision et les occupants. Le déploiement rapide des coussins gonflables est obtenu au moyen d'une réaction chimique dans les dispositifs pyrotechniques, qui produit un gaz inoffensif permettant d'amortir le mouvement des occupants.

امداد خودرو فارما

تلفن شبانه روزی: ۰۲۱-۸۸۶۲۰۸۵

FarmaSOS.com



 ATTENTION

### ■ Précautions avec les coussins gonflables SRS

Respectez les précautions suivantes concernant les coussins gonflables SRS.

À défaut, des blessures graves, voire mortelles, pourraient s'ensuivre.

- Le conducteur et tous les passagers à bord du véhicule doivent porter leur ceinture de sécurité correctement.

Les coussins gonflables SRS sont des dispositifs de protection complémentaires aux ceintures de sécurité.

- Le coussin gonflable SRS conducteur se déploie avec une puissance considérable et peut occasionner des blessures graves, voire mortelles, notamment lorsque le conducteur se trouve très près du coussin gonflable.

L'autorité fédérale chargée de la sécurité routière aux États-Unis, la NHTSA (National Highway Traffic Safety Administration) conseille:

Sachant que la zone de danger pour le coussin gonflable conducteur se trouve dans les premiers 50 à 75 mm (2 à 3 pouces) du déploiement, placez-vous à 250 mm (10 pouces) du coussin gonflable conducteur pour garantir une marge de sécurité suffisante. Cette distance est à mesurer entre le moyeu du volant de direction et le sternum. Si vous êtes assis à moins de 10 in. (250 mm), vous pouvez changer votre position de conduite de plusieurs façons:

- Reculez votre siège le plus possible, tout en continuant à pouvoir atteindre confortablement les pédales.
- Inclinez légèrement le dossier du siège. Bien que les véhicules soient différents les uns des autres, la plupart des conducteurs peuvent s'asseoir à une distance de 250 mm (10 in.), même avec le siège conducteur complètement avancé, simplement en inclinant un peu le dossier de siège. Si vous avez des difficultés à voir la route après avoir incliné votre siège, utilisez un coussin ferme et antidérapant pour vous rehausser ou, si votre véhicule est équipé du réglage en hauteur du siège, remontez-le.
- Si votre volant de direction est réglable, inclinez-le vers le bas. Cela vous permet d'orienter le coussin gonflable vers votre buste plutôt que vers la tête et le cou.

Le siège doit être réglé selon les recommandations de la NHTSA ci-dessus, tout en conservant le contrôle des pédales et du volant, et la vue des commandes au tableau de bord.

**ATTENTION**

**Précautions avec les coussins gonflables SRS**

● Si vous attachez une rallonge de ceinture de sécurité aux boucles des ceintures de sièges avant, mais pas au pêne de la ceinture de sécurité proprement dite, les coussins gonflables SRS frontaux déterminent que le conducteur et le passager avant portent leur ceinture de sécurité, alors même qu'elle n'est pas attachée. Dans ce cas, les coussins gonflables SRS frontaux risquent de ne pas se déployer correctement en cas de collision, causant des blessures graves, voire mortelles. Veillez à porter la ceinture de sécurité avec la rallonge de ceinture de sécurité.



● Le coussin gonflable SRS passager avant se déploie également avec une puissance considérable et peut occasionner des blessures graves, voire mortelles, notamment lorsque le passager avant se trouve très près du coussin gonflable. Le siège du passager avant doit se trouver le plus loin possible du coussin gonflable et le dossier doit être réglé de manière à ce que le passager avant soit assis bien droit.

● Le déploiement d'un coussin gonflable peut infliger des blessures graves, voire mortelles, aux nourrissons et aux enfants mal assis et/ou mal attachés. Installez dans un siège de sécurité enfant les enfants trop jeunes pour pouvoir utiliser la ceinture de sécurité. Toyota recommande vivement que tous les nourrissons et enfants soient installés dans les sièges arrière du véhicule et convenablement attachés. Les sièges arrière sont plus sûrs pour les nourrissons et les enfants que le siège passager avant.

● N'installez jamais un siège de sécurité enfant type dos à la route sur le siège passager avant, même si le voyant "AIR BAG OFF" est allumé. En cas d'accident, la force exercée par le déploiement rapide du coussin gonflable passager avant peut causer des blessures graves, voire mortelles à un enfant, si le siège de sécurité enfant type dos à la route est installé sur le siège passager avant.

● Ne pas s'asseoir sur le bord du siège et ne pas s'appuyer contre la planche de bord.

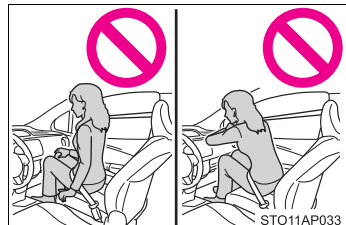

## ⚠ ATTENTION

### ■ Précautions avec les coussins gonflables SRS

- Ne pas laisser un enfant rester debout devant le coussin gonflable SRS passager avant ni assis sur les genoux du passager avant.
- Ne pas laisser les occupants des sièges avant voyager avec un objet sur les genoux.
- Ne pas s'appuyer contre la porte, contre le rail latéral de toit ou contre les montants avant, latéraux et arrière.

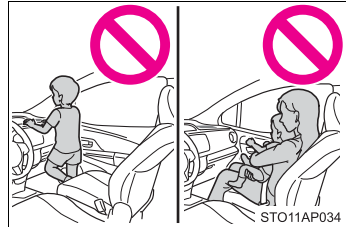

- Interdisez à quiconque de s'agenouiller sur le siège passager en appui contre la porte ou de sortir la tête ou les mains à l'extérieur du véhicule.

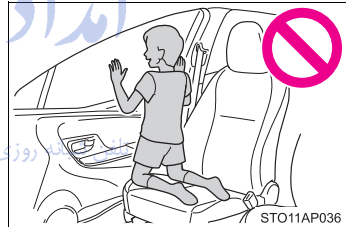

- Ne rien fixer ou disposer sur la planche de bord, la garniture centrale du moyeu de volant de direction et la partie inférieure du tableau de bord.

Lors du déploiement des coussins gonflables SRS conducteur, passager avant et de genoux conducteur, tout objet risque de se transformer en projectile.

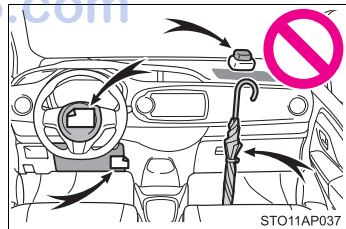

## ⚠ ATTENTION

### ■ Précautions avec les coussins gonflables SRS

- Ne rien fixer aux portes, à la vitre de pare-brise, aux vitres latérales, aux montants avant et arrière, au rail latéral de toit et à la poignée de maintien.

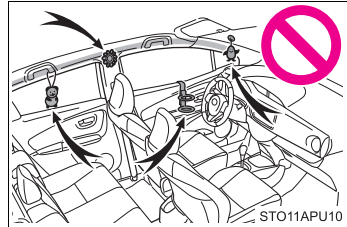

- Ne pas attacher à la clé des objets lourds, pointus ou très durs, comme d'autres clés par exemple. Ces objets risquent d'entraver le déploiement du coussin gonflable SRS de genoux conducteur ou d'être projetés en direction du siège conducteur par la force de déploiement, constituant ainsi un danger potentiel.

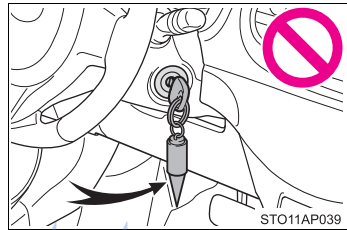

- Ne pas suspendre aux crochets à vêtements un cintre nu ni aucun objet dur ou tranchant. En cas de déploiement des coussins gonflables SRS rideau, tous ces objets pourraient se transformer en projectiles et causer des blessures graves, voire mortelles.
- Si une housse en vinyle recouvre la partie où le coussin gonflable SRS de genoux conducteur se déploie, veillez à l'enlever.
- N'utilisez aucun accessoire de siège venant recouvrir les zones de déploiement des coussins gonflables SRS latéraux et des coussins gonflables SRS d'assise de siège, car il risquerait d'en gêner le déploiement. De tels accessoires peuvent empêcher les coussins gonflables latéraux et d'assise de siège de fonctionner correctement, neutraliser le système ou provoquer le déploiement accidentel des coussins gonflables latéraux et d'assise de siège, provoquant ainsi des blessures graves, voire mortelles.
- Évitez de faire subir des chocs ou des pressions excessives aux parties renfermant les composants des coussins gonflables SRS. En effet, cela pourrait entraîner un mauvais fonctionnement des coussins gonflables SRS.
- Ne touchez aucun composant du système immédiatement après le déclenchement (déploiement) des coussins gonflables SRS, car ils sont alors encore très chauds.

 ATTENTION

### ■ Précautions avec les coussins gonflables SRS

- Si vous avez des difficultés à respirer après le déploiement des coussins gonflables SRS, ouvrez une porte ou une vitre pour faire entrer de l'air frais, ou bien descendez du véhicule si cela ne présente pas de danger. Retirez tout résidu dès que possible afin d'éviter d'éventuelles irritations de la peau.
- Si les parties renfermant les coussins gonflables SRS, telles que la garniture centrale du volant de direction et les garnitures de montants avant et arrière, apparaissent abîmées ou craquelées, faites-les remplacer par votre concessionnaire Toyota.
- Ne rien poser sur le siège du passager avant, comme un coussin par exemple. Cela a pour conséquence de répartir le poids du passager sur toute la surface du siège, ce qui empêche le capteur de détecter normalement le poids du passager. En conséquence, les coussins gonflables SRS frontaux du passager avant peuvent ne pas se déployer en cas de collision.

### ■ Modification et élimination en fin de vie des éléments du système de coussins gonflables SRS

Consultez impérativement votre concessionnaire Toyota si vous avez besoin d'intervenir sur votre véhicule ou de procéder à l'une des modifications suivantes. Les coussins gonflables SRS peuvent ne pas fonctionner correctement ou se déployer (se gonfler) accidentellement, provoquant ainsi des blessures graves, voire mortelles. تلفن شبانه روزی

- Installation, dépose, démontage et réparations des coussins gonflables SRS
- Réparations, modifications, démontage ou remplacement du volant, du tableau de bord, de la planche de bord, des sièges ou de leur garnissage, des montants avant, latéraux et arrière ou des rails latéraux de toit
- Réparation ou modification des ailes avant, du bouclier avant, ou des flancs de l'habitacle
- Installation d'une protection de calandre (pare-buffle ou pare-kangourou, etc.), d'un chasse-neige, d'un treuil
- Modification des suspensions du véhicule
- Installation d'appareils électroniques, tels qu'un émetteur/récepteur radio ou lecteur de CD
- Aménagements apportés au véhicule pour une personne atteinte d'un handicap physique.

# امداد خودرو فارما

تلفن شبانه روزی: ۰۲۱-۸۸۸۶۲۰۸۵

**FarmaSOS.com**

**Index**

What to do if... (Troubleshooting) .....	352
Alphabetical index .....	355

امداد خودرو فارما

تلفن شبانه روزی: ۰۲۱-۸۸۸۶۲۰۸۵

**FarmaSOS.com**

## What to do if... (Troubleshooting)

**If you have a problem, check the following before contacting your Toyota dealer.**

### **The doors cannot be locked, unlocked, opened or closed**



#### **You lose your keys**

- If you lose your keys, new genuine keys can be made by your Toyota dealer. (→P. 86)



#### **The doors cannot be locked or unlocked**

- Is the key battery weak or depleted? (→P. 240)
- The function may not operate properly due to the condition of the radio wave. (→P. 87)



#### **The rear door cannot be opened**

- Is the child-protector lock set?  
The rear door cannot be opened from inside the vehicle when the lock is set. Open the rear door from outside and then unlock the child-protector lock. (→P. 92)



## If you think something is wrong



### The engine does not start

- Vehicles with a manual transmission:  
Did you turn the key while firmly depressing the clutch pedal? (→P. 136)
- Vehicles with an automatic transmission:  
Is the shift lever in P? (→P. 136)
- Is the battery discharged? (→P. 297)



### The shift lever cannot be shifted from P even if you depress the brake pedal (vehicles with an automatic transmission)

- Is the engine switch in the "ON" position?  
If you cannot release the shift lever by depressing the brake pedal with the engine switch in the "ON" position. (→P. 296)



### The steering wheel cannot be turned after the engine is stopped

- It is locked to prevent theft of the vehicle if the key is pulled from the engine switch. (→P. 137)



### The windows do not open or close by operating the power window switches

- Is the window lock switch pressed?  
The power window except for the one at the driver's seat cannot be operated if the window lock switch is pressed. (→P. 113)



### A warning buzzer sounds during driving

- The seat belt reminder light is flashing  
Is the driver wearing the seat belts? (→P. 274)
- The parking brake indicator is on  
Is the parking brake released? (→P. 272)

Depending on the situation, other types of warning buzzer may also sound. (→P. 272)



### A warning light turns on

- When a warning light turns on, refer to P. 272.

## When a problem has occurred



### If you have a flat tire

- Stop the vehicle in a safe place and replace the flat tire with the spare tire. (→P. 281)

تلفن شبانه روزی: ۰۲۱-۸۸۶۲۰۸۵



### The vehicle becomes stuck

- Try the procedure for when the vehicle becomes stuck in mud, dirt, or snow. (→P. 303)

FarmaSOS.com

## Alphabetical index

## A

<b>A/C</b> .....	172
Air conditioning filter .....	238
Manual air conditioning system .....	172
<b>ABS (Anti-lock Brake System)</b> .....	162
Function .....	162
Warning light .....	273
<b>Air conditioning filter</b> .....	238
<b>Air conditioning system</b> .....	172
Air conditioning filter .....	238
Manual air conditioning system .....	172
<b>Airbags</b> .....	34
Airbag operating conditions ....	41
Airbag precautions for your child .....	36
Airbag warning light .....	273
Correct driving posture .....	24
Curtain shield airbag operating conditions .....	41
Curtain shield airbag precautions .....	39
Front passenger occupant classification system .....	46
General airbag precautions ....	36
Locations of airbags .....	34
Modification and disposal of airbags .....	40
Side airbag operating conditions .....	41
Side airbag precautions .....	38
Side and curtain shield airbags operating conditions .....	41
Side and curtain shield airbags precautions .....	38
SRS airbags .....	34

<b>Anchor brackets</b> .....	58
<b>Anti-lock Brake System (ABS)</b> .....	162
Function .....	162
Warning light .....	273
<b>Assist grips</b> .....	192
<b>Audio input</b> .....	181
<b>Automatic transmission</b> .....	139
If the shift lever cannot be shifted from P .....	296
<b>AUX port</b> .....	181

## B

<b>Back door</b>	
Back door .....	94
Luggage compartment light .....	95
<b>Back-up lights</b>	
Replacing light bulb .....	258
Wattage .....	316
<b>Battery</b> .....	219
If the battery is discharged ...	297
Preparing and checking before winter .....	167
Warning light .....	272
<b>Bottle holders</b> .....	186
<b>Brake</b>	
Fluid .....	314
Parking brake .....	143
Warning light .....	272
<b>Brake assist</b> .....	162
<b>Break-in tips</b> .....	119
<b>Brightness control</b>	
Instrument panel light control .....	77

## C

<b>Care</b> .....	<b>194, 197</b>
Aluminum wheels.....	195
Exterior .....	194
Interior.....	197
Seat belts.....	198
<b>Chains</b> .....	<b>168</b>
<b>Child restraint system</b> .....	<b>53</b>
Infant seats, definition.....	54
Infant seats, installation .....	59
Convertible seat, definition .....	54
Convertible seat, installation .....	59, 60
Installing CRS with LATCH anchors.....	58
Installing CRS with seat belts.....	59
Installing CRS with top tether strap .....	63
Booster seats, definition .....	54
Booster seats, installation.....	62
<b>Child safety</b> .....	<b>52</b>
Airbag precautions.....	36
Back door precautions.....	95
Battery precautions.....	220
Child restraint system .....	53
How your child should wear the seat belt.....	29
Installing child restraints .....	57
Power window lock switch ....	113
Power window precautions... ..	114
Rear door child-protectors .....	92
Removed key battery precautions.....	242
Seat belt precautions.....	30
<b>Child-protectors</b> .....	<b>92</b>
<b>Cleaning</b> .....	<b>194, 197</b>
Aluminum wheels.....	195
Exterior .....	194
Interior.....	197
Seat belts.....	198

<b>Clock</b> .....	<b>80</b>
<b>Clutch</b> .....	<b>313</b>
<b>Condenser</b> .....	<b>218</b>
<b>Coolant</b> .....	<b>216</b>
Capacity.....	311
Checking.....	216
Preparing and checking before winter .....	167
<b>Cooling system</b> .....	<b>216</b>
Engine overheating.....	300
<b>CRS (Child Restraint System)</b> .....	<b>53</b>
<b>Cruise control</b> .....	<b>158</b>
Warning lights.....	274
<b>Cup holders</b> .....	<b>185</b>
<b>Curtain shield airbags</b> .....	<b>34</b>
<b>Customizable features</b> .....	<b>333</b>

## D

<b>Defogger</b>	
Outside rear view mirrors .....	176
Rear window .....	176
Windshield.....	175
<b>Dimensions</b> .....	<b>306</b>
<b>Display</b>	
Drive information .....	79
Multi-information display.....	78
<b>Do-it-yourself maintenance</b> ....	<b>206</b>
<b>Door lock</b>	
Back door .....	94
Side doors .....	89
Wireless remote control.....	85
<b>Doors</b>	
Back door .....	94
Door glasses.....	113
Door lock .....	91
Open door warning buzzer ...	274
Open door warning light .....	274
Outside rear view mirrors .....	111
Rear door child-protector.....	92
Side doors .....	89
Side windows.....	113

<b>Driver's seat belt reminder</b>	
<b>light</b> .....	<b>274</b>
<b>Driving</b> .....	<b>116</b>
Break-in tips.....	119
Correct driving posture .....	24
Procedures .....	116
Winter drive tips.....	167

## E

<b>Eco Driving Indicator Light</b> .....	<b>120</b>
<b>Electric Power Steering</b>	
<b>(EPS)</b> .....	<b>162</b>
Function .....	162
Warning light.....	273
<b>Emergency flashers</b> .....	<b>262</b>
<b>Emergency, in case of</b>	
If the engine will not start.....	294
If the shift lever cannot be shifted from P .....	296
If the vehicle battery is discharged.....	297
If the warning buzzer sounds.....	272
If the warning light turns on .....	272
If you have a flat tire .....	281
If you lose your keys .....	86
If you think something is wrong.....	270
If your vehicle becomes stuck.....	303
If your vehicle has to be stopped in an emergency ...	263
If your vehicle needs to be towed.....	265
If your vehicle overheats.....	300

<b>Engine</b>	
"ACC" position .....	136
Compartment.....	213
Engine switch .....	136
Hood.....	209
How to start the engine.....	136
Identification number .....	308
If the engine will not start.....	294
If your vehicle has to be stopped in an emergency ...	263
Ignition switch (engine switch) .....	136
Overheating .....	300
<b>Engine coolant</b> .....	<b>216</b>
Capacity.....	311
Checking.....	216
Preparing and checking before winter .....	167
<b>Engine coolant temperature</b> <b>warning light</b> .....	<b>272</b>
<b>Engine immobilizer system</b> .....	<b>67</b>
<b>Engine oil</b> .....	<b>214</b>
Capacity.....	310
Checking.....	214
Preparing and checking before winter .....	167
<b>Engine switch</b>	
<b>(ignition switch)</b> .....	<b>136</b>
<b>EPS (Electric Power</b>	
<b>Steering)</b> .....	<b>162</b>
Function .....	162
Warning light.....	273
<b>Event data recorder</b> .....	<b>8</b>

**F**

<b>Flat tire</b> .....	<b>281</b>
<b>Floor mats</b> .....	<b>22</b>
<b>Fluid</b>	
Automatic transmission.....	312
Brake .....	314
Clutch.....	313
Washer .....	221
<b>Fog lights</b> .....	<b>147</b>
Replacing light bulbs.....	251
Switch .....	147
Wattage .....	316
<b>Front passenger's seat belt reminder light</b> .....	<b>274</b>
<b>Front seats</b> .....	<b>98</b>
Adjustment.....	98
Cleaning.....	197
Correct driving posture .....	24
Head restraints .....	104
<b>Front side marker lights</b> .....	<b>144</b>
Light switch .....	144
Replacing light bulbs.....	253
Wattage .....	316
<b>Front turn signal lights</b> .....	<b>142</b>
Replacing light bulbs.....	254
Turn signal lever .....	142
Wattage .....	316
<b>Fuel</b>	
Capacity.....	310
Fuel gauge.....	76
Fuel pump shut off system.....	271
Information .....	317
Refueling.....	155
Type.....	155, 310
Warning light.....	274

**Fuel consumption**

Average fuel consumption .....	80
Instantaneous fuel consumption.....	80
<b>Fuel filler door</b> .....	<b>155</b>
Refueling .....	155
<b>Fuel pump shut off system</b> .....	<b>271</b>
<b>Fuses</b> .....	<b>243</b>

**G**

<b>Gas station information</b> .....	<b>364</b>
<b>Gauges</b> .....	<b>76</b>
<b>Glove box</b> .....	<b>185</b>

**H****Hazard lights**

Switch .....	262
<b>Head restraints</b> .....	<b>104</b>
<b>Headlights</b> .....	<b>144</b>
Light switch.....	144
Replacing light bulbs .....	249
Wattage .....	316
<b>Heaters</b> .....	<b>172</b>
Manual air conditioning system.....	172
Outside rear view mirrors .....	176
<b>High mounted stoplight</b>	
Replacing light bulbs .....	258
<b>Hood</b> .....	<b>209</b>
Open.....	209
<b>Hooks</b>	
Retaining hooks (floor mat) ....	22
<b>Horn</b> .....	<b>107</b>

**I**

<b>Identification .....</b>	<b>307</b>
Engine.....	308
Vehicle.....	307
<b>Ignition switch</b>	
<b>(engine switch).....</b>	<b>136</b>
<b>Illuminated entry system .....</b>	<b>183</b>
<b>Immobilizer system .....</b>	<b>67</b>
<b>Indicators .....</b>	<b>74</b>
<b>Initialization</b>	
Maintenance data .....	201
Items to initialize .....	335
Tire pressure warning	
system.....	224
<b>Inside rear view mirror .....</b>	<b>109</b>
<b>Instrument panel light</b>	
<b>control.....</b>	<b>77</b>
<b>Interior light.....</b>	<b>182</b>
Switch .....	182
Wattage .....	316

**J**

<b>Jack</b>	
Positioning a floor jack.....	211
Vehicle-equipped jack.....	282
<b>Jack handle .....</b>	<b>282</b>

**K**

<b>Keyless entry</b>	
Wireless remote control .....	85
<b>Keys .....</b>	<b>84</b>
Engine switch.....	136
If you lose your keys .....	86
Ignition switch .....	136
Key number plate.....	84
Keyless entry .....	85
Replacing the battery.....	240
Wireless remote control	
key.....	85

**L**

<b>LATCH anchors .....</b>	<b>58</b>
<b>Lever</b>	
Auxiliary catch lever.....	209
Hood lock release lever .....	209
Shift lever.....	139, 141
Turn signal lever .....	142
Wiper lever .....	149, 152
<b>License plate lights .....</b>	<b>144</b>
Light switch.....	144
Replacing light bulbs .....	256
Wattage .....	316
<b>Light bulbs</b>	
Replacing.....	248
Wattage .....	316
<b>Lights</b>	
Fog light switch.....	147
Headlight switch .....	144
Illuminated entry system .....	183
Interior light.....	182
Interior lights list.....	182
Luggage compartment	
light.....	95
Personal lights .....	183
Replacing light bulbs .....	248
Turn signal lever .....	142
Wattage .....	316
<b>Lock steering column .....</b>	<b>137</b>
<b>Luggage cover .....</b>	<b>188</b>

**M****Maintenance**

- Do-it-yourself maintenance... 206
- Maintenance data ..... 306
- Maintenance requirements ... 200

**Malfunction indicator lamp..... 273****Manual transmission..... 141**

- Oil ..... 313

**Meter ..... 76**

- Indicators ..... 74
- Instrument panel light control..... 77
- Meters..... 76
- Multi-information display ..... 78
- Warning lights ..... 73

**Mirrors**

- Inside rear view mirror ..... 109
- Outside rear view mirror defoggers ..... 176
- Outside rear view mirrors..... 111
- Vanity mirrors..... 190

**Multi-information display..... 78****O****Odometer..... 79****Oil**

- Engine oil..... 310
- Manual transmission oil ..... 313

**Opener**

- Back door..... 94
- Fuel filler door ..... 155
- Hood ..... 209

**Outside rear view mirrors..... 111**

- Adjusting and folding ..... 111
- Outside rear view mirror defoggers ..... 176

**Overheating..... 300****P****Parking brake..... 143**

- Operation ..... 143
- Parking brake engaged warning buzzer..... 272

**Personal lights..... 183**

- Switch ..... 183
- Wattage ..... 316

**Power outlet..... 191****Power steering..... 162**

- Warning light..... 273

**Power windows ..... 113**

- Operation ..... 113
- Window lock switch ..... 113

**R****Radiator..... 218****Rear seat ..... 101**

- Folding down the rear seatbacks ..... 101

**Rear side marker lights..... 144**

- Light switch..... 144
- Replacing light bulbs ..... 255
- Wattage ..... 316

**Rear turn signal lights ..... 142**

- Replacing light bulbs ..... 255
- Turn signal lever ..... 142
- Wattage ..... 316

**Rear view mirror**

- Inside rear view mirror ..... 109
- Outside rear view mirrors ..... 111

**Rear window defogger..... 176****Rear window wiper..... 152****Refueling ..... 155**

- Capacity..... 310
- Fuel types ..... 155, 310
- Opening the fuel tank cap..... 157

**Replacing**

- Fuses..... 243
- Light bulbs ..... 248
- Tires..... 281
- Wireless remote control battery ..... 240



**Reset the maintenance data**..... 201

## S

**Seat belt reminder light**..... 274

**Seat belts**..... 26

Child restraint system  
installation ..... 57

Cleaning and maintaining  
the seat belt..... 198

Emergency Locking Retractor  
(ELR) ..... 29

How to wear your seat belt ..... 26

How your child should wear  
the seat belt..... 29

Pregnant women, proper  
seat belt use ..... 31

Reminder light and buzzer ..... 274

Seat belt pretensioners ..... 29

SRS warning light ..... 273

**Seats** ..... 98, 101

Adjustment..... 98

Adjustment precautions ..... 100

Child seats/child restraint  
system installation ..... 57

Cleaning..... 197

Folding down the rear  
seatbacks ..... 101

Head restraints ..... 104

Properly sitting in the seat ..... 24

**Shift lever** ..... 139, 141

Automatic transmission..... 139

If the shift lever cannot  
be shifted from P ..... 296

Manual transmission..... 141

**Shift lock system** ..... 296

**Side airbags** ..... 34

**Side doors** ..... 89

**Side mirrors** ..... 111

Adjusting and folding ..... 111

**Snow tires** ..... 167

**Spare tire**..... 282

Inflation pressure ..... 315

Storage location..... 282

**Spark plug**..... 312

**Specifications** ..... 306

**Speedometer**..... 76

**Steering lock**..... 137

**Steering wheel** ..... 107

Adjustment..... 107

Audio switches..... 180

**Stop lights**

Replacing light bulbs ..... 255

Wattage ..... 316

**Storage feature** ..... 184

**Stuck**

If the vehicle becomes  
stuck ..... 303

**Sun visors** ..... 190

**Switches**

Audio remote control  
switches ..... 180

Cruise control switch ..... 158

Door lock switches..... 91

Emergency flashers switch... 262

Engine switch ..... 136

Fog light switch..... 147

Hazard switch ..... 262

Ignition switch..... 136

Light switch..... 144

Outside rear view mirror  
switches ..... 111

Power door lock switch..... 91

Power window switches..... 113

Rear window defogger  
switch ..... 176

Rear window wiper and  
washer switch..... 152

Tire pressure warning  
reset switch ..... 225

VSC OFF switch ..... 163

Window lock switch ..... 113

Windshield wipers and  
washer switch..... 149

## T

<b>Tachometer</b> .....	76
<b>Tail lights</b> .....	144
Light switch .....	144
Replacing light bulbs.....	255
Wattage .....	316
<b>Theft deterrent system</b>	
Engine immobilizer system .....	67
<b>Tire inflation pressure</b> .....	231
Maintenance data .....	315
Warning light.....	274
<b>Tire pressure warning system</b> .....	224
Function .....	224
Initializing .....	224
Installing tire pressure warning valves and transmitters.....	224
Registering ID codes .....	225
Tire pressure warning reset switch .....	225
Warning light.....	274
<b>Tires</b> .....	223
Chains.....	168
Checking.....	223
If you have a flat tire .....	281
Inflation pressure .....	315
Replacing.....	281
Rotating tires.....	223
Size.....	315
Snow tires .....	169
Spare tire .....	281
Tire pressure warning reset switch .....	225
Warning light.....	274

<b>Tools</b> .....	282
<b>Top tether strap</b> .....	63
<b>Towing</b>	
Emergency towing .....	265
Dinghy towing .....	133, 134
Towing eyelet .....	267
Trailer towing .....	132
<b>Traction control</b> .....	162
<b>Transmission</b> .....	139, 141
Automatic transmission .....	139
If the shift lever cannot be shifted from P .....	296
Manual transmission.....	141
<b>Trip meters</b> .....	79
<b>Turn signal lights</b> .....	142
Replacing light bulbs.....	254, 255
Turn signal lever.....	142
Wattage .....	316

## U

<b>USB port</b> .....	181
-----------------------	-----

## V

<b>Vanity mirrors</b> .....	190
<b>Vehicle data recordings</b> .....	7
<b>Vehicle identification number</b> .....	307
<b>Vehicle Stability Control (VSC)</b> .....	162
<b>VSC (Vehicle Stability Control)</b> .....	162

## W

### Warning buzzers

Brake system .....	272
Key reminder .....	137
Open door .....	274
Seat belt reminder .....	274

### Warning lights..... 73

ABS.....	273
Brake system .....	272
Charging system.....	272
Cruise control indicator .....	274
Electric power steering system.....	273
High engine coolant temperature .....	272
Low engine oil pressure.....	272
Low fuel level .....	274
Malfunction indicator lamp .....	273
Open door .....	274
Seat belt reminder light.....	274
Slip indicator .....	273
SRS .....	273
Tire pressure.....	274

### Washer ..... 149, 152

Checking.....	221
Preparing and checking before winter .....	167
Switch .....	149, 152

### Washing and waxing..... 194

### Weight ..... 306

### Wheels..... 235

Replacing.....	235
Size.....	315

### Window glasses ..... 113

### Window lock switch ..... 113

### Windows..... 113

Power windows.....	113
Rear window defogger.....	176
Washer .....	149

### Windshield wipers..... 149

### Winter driving tips..... 167

### Wireless remote control

key .....	85
Locking/Unlocking .....	85
Replacing the battery.....	240

## GAS STATION INFORMATION

Auxiliary catch lever

P. 209

Fuel filler door

P. 157

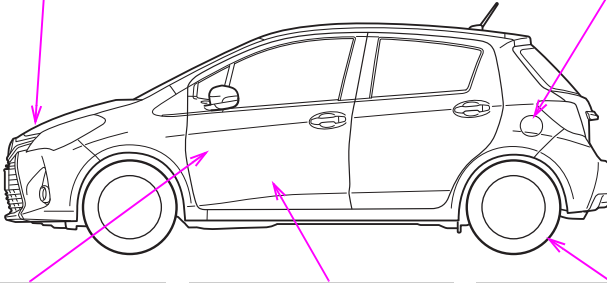

STOPIAP036

Hood lock release  
lever

P. 209

Fuel filler door opener

P. 157

Tire inflation pressure

P. 315

Fuel tank capacity  
(Reference)

11.1 gal. (42 L, 9.2 Imp.gal.)

Fuel type

Unleaded gasoline, Octane Rating 87  
(Research Octane Number 91) or higherCold tire inflation  
pressure

P. 315

Engine oil capacity  
(Drain and refill —  
reference)With filter  
Without filterqt. (L, Imp.qt.)  
3.9 (3.7, 3.3)  
3.6 (3.4, 3.0)

Engine oil type

P. 310